

Microwave USB Power Sensors

MA24108A, True-RMS, 10 MHz to 8 GHz

MA24118A, True-RMS, 10 MHz to 18 GHz

MA24126A, True-RMS, 10 MHz to 26 GHz

Low Cost, Compact, and Highly Accurate Power Sensors
for RF and Microwave Applications



MA24108A and MA24118A at a Glance

Feature	Benefit
Broad Frequency Range (10 MHz to 26 GHz)	Ideal for General Purpose, Aerospace and Defense, Satellite and Cellular applications
True RMS Measurements over 60 dB Dynamic Range	Enables average power measurement of signals with bandwidths beyond 100 MHz
NIST Traceable Calibration	Provides traceable measurements needed for Aerospace and Defense applications
Built-in Internal and External Trigger	Facilitates multislot and burst power measurements (for example, GSM, WiMAX, TD-SCDMA)
Easy to Use with PC or Select Anritsu Handhelds	No benchtop power meter unit needed
Silicon Protective Covering (removable)	Provides additional field durability
1 mW Calibration Need Eliminated	Reduces test time and handling in production
Worldwide Calibration and Service Centers	Ensure reduced downtime and quick support

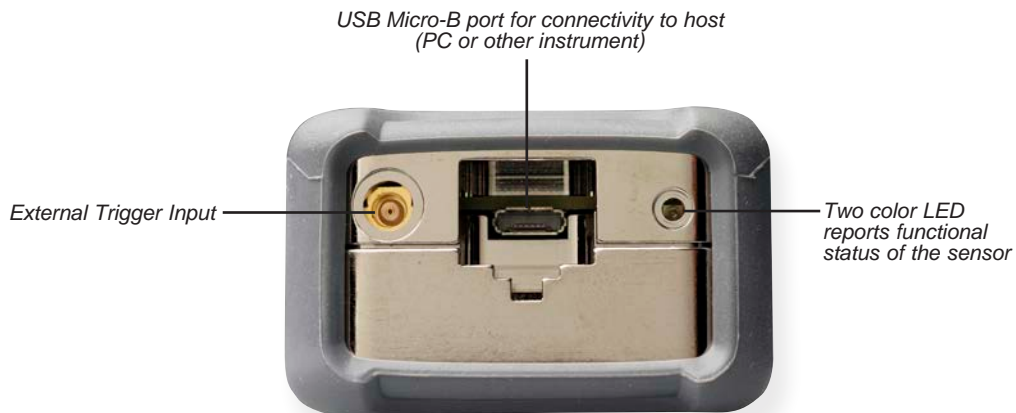

N connector designed for use with a torque wrench ensures repeatable connections

Dual-path Architecture provides True-RMS Measurements

The MA24108A, MA24118A and MA24126A USB Power sensors are designed to provide accurate average power measurements from 10 MHz to 26 GHz over 60 dB of dynamic range. The sensors employ a “dual path” architecture that provides (similar to thermal sensor) True-RMS measurements over the entire frequency and dynamic range, enabling users to make highly accurate average power measurements for CW, multi-tone, and digitally modulated signals up to 26 GHz.

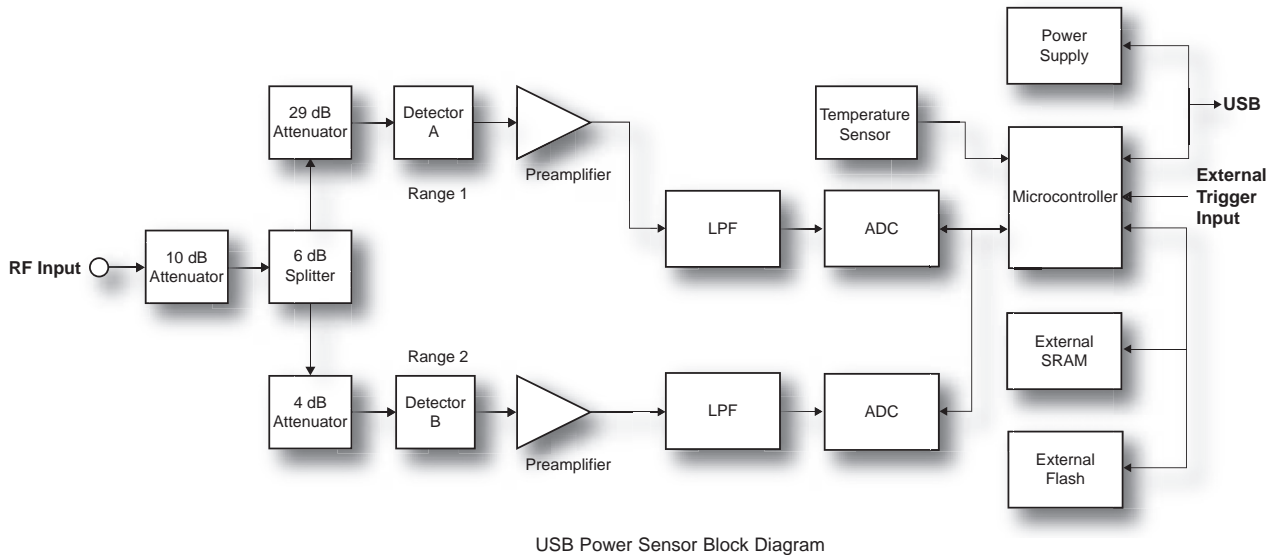

Highly accurate modulation measurements are facilitated by keeping the diode detectors in the “square law region” and by choosing the output of the appropriate detector path. A built-in attenuator provides excellent SWR performance, thus minimizing mismatch error. The sensor has built-in external trigger (in addition to a software based internal trigger) circuitry with an MCX connector interface to receive trigger from external stimuli for reliable analysis of very complex timeslot configurations. The presence of a micro-controller along with signal conditioning circuitry, ADC, and power supply in the sensor makes it a complete miniature power meter. All calibration factors, as well as linearity and temperature corrections, are stored inside the sensor. To ensure high accuracy, the standards that are used to calibrate this sensor are directly traceable to the US National Institute of Standards and Technology (NIST), and periodic calibrations are supported by Anritsu service centers worldwide.



General Purpose and Defense Testing

High Accuracy for R&D use

The MA24108A, MA24118A and MA24126A USB power sensors are ideal for R&D of general purpose and wireless devices and systems due to their low cost, ability to measure a variety of RF and microwave waveforms, wide dynamic range, and power accuracy. Their compact size saves space by replacing traditional benchtop instruments. True-RMS power measurements of modulated signals are made effortlessly with no limits on modulation bandwidths.

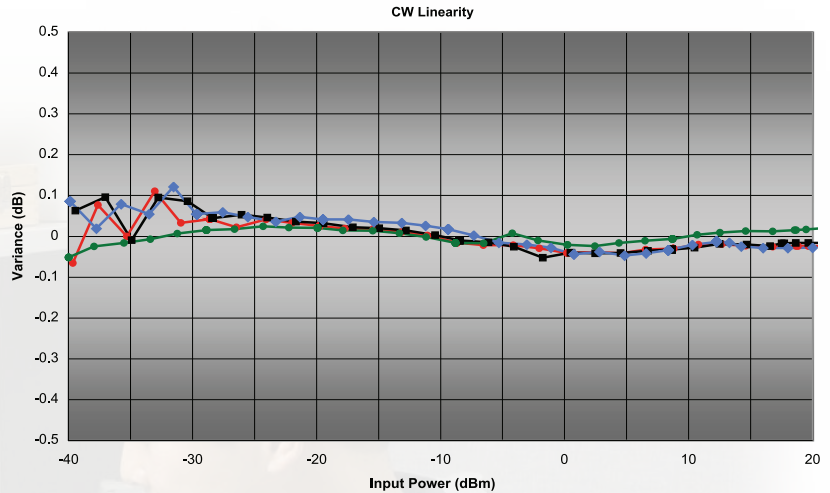

Measurement linearity error referenced to an ideal thermal power sensor measurement of CW signals operating at 2 GHz (green trace), 8 GHz (red trace), 18 GHz (black trace) and 26 GHz (blue trace).

Optimized for Production

MA24108A, MA24118A and MA24126A facilitate lab quality measurements on the production floor for a fraction of cost of existing solutions enabling better test margins. Because the sensor is connected directly to the PC, no base unit is needed, saving valuable rack space. The ability of the sensor to receive external trigger from other instruments, such as signal or function generators, enables its use in complex ATE system applications. The sensor measurement speed can be optimized via features such as auto averaging and auto ranging for best accuracy and noise performance, thus making it suitable for a wide variety of ATE applications. Multiple sensors can be connected and can be controlled remotely via a single PC, allowing flexibility to match specific measurement need.

A software toolkit is supplied with every sensor and contains a sample program with source code for controlling the sensor in ATE environments. The reference calibrator (50 MHz, 1 mW) typically needed by power meters has also been eliminated because the connecting USB cable transfers only digital data (corrected power), minimizing test station complexity and sensor handling, and reducing test times.

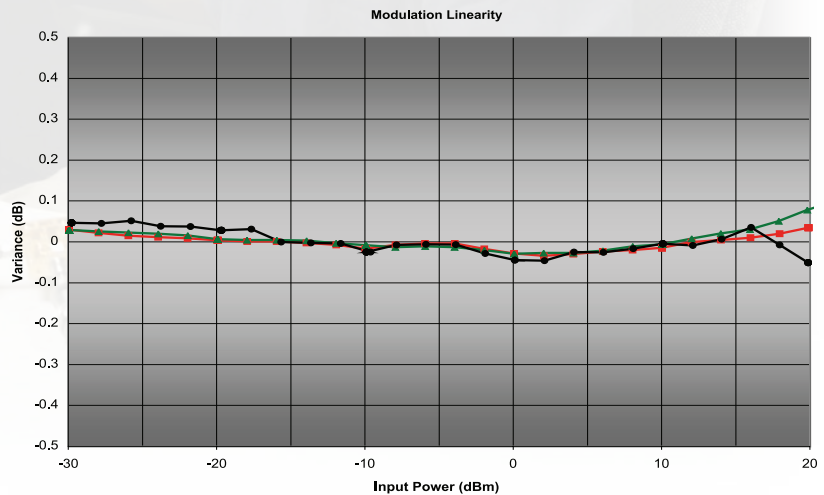

Measurement linearity error referenced to an ideal thermal power sensor measurement at 2 GHz of Wimax (green trace), CDMA2000 (red trace) and four slot GSM (black trace) signals.

RF and Microwave Communication Systems Testing

Ideal for Field

MA24108A, MA24118A and MA24126A power sensors provide lab performance accuracy in a rugged and compact field solution. The sensor accuracy is assured over a wide temperature range (0 °C to 55 °C), making it ideal for cellular base station and microwave point-to-point radio installation and maintenance applications. Field and service technicians will appreciate the small size and light weight of this standalone unit because they can carry it in their shirt pocket or laptop case. A very easy to use PC application with a large display makes operation straightforward for users with limited training. The high damage level (+33 dBm) and ESD protection provide ruggedness to this high performance sensor. Presence of DC block at the front end of the sensor protects it from RF signals carrying DC power content. Because these sensors are designed for low power requirements, laptop battery life is preserved.



Remote Monitoring via LAN

Because the USB cable that is connected to the sensor transfers only corrected power back to the host, a 1 mW reference calibrator is not required. However, USB data transfer capabilities limit the cable length to 5 meters, which prohibits any remote monitoring. This limitation can be overcome by installing any generic low cost USB-to-LAN hub converter (for example, a Belkin FL5009) at the measurement site along with the sensors. In this way, power monitoring can be performed across continents, if desired.

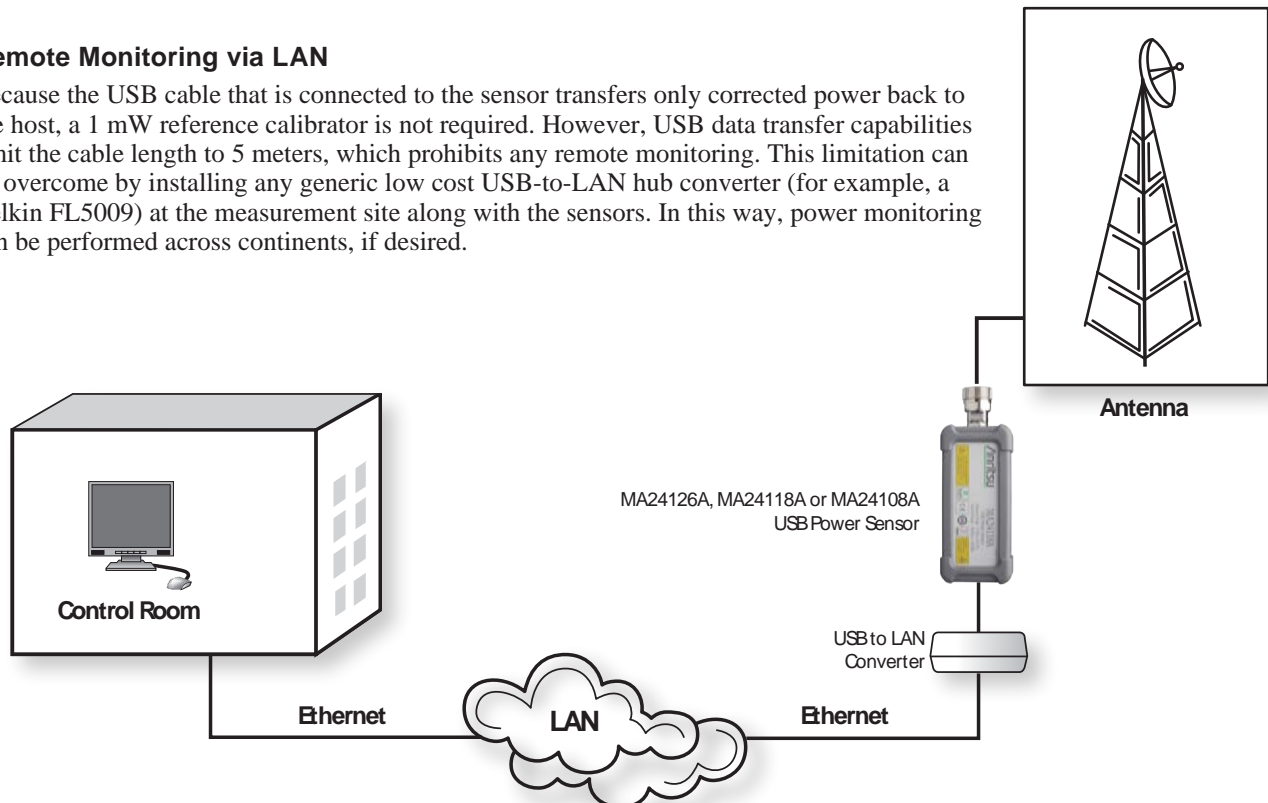

Antenna measurements over long distance via LAN or Ethernet

Compact and Powerful

The MA24108A, MA24118A and MA24126A sensors have the ability to internally trigger (acquire the trigger from signal under test) or receive an external trigger signal. The triggering capabilities of the power sensor can be exploited in the Scope and the Time Slot modes (via PowerXpert or remote programming commands) of the sensor that enable power measurements on signal bursts and within individual timeslots of TDMA systems, respectively. The sensor ADC can sample RF waveforms at 140,000 samples per second with a Capture Time of up to 300 ms. Negative trigger delay can be introduced to analyze pre-trigger waveform events. Positive trigger delay is especially useful for analysis of non-periodic waveforms.

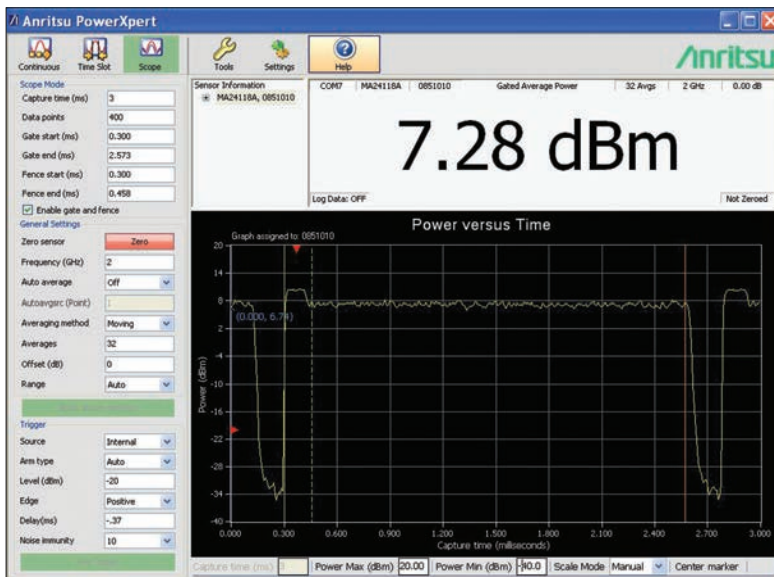

Scope Measurements

In scope mode, the sensor is triggered internally or externally to display power measurements with respect to time. Measurement of noisy or modulated signals can be challenging because the trigger can occur at a wrong point or at a wrong edge. To provide immunity against noise and modulation effects, a noise immunity factor and trace averaging can be adjusted. A Gate and Fence feature enables measurement of the desired portion of the waveform. All points that fall within the gate are measured, and points that fall within the fence are rejected. This feature is particularly useful when measuring waveforms that contain very short duty cycle timing information that otherwise skews average power measurement.

Measurement of average power of a WIMAX burst while excluding the effects of preamble via gate and fence feature of MA24118A using PowerXpert.



Time Slot Measurements

Time Slot mode operation is generally useful when doing measurement on TDMA waveforms such as GSM/EDGE. The slot mode breaks up the measurement in time slots and calculates the average power reading for each individual slot. Similar to the scope mode, measurements are internally or externally triggered. The sensor has built-in external trigger circuitry with an MCX connector interface to receive trigger from external stimuli for reliable analysis of very complex timeslot configurations. The sensor has the ability to support up to 128 slots intervals and 300 ms total Capture Time. This feature allows entire frames of many types of communication signals to be analyzed. Similar to the scope mode, the unwanted portions in the transition from one timeslot to the next can be masked by user-definable exclusion periods.

Measurement of a GSM four slot waveform with a MA24118A and PowerXpert in Time Slot mode

Compatibility

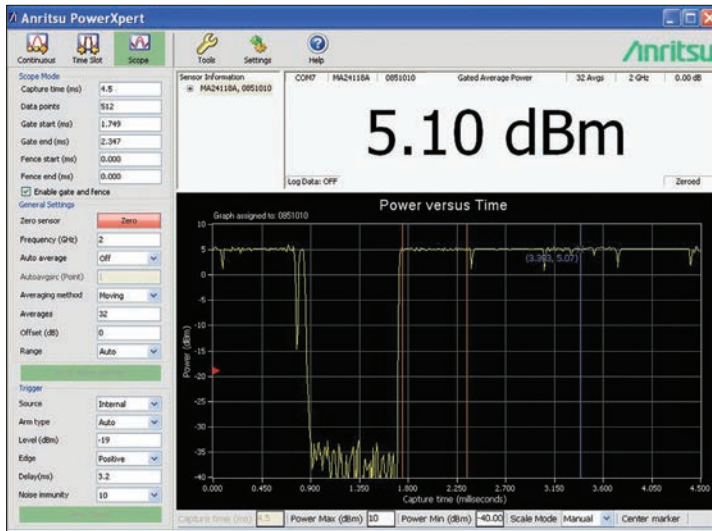

Measurement of average power in slot 4 of TD-SCDMA waveform via time gating feature of MA24118A using PowerXpert.



MA24118A with PC Laptop

These power sensors can be used with a PC running Microsoft Windows® via USB. They come with PowerXpert™ application, a data analysis, and control software. A front panel display makes the PC appear like a traditional power meter. The application has abundant features, such as data logging, power versus time graph, big numerical display, and many more, that enable quick and accurate measurements.

The power sensors are also compatible with an Option-19-enabled Site Master™ (S3xxE), Spectrum Master™ (MS271xE and MS2720T), Cell Master™ (MT821xE), BTS Master™ (MT822xB), VNA Master™ (MS202xA/B and MS203xA) and Economy Benchtop Microwave Spectrum Analyzers (MS271xB) family of instruments. The power sensor easily connects to these instruments via a USB A/micro-B cable, turning each of them into a virtual power meter that displays average power of signal under test. Users interested in making measurements in Timeslot mode and Scope mode must use a PC instead (PowerXpert or remote programming commands).



MA24126A with MT8213E Cell Master™

Specifications

	MA24108A	MA24118A	MA24126A
Sensor			
Frequency range	10 MHz to 8 GHz	10 MHz to 18 GHz	10 MHz to 26 GHz
Dynamic range (CW)	-40 dBm to +20 dBm		
Dynamic range (Timeslot)	-40 dBm to +20 dBm		
Dynamic range (Scope)	-40 dBm to +20 dBm		
SWR	< 1.17, 10 MHz to 150 MHz < 1.12, 150 MHz to 2 GHz < 1.22, 2 GHz to 8 GHz	< 1.17, 10 MHz to 150 MHz < 1.12, 150 MHz to 2 GHz < 1.22, 2 GHz to 12 GHz < 1.25, 12 GHz to 18 GHz	< 1.90, 10 MHz to 50 MHz < 1.17, 50 MHz to 150 MHz < 1.12, 150 MHz to 2 GHz < 1.22, 2 GHz to 12 GHz < 1.25, 12 GHz to 18 GHz < 1.35, 18 GHz to 26 GHz
Signal channel rise time	8 μ s typical		
Video bandwidth	50 kHz typical		
Sampling rate	140 ks/s, typical		
Measurement ranges	Range 1, +20 dBm to -7 dBm typical Range 2, -7 dBm to -40 dBm typical Auto ranging between range 1 and 2		
Measurement Uncertainty			
Linearity	< 3%		
Cal factor ¹	< 2.3% at 10 MHz < 1.5%, 50 MHz to 8 GHz	< 2.3% at 10 MHz < 1.5%, 50 MHz to 18 GHz	< 3.5% at 10 MHz < 2.0%, 50 MHz to 2 GHz < 2.5%, 3 GHz to 8 GHz < 3.0%, 9 GHz to 15 GHz < 3.5%, 16 GHz to 26 GHz
Noise ²	< 8 μ W, Range 1 < 40 nW, Range 2		
Zero set ³	< 1 μ W, Range 1 < 10 nW, Range 2		
Zero drift ⁴	< 0.5 μ W, Range 1 < 3 nW, Range 2		
Effect of temperature	< 1.4%		
Effect of digital modulation ⁵	< 0.5%, < +18 dBm < 1.4%, > +18 dBm		
System			
Measurand	Average power		
Measurement resolution ⁶	0.01 dB max via PowerXpert, 0.001 dB max via remote command		
Offset correction ⁷	-100 dB to +150 dB		
Averaging	Auto, Manual		
Type	Moving, Repeat		
Number of averages (manual) ⁸	1 to 40,000		
Auto average	Resolution ⁹	1 dB, 0.1 dB, 0.01 dB, 0.001 dB	
	Source (slot # or scope data point number)	Timeslot: 1 to 128 Scope: 1 to 1024	
Continuous Average Mode			
Duty Cycle correction	0.01% to 100%		
Aperture time	0.01 ms to 300 ms		
Measurement time ¹⁰	$N \times (\text{Capture Time} \times 2.5) + T_d + T_{com}$		
Scope Mode			
Capture time	0.01 to 300 ms		
Data points	1 to 1024		
Resolution	0.007 ms, max via remote command 0.01 ms, max via PowerXpert		
Measurement time ¹¹	$N \times (\text{Capture Time} \times 3.75) + (P_n \times T_{dp}) + T_{com}$		
Timeslot Mode			
Maximum number of slots	128		
Slot with	0.01 ms to 100 ms		
Maximum capture time	300 ms (slot width x number of slots)		
Resolution	0.007 ms, max via remote command 0.01 ms, max via PowerXpert		
Exclusion periods	Start exclusion	0 ms to 10 ms	
	End exclusion	0 ms to 10 ms	
Measurement time ¹¹	$N \times (\text{Capture Time} \times 3.75) + (P_n \times T_{dp}) + T_{com}$		

Specifications

Trigger	
Source ¹²	Bus, Continuous, Internal and External
Internal Trigger	
Dynamic range	-20 dBm to +20 dBm
Level accuracy	± 0.5 dB, typical
Slope	Positive or negative
Delay range	-5 ms to +10 s
Delay resolution	10 µs
External Trigger	
Impedance	100 kΩ
Type	TTL/CMOS
Slope	Positive or negative
Delay range	-5 ms to +10 s
Delay resolution	10 µs
Positive threshold voltage	2.0 V typical
Negative threshold voltage	1.2 V typical
Hysteresis	0.8 V typical
General	
RF connector	N male, K male (MA24126A)
Interface to host	USB 2.0 full speed (compatible with USB 1.0 and 1.1)
Current consumption	150 mA, typical
External trigger input	MCX (female), 12 V max
Damage levels at RF port	+33 dBm, ± 20 V DC
Size	25 mm x 45 mm x 110 mm, excluding N connector and silicone protective covering
Weight	230 g (0.51 lb)
Environmental ¹³	
Operating temperature range	0 °C to 55 °C
Storage temperature range	-51 °C to +71 °C
Humidity	45% relative humidity at 55 °C (non-condensing) 75% relative humidity at 40 °C (non-condensing) 95% relative humidity at 30 °C (non-condensing)
Shock	30 g half-sine, 11 ms duration
Vibration	Sinusoidal: 5 Hz to 55 Hz, 3 g max. Random: 10 Hz to 500 Hz Power Spectral Density: 0.03 g ² /Hz
EMC	EN 61326, EN 55011
Safety	EN 61010-1
PowerXpert v2.0 (PC requirements)	
Processor and RAM	Minimum: Equivalent to Intel® Pentium® III with 1 GB RAM or Intel® Pentium® IV with 512 MB RAM Recommended: Equivalent to Intel® Pentium® IV with 1 GB RAM
Operating system	Microsoft® Windows 7, Windows Vista®, Windows XP and Windows 2000
Hard-disk free space	100 MB, minimum
Display resolution	1024 × 768, minimum
Interface	USB 2.0 full speed (compatible with USB 1.0 and 1.1)

Notes:

All specs are applicable after twenty minutes warm-up at room temperature unless specified otherwise.

- Expanded uncertainty with K=2 for absolute power measurements on CW signal at 0 dBm and calibration frequencies 10 MHz, 50 MHz, 100 MHz, 300 MHz, 500 MHz, and 1 GHz to 8 GHz (for MA24108A), or to 18 GHz (MA24118A) or to 26 GHz (for MA24126A) in 1 GHz increments..
- Expanded uncertainty with K=2 after zero operation when measured with 1 average, and 20 ms aperture time for 5 minutes. Effect of Noise can be reduced by increasing the number of averages and/or increasing the aperture time. Noise goes down as square root of number of averages and aperture time. For example with 128 averages, the Noise is 3.5 nW (40 nW divided by $\sqrt{128}$). Effect of increased aperture time is calculated in the same way.
- Expanded uncertainty with K=2 after zero operation when measured with 1 average, and 20 ms aperture time for 5 minutes.
- Expanded uncertainty with K=2 after one hour warm-up and zero operation, 1 average, 20 ms aperture time, and keeping the temperature within ±1 °C.
- Measurement error with reference to a CW signal of equal power and frequency at 25 °C.
- Resolution in PowerXpert application is 2 digits after the decimal. Native resolution of the sensor is 3 digits after the decimal.
- Offset correction feature is available only through PowerXpert application. There is no remote command for it in the sensor firmware.
- Maximum number of averages allowed in Continuous Average mode and Timeslot mode is 40,000. In scope, the maximum number of averages is equal to 8231936 divided by data points.
- Averaging resolution of 0.001 dB is not available with PowerXpert application. It is defined as the place after the decimal to which the reading becomes stable. E.g. if 0.01 is selected then the reading will typically be stable ± 0.01 dB. Please refer to the remote operation chapter in the user guide for information regarding access to this feature.
- Speed is defined as the data throughput at the "A" end of the USB A to Micro-B Cable (p/n 2000-1606-R). T_d is the delay compensation for smaller Capture Times, $T_d = 0$ for Capture Time >9 ms, $T_d = 3$ ms for 2 ms < Capture Time <9 ms, $T_d = 5$ ms for Capture Time < 2 ms, $T_{com} = 5$ ms, command processing time.
- Speed is defined as the data throughput at the "A" end of the USB A to Micro-B Cable (p/n 2000-1606-R). Where N is the number of repeat averages, N = 1 for moving average mode, P_n = Number of points, $T_{dp} = 0.05$ ms (Communication delay (approx) due to each point), $T_{com} = 5$ ms, command processing time.
- Bus trigger not available in PowerXpert application.
- Tests were performed per MIL-PRF-28800F (Class 2).

Ordering Information

MA24108A	8 GHz USB Power Sensor
MA24118A	18 GHz USB Power Sensor
MA24126A	26 GHz USB Power Sensor

Included Accessories

Model	Description
2300-283	Product CD—Anritsu PowerXpert and USB Power Sensors
10585-00021	Quick Start Guide
2000-1605-R	1.5 m BNC (m) to MCX (m) cable
2000-1606-R	1.8 m USB A to Micro-B cable with latch

Available Options

Option Number	Description
MA24108A-097	Option 97, Accredited Calibration to ISO17025 and ANSI/NCSL Z540. Test report and uncertainty data included.
MA24108A-098	Option 98, Standard calibration to ISO17025 and ANSI/NCSL Z540
MA24108A-099	Option 99, Premium calibration to ISO17025 and ANSI/NCSL Z540. Test report and uncertainty data included.
MA24118A-097	Option 97, Accredited Calibration to ISO17025 and ANSI/NCSL Z540. Test report and uncertainty data included.
MA24118A-098	Option 98, Standard calibration to ISO17025 and ANSI/NCSL Z540
MA24118A-099	Option 99, Premium calibration to ISO17025 and ANSI/NCSL Z540. Test report and uncertainty data included.
MA24126A-097	Option 97, Accredited Calibration to ISO17025 and ANSI/NCSL Z540. Test report and uncertainty data included.
MA24126A-098	Option 98, Standard calibration to ISO17025 and ANSI/NCSL Z540
MA24126A-099	Option 99, Premium calibration to ISO17025 and ANSI/NCSL Z540. Test report and uncertainty data included.

Optional Accessories

Calibrated Torque Wrenches

Model	Description
01-200	Calibrated torque wrench for N connector
01-204	Calibrated torque wrench for K and V connectors

Cables

Model	Description
2000-1614-R	5.0 m USB A to Micro-B cable with latch

Power Attenuators

Model	Frequency range	Rating	Connectors
3-1010-123	DC to 8.5 GHz	30 dB, 50 W, 50 Ω	N (m) to N (f)
3-1010-124	DC to 8.5 GHz	40 dB, 100 W, 50 Ω	N (m) to N (f)
3-1010-122	DC to 12.4 GHz	20 dB, 5 W, 50 Ω	N (m) to N (f)
42N50-20	DC to 18 GHz	20 dB, 5 W, 50 Ω	N (m) to N (f)
42N50-30	DC to 18 GHz	30 dB, 50 W, 50 Ω	N (m) to N (f)
41KB-3	DC to 26.5 GHz	3 dB, 50 Ω	K (m) to K (f)
41KB-6	DC to 26.5 GHz	6 dB, 50 Ω	K (m) to K (f)
41KB-10	DC to 26.5 GHz	10 dB, 50 Ω	K (m) to K (f)
41KB-20	DC to 26.5 GHz	20 dB, 50 Ω	K (m) to K (f)
43KB-3	DC to 26.5 GHz	3 dB, 50 Ω	K (m) to K (f)
43KB-6	DC to 26.5 GHz	6 dB, 50 Ω	K (m) to K (f)
43KB-10	DC to 26.5 GHz	10 dB, 50 Ω	K (m) to K (f)
43KB-20	DC to 26.5 GHz	20 dB, 50 Ω	K (m) to K (f)

Ordering Information

Precision Coaxial Adapters

Model	Frequency range	Connectors
510-90	DC to 3.3 GHz	N (m) to 7/16 DIN (f)
510-91	DC to 3.3 GHz	N (f) to 7/16 DIN (f)
510-92	DC to 3.3 GHz	N (m) to 7/16 DIN (m)
510-93	DC to 3.3 GHz	N (f) to 7/16 DIN (m)
33NMF50B	DC to 18 GHz	N (f) to N (f)
33NNF50B	DC to 18 GHz	N (m) to N (f)
33NN50B	DC to 18 GHz	N (m) to N (m)
34AN50	DC to 18 GHz	GPC-7 to N (m)
34ANF50	DC to 18 GHz	GPC-7 to N (f)
34NFK50	DC to 18 GHz	N (f) to K (m)
34NFKF50	DC to 18 GHz	N (m) to K (f)
34NK50	DC to 18 GHz	N (m) to K (m)
34NKF50	DC to 18 GHz	N (m) to K (f)
1091-26	DC to 18 GHz	N (m) to SMA (m)
1091-27	DC to 18 GHz	N (m) to SMA (f)
1091-80-R	DC to 18 GHz	N (f) to SMA (m)
1091-81-R	DC to 18 GHz	N (f) to SMA (f)

• **United States**

Anritsu Company

1155 East Collins Boulevard, Suite 100,
Richardson, TX, 75081 U.S.A.
Toll Free: 1-800-ANRITSU (267-4878)
Phone: +1-972-644-1777
Fax: +1-972-671-1877

• **Canada**

Anritsu Electronics Ltd.

700 Silver Seven Road, Suite 120,
Kanata, Ontario K2V 1C3, Canada
Phone: +1-613-591-2003
Fax: +1-613-591-1006

• **Brazil**

Anritsu Eletrônica Ltda.

Praça Amadeu Amaral, 27 - 1 Andar
01327-010 - Bela Vista - São Paulo - SP - Brazil
Phone: +55-11-3283-2511
Fax: +55-11-3288-6940

• **Mexico**

Anritsu Company, S.A. de C.V.

Av. Ejército Nacional No. 579 Piso 9, Col. Granada
11520 México, D.F., México
Phone: +52-55-1101-2370
Fax: +52-55-5254-3147

• **United Kingdom**

Anritsu EMEA Ltd.

200 Capability Green, Luton, Bedfordshire LU1 3LU, U.K.
Phone: +44-1582-433280
Fax: +44-1582-731303

• **France**

Anritsu S.A.

12 avenue du Québec, Batiment Iris 1-Silic 612,
91140 VILLEBON SUR YVETTE, France
Phone: +33-1-60-92-15-50
Fax: +33-1-64-46-10-65

• **Germany**

Anritsu GmbH

Nemetschek Haus, Konrad-Zuse-Platz 1
81829 München, Germany
Phone: +49 (0) 89 442308-0
Fax: +49 (0) 89 442308-55

• **Italy**

Anritsu S.r.l.

Via Elio Vittorini 129 00144 Roma Italy
Phone: +39-06-509-9711
Fax: +39-06-502-2425

• **Sweden**

Anritsu AB

Borgarfjordsgatan 13A, 164 40 KISTA, Sweden
Phone: +46-8-534-707-00
Fax: +46-8-534-707-30

• **Finland**

Anritsu AB

Teknobulevardi 3-5, FI-01530 Vantaa, Finland
Phone: +358-20-741-8100
Fax: +358-20-741-8111

• **Denmark**

Anritsu A/S (for Service Assurance)

Anritsu AB (for Test & Measurement)

Kay Fiskers Plads 9, 2300 Copenhagen S, Denmark
Phone: +45-7211-2200
Fax: +45-7211-2210

• **Russia**

Anritsu EMEA Ltd.

Representation Office in Russia

Tverskaya str. 16/2, bld. 1, 7th floor.
Russia, 125009, Moscow
Phone: +7-495-363-1694
Fax: +7-495-935-8962

• **United Arab Emirates**

Anritsu EMEA Ltd.

Dubai Liaison Office

P O Box 500413 - Dubai Internet City
Al Thuraya Building, Tower 1, Suite 701, 7th Floor
Dubai, United Arab Emirates
Phone: +971-4-3670352
Fax: +971-4-3688460

• **Singapore**

Anritsu Pte. Ltd.

60 Alexandra Terrace, #02-08, The Comtech (Lobby A)
Singapore 118502
Phone: +65-6282-2400
Fax: +65-6282-2533

• **India**

Anritsu India Private Limited

2nd & 3rd Floor, #837/1, Binnamangla 1st Stage,
Indiranagar, 100ft Road, Bangalore - 560038, India
Phone: +91-80-4058-1300
Fax: +91-80-4058-1301

• **P. R. China (Shanghai)**

Anritsu (China) Co., Ltd.

Room 1715, Tower A CITY CENTER of Shanghai,
No. 100 Zunyi Road, Chang Ning District,
Shanghai 200051, P.R. China
Phone: +86-21-6237-0898
Fax: +86-21-6237-0899

• **P. R. China (Hong Kong)**

Anritsu Company Ltd.

Unit 1006-7, 10/F., Greenfield Tower, Concordia Plaza,
No. 1 Science Museum Road, Tsim Sha Tsui East,
Kowloon, Hong Kong, P. R. China
Phone: +852-2301-4980
Fax: +852-2301-3545

• **Japan**

Anritsu Corporation

8-5, Tamura-cho, Atsugi-shi,
Kanagawa, 243-0016 Japan
Phone: +81-46-296-1221
Fax: +81-46-296-1238

• **Korea**

Anritsu Corporation, Ltd.

502, 5FL H-Square N B/D, 681,
Sampyeong-dong, Bundang-gu, Seongnam-si,
Gyeonggi-do, 463-400 Korea
Phone: +82-31-696-7750
Fax: +82-31-696-7751

• **Australia**

Anritsu Pty Ltd.

Unit 21/270 Ferntree Gully Road,
Notting Hill, Victoria 3168, Australia
Phone: +61-3-9558-8177
Fax: +61-3-9558-8255

• **Taiwan**

Anritsu Company Inc.

7F, No. 316, Sec. 1, Neihu Rd., Taipei 114, Taiwan
Phone: +886-2-8751-1816
Fax: +886-2-8751-1817

Please Contact:



Anritsu prints on recycled paper with vegetable soybean oil ink.



© Anritsu All trademarks are registered trademarks of their respective owners. Data subject to change without notice. For the most recent specifications visit: www.anritsu.com

Microwave USB Power Sensors PB
©2013 Anritsu Company, USA
All Rights Reserved.



11410-00504



D