

# FTB-700G Series

OPTICAL, ETHERNET AND MULTISERVICE TESTER



Feature(s) of this product is/are protected by one or more of patent appl. US 2012/0307666 A1 and equivalents in other countries.

SPEC SHEET

An all-in-ONE Ethernet/optical solution for field technicians installing, testing and troubleshooting FTTx, fronthaul, backhaul, small cell, DAS, remote radio head and data center networks, in addition to OTN, SONET/SDH, Fibre Channel, GigE and 10 GigE, CPRI/OBSAI and SyncE/1588 PTP services, with the added support of OTDR and iOLM capabilities.

## OPTICAL

- Dynamic range up to either 36 or 39 dB
- Test through high-port-count splitters (up to 1x128)
- Combined singlemode/multimode wavelengths
- Event dead zone as low as 0.8 meters
- iOLM-ready: one-touch multiple acquisitions, with clear go/no-go results presented in a straightforward visual format
- Integrated tool combines a visual fault locator, inspection probe, broadband power meter and a CW source mode

## MULTISERVICE

- SONET/SDH, OTN and Ethernet interfaces up to 11.3 Gbit/s
- Packet synchronization turn-up and troubleshooting (SyncE/1588 PTP)
- FTTA validation for CPRI from 1.2 Gbit/s to 9.8 Gbit/s via BER testing
- Efficiently assess Fibre Channel networks with best-in-class coverage via 1x, 2x, 4x, 8x and 10x interfaces
- OTN testing (as per ITU-T G.709)
- Ethernet service activation with bidirectional EtherSAM (ITU-T Y.1564) and RFC 2544 test suites, multistream traffic generation, Through mode and BER testing
- Carrier Ethernet OAM testing covering Y.1731, G.8113.1 (MPLS-TP), MEF and 802.1ag standards
- Full line-rate packet capture and advanced filtering from 10M to 10G
- Layer-2 transparency testing with predefined configurations
- True wire-speed, stateful TCP throughput test based on RFC 6349 for undisputable SLA enforcement of Ethernet services

## COMPLEMENTARY PRODUCTS



Platform  
FTB-1



Fiber Inspection Probe  
FIP-400B



Data Post-Processing Software  
FastReporter 2



## THE ULTRA-PORTABLE CHOICE FOR MULTISERVICE TESTING

The ongoing transition towards a converged network infrastructure for optical, SONET/SDH, OTN, Fibre Channel and packet-based Ethernet services requires a test tool that can cover a wide range of interfaces and rates without sacrificing portability, speed or cost. Leveraging the powerful FTB-1 handheld platform, the FTB-700G Series streamlines processes and empowers field technicians to efficiently test and validate optical networks, SONET/SDH, OTN, Fibre Channel and Ethernet circuits.

## THE BEST FROM OPTICAL, ETHERNET AND MULTI-TEST FEATURES

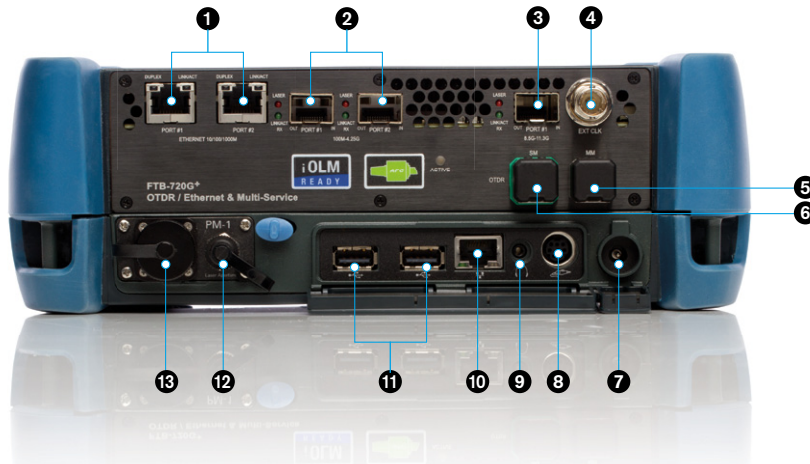

- 1 10M-1G Electrical Ports
- 2 100M-1G Optical Ports
- 3 10G Optical Port
- 4 External Clock Reference
- 5 OTDR Port (Multimode)
- 6 OTDR Port (Singlemode)
- 7 Power
- 8 Fiber Inspection Probe
- 9 Headset
- 10 Ethernet Management Port
- 11 USB Ports
- 12 Visual Fault Locator
- 13 Power Meter

## OPTICAL

### FIBER CONNECTOR INSPECTION AND CERTIFICATION - THE ESSENTIAL FIRST STEP



Taking the time to properly inspect a fiber-optic cable can prevent a slew of problems down the line—saving you time, money and headaches.

#### FIP-430B | The First Fully Automated Fiber Inspection Probe for the Field

Housing a unique automatic focus adjustment system, the FIP-430B automates each operation in the connector endface inspection sequence, transforming this critical process into one quick and easy step, which can be performed by technicians of all skill levels.

100%  
Automated<sup>a</sup>

1-step  
process<sup>a</sup>

57%  
shorter test time<sup>b</sup>

#### 3 models to fit your budget:

FEATURES	Basic FIP-410B	Semi-Automated FIP-420B	Fully-Automated FIP-430B
Three magnification levels	✓	✓	✓
Image capture	✓	✓	✓
Five-megapixel CMOS capturing device	✓	✓	✓
Automatic fiber image-centering function	✗	✓	✓
Automatic focus function	✗	✗	✓
On-board pass/fail analysis	✗	✓	✓
Pass/fail LED indicator	✗	✓	✓



Read the FIP-400B specification sheet or visit [www.EXFO.com/keepthefocus](http://www.EXFO.com/keepthefocus) for more information.

#### Notes

a. Model FIP-430B only.

b. Data sourced from EXFO's case study, with calculation based on typical analysis time.

## REMOVING THE COMPLEXITY FROM THE OTDR

### iOLM | intelligent Optical Link Mapper

Launch multiple OTDR acquisitions



Analyze the traces



Compound the results



Display a schematic link view and prompt diagnosis



US patent 6,612,750

Using a unique and patented automated multipulse and multi-wavelength acquisition approach, the field-proven iOLM surpasses the traditional OTDR and linear view for expert-level link characterization of any fiber network.

This dynamic OTDR-based application uses EXFO's most advanced algorithms to deliver detailed information and maximum resolution on every element of the link. Thanks to its unmatched intelligence and simplicity, the iOLM converts complex OTDR tests into clear and accurate go/no-go results, through a single button operation.

- › Hardware optimized and intelligent software for maximum performance
- › Multiple acquisitions, multiple wavelengths with one button—all automated
- › Expert-level characterization results in a single, comprehensive report
- › The fastest and hassle-free way to perform full fiber characterization
- › No training required: self-setting device with clear go/no-go results
- › Minimized truck rolls, thanks to the smartest analysis, powered by Link-Aware™ technology

Powered by  
**LINK AWARE™**  
TECHNOLOGY

### Three ways to benefit from the iOLM:

#### OTDR combo (Oi code)

Run iOLM and OTDR applications on one unit

#### Upgrade

Add iOLM software option, even while in the field

#### iOLM only

Order a unit with the iOLM application only

## TROUBLESHOOTING OF HIGH-SPEED MULTIMODE NETWORKS WITH ENCIRCLED FLUX (PRELIMINARY)

**EF** READY



SPSB-EF-C30

Whether it's for an expanding enterprise-class business or a large-volume data center, new high-speed data networks built with multimode fibers are running under tighter tolerances than ever before. In case of failure, intelligent and accurate test tools are needed to quickly find and fix the fault.

Multimode fibers are the trickiest links to test because the test results are highly dependent on each device's output conditions. Troubleshooting with a different unit than the construction unit may mislead the technician or result in the inability to find the fault, creating longer network downtimes.

For multimode fibers, EXFO recommends using an external launch mode conditioner that is encircled flux (EF) compliant. The encircled flux standard (as recommended in TIA-568 via TIA-526-14-B and IEC 61280-4-1 Ed. 2.0) is a way of controlling the source launch conditions so that Tier-2 troubleshooting can be performed with maximum accuracy and consistency.

The use of an external EF-compliant device\* such as the SPSB-EF-C30 will ensure a fast and easy way to fix faulty networks.

\*For more detailed information about encircled flux compliance, please read the encircled flux test solution specification sheet.

## MULTISERVICE POWERFUL AND FAST

The FTB-700G Series is a fully integrated optical, SONET/SDH, OTN, Fibre Channel and Ethernet handheld tester. It offers a 7-inch touchscreen with unprecedented configuration simplicity via hybrid touchscreen/keypad navigation. Platform connectivity is abundant via 3G, Wi-Fi, Bluetooth, Gigabit Ethernet or USB ports, making it accessible in any environment.

### What you need for any SONET/SDH, OTN, Fibre Channel or Ethernet application

- › Installation, commissioning and maintenance of access and metro networks
- › Turn-up of SONET/SDH circuits
- › Performance assessment of Carrier Ethernet services
- › Validation of OTN networks and services
- › Installation, activation and maintenance of metro Ethernet networks
- › Deployment of active Ethernet (point-to-point) access services
- › Installation and activation of Fibre Channel networks
- › Testing and troubleshooting
- › In-service troubleshooting of live traffic
- › Performance monitoring of SONET/SDH and OTN circuits
- › Round-trip delay assessment of transport circuits
- › BER testing up to 11.3 Gbit/s
- › FTTA validation for CPRI from 1.2 Gbit/s to 9.8 Gbit/s via BER testing

### SONET/SDH, OTN, FIBRE CHANNEL AND ETHERNET AT UP TO 11.3 GBIT/S

The FTB-700G Series is the perfect solution for multiservice testing up to 11.3 Gbit/s.

- › RJ-45 port for electrical 10/100/1000M Ethernet
- › SFP ports for OTU1, OC-1/3/12/48 or STM-0/1/4/16, Fibre Channel 1x/2x/4x or 100/1000M Ethernet, as well as CPRI 1.2G to 6.1G and OBSAI 3.1G
- › One SFP port at 2.5 and 3.1 Gbits/s
- › SFP+ port for OC-192, STM-64, 10 GigE, Fibre Channel 8X/10X, OTU2, and 9.8 Gbit/s for CPRI
- › SONET/SDH and OTN BER testing with configurable threshold settings
- › Coupled, Decoupled and Through mode testing
- › Error and alarm insertion and monitoring
- › Overhead monitoring and manipulation
- › High-order and low-order mappings
- › Tandem connection monitoring (TCM)
- › Pointer manipulation, including pointer sequence testing as per Telcordia GR-253, ANSI T1.105-03 and ITU G.783
- › Performance monitoring as per G.821, G.826, G.828, G.829, M.2100, M.2101
- › Frequency analysis and offset generation
- › Automatic protection switching
- › Service-disruption time measurements
- › Round-trip delay measurements
- › External clock sync support
- › 10Base-T to 10 GigE testing
- › EtherSAM (ITU-T Y.1564) (bidirectional)
- › RFC 2544 (bidirectional)
- › Traffic generation and monitoring
- › Through mode
- › Dual-port testing
- › Intelligent autodiscovery
- › MPLS
- › VLANs, including E-VLAN, S-VLAN, C-VLAN
- › 1588 PTP and SyncE
- › TCP Throughput
- › Full line-rate packet capture and advanced filtering from 10M to 10G
- › Carrier Ethernet OAM (MEF, 802.1ag, Y.1731 and G.8813.1 MPLS-TP)
- › IPv6 testing
- › Ping/Traceroute
- › Cable testing
- › Dual Test Set mode
- › Smart loopback
- › Fibre Channel 1x, 2x, 4x, 8x, 10x
- › FTTA BER testing up to 9.8 Gbit/s



## REVAMPED SETUP PROCEDURES

The new Test Configurator not only allows tests to be easily setup, it provides critical test info immediately after the actual setup stage. In the screenshot to the right, the RFC 2544 test was selected with Throughput and Back-To-Back tests enabled (Frame Loss and Latency are disabled). The green arrow pointing up confirms that the link is up. The destination IP address is resolved and the test is ready to be executed. The Test Configurator covers all stages of testing: setup, review and execution.

The control panel has icons to access the most important testing elements, buttons for the Setup, Results and Functions screens, as well as a clear pass/fail indicator. Field techs have the assurance that their testing time is optimized.

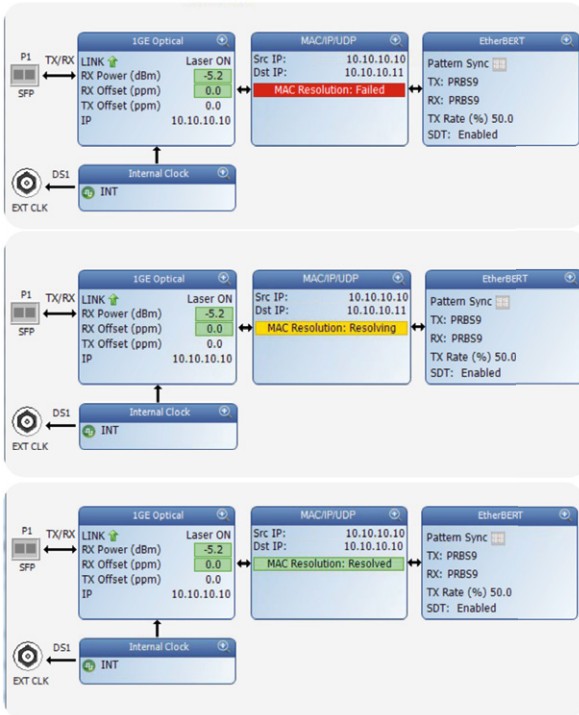

## MULTISERVICE

### Setting a New GUI Standard: Unprecedented Simplicity in Configuration Setup and Navigation

The FTB-700G Series intelligent situational-configuration setup feature guides technicians through complete, accurate testing processes (suggestion prompts, help guides, etc.). It reduces navigation by combining associated testing functions on a single screen, and offers intelligent autodiscovery that allows a single technician to perform end-to-end testing.

#### Dedicated Quick-Action Buttons

- › Remote discovery to find all other EXFO units
- › Laser on/off
- › Test reset to clear results and statistics while running a test
- › Report generation
- › Save or load test configurations
- › Quick error injection
- › Enable second Ethernet loopback port

#### Assorted Notifications

- › Clear indication of link status for single or dual ports
- › Negotiated speed display for single or dual ports

- › Power status available at all times for single or dual ports
- › Pass/fail indication at all times
- › Pattern and clock synchronization
- › Frequency offset with valid-range color indicator
- › Overhead overwrite indicator
- › Error/alarm injection
- › Alarm hierarchy pinpointing the root cause (when possible)

#### Streamlined Navigation

- › Remote discovery button available at all times; no reason to leave your current location to scan for a remote unit
- › Testing status can be maximized to fill the entire screen by simply clicking on the alarm status

button; whether the unit is in your hand or across the room, test results can be easily determined with a simple glance at the display screen

› RFC 2544 results and graphs are also maximized in a single page; no need to navigate through multiple screens to view individual RFC subtest results

› Simplified test structure definition using task-based test-application selection, signal configuration, front-end and smart timeslot selection

› Centralized functions: error/ alarm management, performance monitoring and overhead manipulation/monitoring



# MULTISERVICE

## Key Ethernet Features

### Intelligent Network Discovery Mode

Using the FTB-700G Series test set, you can single-handedly scan the network and connect to any available EXFO datacom remote tester. Simply select the unit to be tested and choose whether you want traffic to be looped back via Smart Loopback or Dual Test Set for simultaneous bidirectional EtherSAM and RFC 2544 results. No more need for an additional technician at the far end to relay critical information—these modules take care of it all.

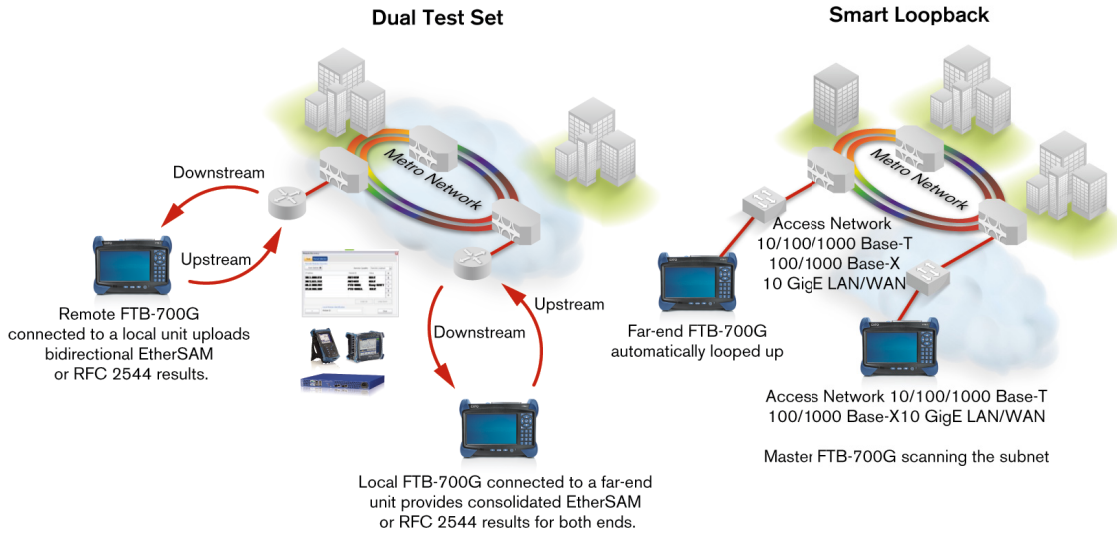

### Smart Loopback Flexibility

The Smart Loopback functionality has been enhanced to offer five distinct loopback modes. Whether you are looking to pinpoint loopback traffic from a UDP or TCP layer, or all the way down to a completely promiscuous mode (Transparent Loopback mode), the FTB-700G Series has the flexibility to adjust for all unique loopback situations.

### Dual-Port and Through Mode Testing

The NetBlazer series is equipped for both Through mode or dual-port testing. Through mode allows traffic to pass through either of the module's two electrical or optical ports for in-service troubleshooting of live traffic between the carrier/service provider network and the customer's network. This allows technicians to access circuits under test without the need for a splitter. With dual-port testing, the technician can use a single module to launch the test and perform the loopback. With two modules, the dual-port feature also enables users to run two simultaneous tests to maximize time and efficiency.

### VLAN/MPLS

Today's networks are expected to deliver high performance. To meet such high expectations, service providers must rely on various mechanisms, such as Ethernet tagging, encapsulation and labeling. Thanks to these additions, service providers can enhance security, scalability, reliability and performance. The FTB-700G Series module supports virtual local area network (VLAN) tags, Q-in-Q VLAN tags and multiprotocol label switching (MPLS).

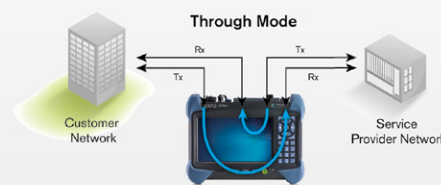

## MULTISERVICE

### ETHERSAM: THE NEW STANDARD IN ETHERNET TESTING

RFC 2544 used to be the most widespread Ethernet testing methodology. However, it was designed for network-device testing in the lab, not for service testing in the field. ITU-T Y.1564 is the new standard for turning up and troubleshooting Carrier Ethernet services. It has a number of advantages over RFC 2544, including validation of critical SLA criteria, such as packet jitter and QoS measurements. This methodology is also significantly faster, therefore saving time and resources while optimizing QoS.

EXFO's EtherSAM test suite—based on the ITU-T Y.1564 Ethernet service activation methodology—provides comprehensive field testing for mobile backhaul and commercial services.

Contrary to other methodologies, EtherSAM supports new multiservice offerings. It can simulate all types of services that will run on the network and simultaneously qualify all key SLA parameters for each of these services. Moreover, it validates the QoS mechanisms provisioned in the network to prioritize the different service types, resulting in better troubleshooting, more accurate validation and much faster deployment. EtherSAM is comprised of two phases, the service configuration test and the service performance test.

#### Service Configuration Test

The service configuration test consists of sequentially testing each service in order to validate that it is properly provisioned, and that all specific KPI or SLA parameters are met. A ramp test and a burst test are performed to verify the committed information rate (CIR), excess information rate (EIR), committed burst size (CBS) and excess burst size (EBS).

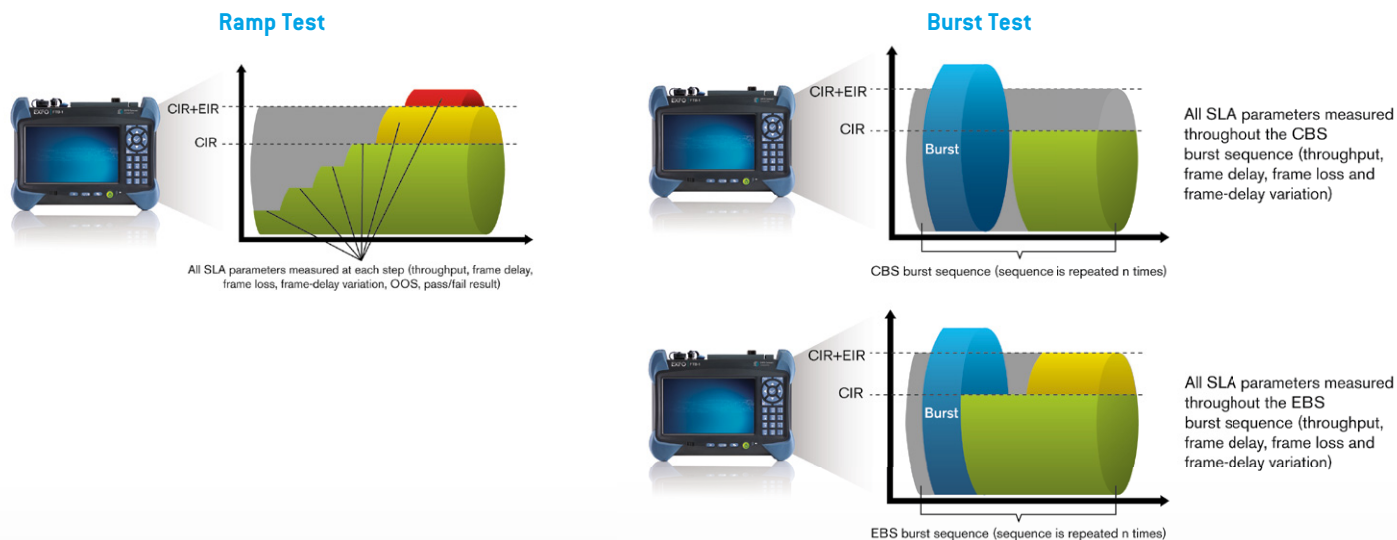

#### Service Performance Test

Once the configuration of each individual service is validated, the service performance test simultaneously validates the quality of all the services over time.

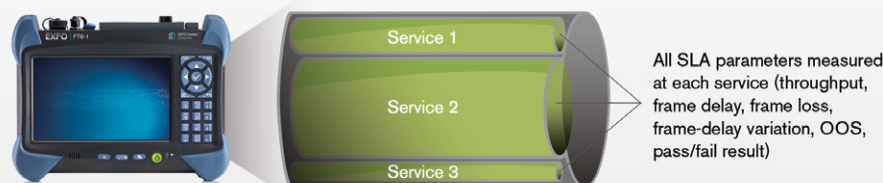



## MULTISERVICE

### EtherSAM Bidirectional Results

EXFO's EtherSAM approach proves even more powerful, as it executes the complete ITU-T Y.1564 test with bidirectional measurements. Key SLA parameters are measured independently in each test direction, thus providing 100% first-time-right service activation—the highest level of confidence in service testing.

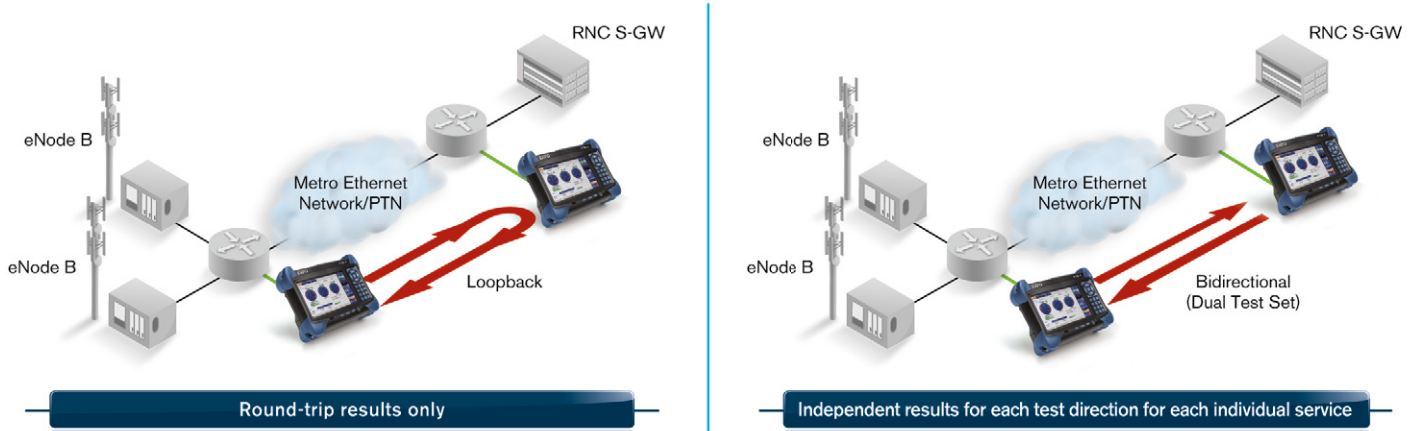

## FTTA TESTING

The times are constantly changing and the telecommunications industry is rapidly evolving to keep pace. This is especially true when it comes to mobile network operators (MNOs) and the delivery of their services. Bandwidth-hogging applications like high-definition video, media-rich content and interactive mobile applications are being introduced at an ever-increasing rate. The wireless infrastructure has to be modernized to keep up with this continuous, high-bandwidth growth and to minimize latency. To meet these expectations, MNOs are now switching their infrastructures from legacy "copper to the antenna" to fiber-to-the-antenna (FTTA). With the introduction of FTTA, MNOs can offer better performance with lower base-station costs. One key component of evolving to FTTA requires the addition of either the common public radio interface (CPRI) or the open base station architecture initiative (OBSAI).

Incorporating either CPRI or OBSAI, the actual base stations can be located in much less challenging locations, where size, climate and availability of power are much more easily managed. In addition, wireless network providers can maximize the base-station output by having multiple antennas per offsite base station.

With the FTB-700G Series of modules, field technicians can perform FTTA tests (CPRI or OBSAI). OBSAI testing is supported by 3.1 Gbit/s, and CPRI covers rates from 1.2 Gbit/s all the way up to 9.8 Gbit/s. The FTB-700G Series modules can perform a BER test that validates the fiber from the remote base station all the way to the remote radio head.

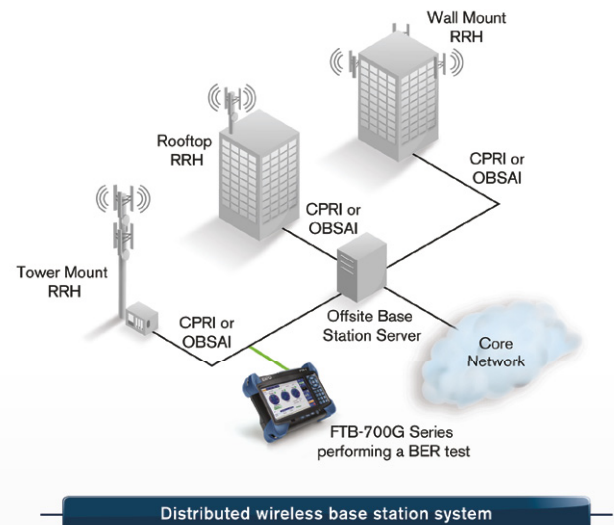

## Carrier Ethernet OAM

Ever since the introduction of metro Ethernet networks, there has been a need to ensure “five nines” level of availability, reliability and 50-millisecond recovery times from failures. Just as PDH, TDM and SONET/SDH, OAM has become a crucial network component that has enabled the same quality for carrier-class Ethernet.

The NetBlazer series offers a new application that validates the mechanics of the service operation, administration and maintenance (S-OAM) tools, which covers Y.1731, 802.1ag, G.8113.1 (MPLS-TP) and MEF modes. The features of this application include continuity check generation and monitoring, loopback testing, frame loss, synthetic loss and frame delay. There is also an S-OAM link trace and responder.

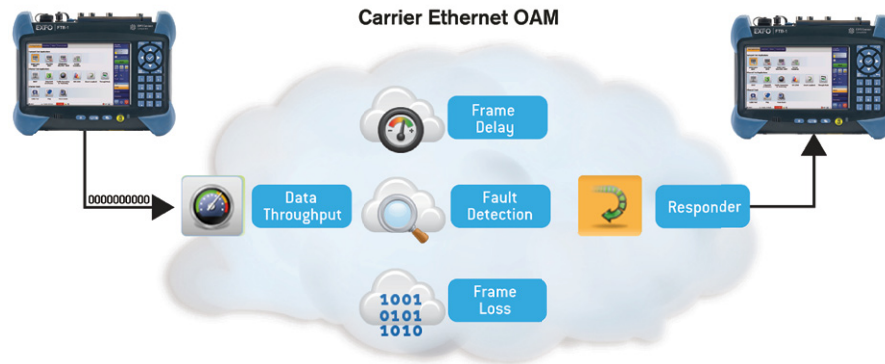

## Packet Capture

The capturing power of EXFO's NetBlazer Series extends far beyond basic capabilities. The NetBlazer series adds extra features and functionalities to boost test cycle efficiency and provides more value. Its packet capture tool offers comprehensive filtering, triggering and truncation methods to target specific traffic and quickly pinpoint issues in the lab and in the field.

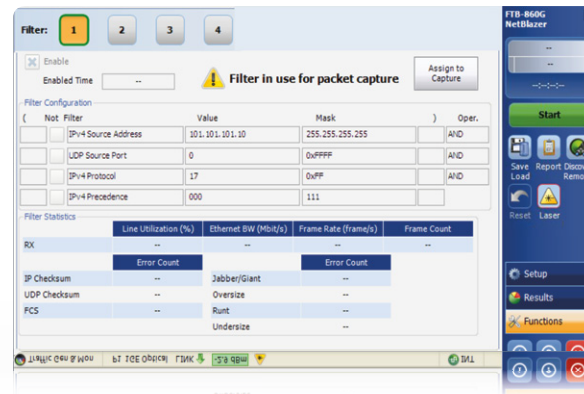

## Advanced Traffic Filtering

In some cases, troubleshooting only concerns a particular traffic flow. The advanced traffic-filtering capability of the NetBlazer series allows you to restrict traffic by using up to four matching fields and operands (and, or, not). A complete set of triggers is available, such as MAC, IP and TCP/UDP fields, as well as VLAN, MPLS fields.

## Traffic Generation and Monitoring

The NetBlazer series surpasses the multistream offerings of typical handheld Ethernet testing devices. 16 streams of traffic can be configured by a technician to test just about any frame format: Ethernet II, 802.3 SNAP, IPv4, IPv6, 3 levels of VLANs, MPLS, UDP and TCP. Each stream has an analog visual gauge and user-definable pass/fail thresholds that instantly show whether the test traffic is in or out of the expected ranges of the service level agreement.

## Layer 2 Transparency Testing

The NetBlazer uses a new virtual frame display that allows field techs to easily configure multiple streams and their parameters, including the ability to modify the source MAC address, Ethertype, etc. This makes it possible to test layer-2 protocols such as CDP, VTP and LLDP.

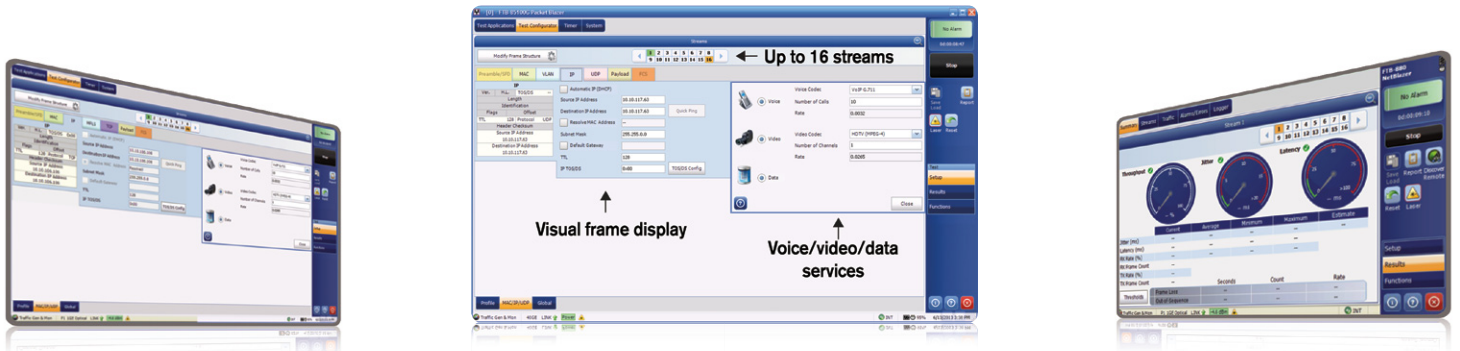

## EXacTCP

The transmission control protocol (TCP) ensures that data packets are reliably transmitted by the host to the destination. Applications such as hypertext transfer protocol (HTTP), e-mail or file transfer protocol (FTP) rely on TCP as their delivery mechanism. Those deploying such applications expect not only physical- and link-level SLAs from their service providers, but assurance that their TCP traffic requirements will be supported across the network. EXacTCP, the TCP throughput feature available in the NetBlazer series, is based on RFC 6349. It provides accurate measurements of TCP metrics, such as throughput, round-trip time (RTT) and optimal window size.

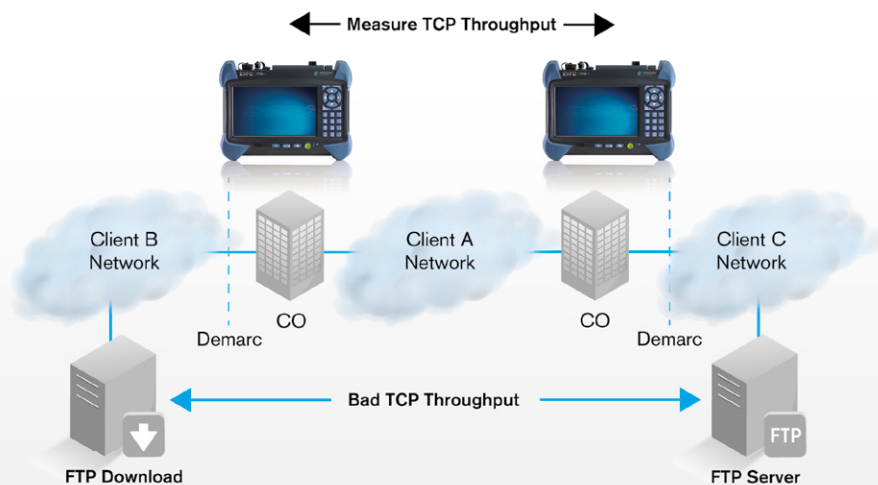

## MULTISERVICE EFFICIENTLY ASSESSING PERFORMANCE OF FIBRE CHANNEL SERVICES

The FTB-700G Series modules provide comprehensive testing capabilities for Fibre Channel network deployments, supporting multiple Fibre Channel interfaces.

### APPLICATIONS

Since most storage area networks (SANs) cover large distances and because Fibre Channel has stringent performance requirements, it is imperative to test at each phase of network deployment to ensure appropriate service levels. EXFO's FTB-700G Series modules provide full wire-speed traffic generation at the FC-2 layer, which allows BER testing for link integrity measurements. The FTB-700G Series also supports latency, buffer-to-buffer credit measurements for optimization, as well as login capabilities.

#### Latency

Transmission of frames in a network is not instantaneous, and is subject to multiple delays caused by the propagation delay in the fiber and by the processing time inside each piece of network equipment. Latency is the total accumulation of delays between two end-points. Some applications, such as VoIP, video, and storage area networks, are very sensitive to excess latency.

It is therefore critical for service providers to properly characterize network latency when offering Fibre Channel services. The FTB-700G Series modules estimate buffer-to-buffer credit value requirements from the performed latency measurement.

#### Buffer-to-Buffer Credit Estimation

To regulate traffic flow and congestion, Fibre Channel ports use "buffers" to temporarily store frames. The number of frames a port can store is referred to as a "buffer credit." Each time a frame is received by a port, an acknowledgement frame is sent. The buffer-to-buffer credit threshold refers to the amount of frames a port can transmit without receiving a single acknowledgement.

This is a crucial configuration parameter for optimal network performance. Usually, network administrators calculate the value by taking the traveled distance and the data rate into consideration; however, since latency issues are not considered, poor accuracy is to be expected. The FTB-700G Series modules are capable of estimating buffer credit values with respect to latency by calculating the distance according to the round-trip latency time. This value can then be used by network administrators to optimize the network configuration.

#### Login Testing

Most new-generation transport devices (xWDM or SONET/SDH mux) supporting Fibre Channel are no longer fully transparent; they also have increased built-in intelligence, acting more as Fibre Channel switches. With switch fabric login ability, the FTB-700G Series modules support connections to a remote location through a fabric or semitransparent network.

The login process not only permits the unit to connect through a fabric, but it also exchanges some of the basic port characteristics (such as buffer-to-buffer credit and class of service) in order to efficiently transport the traffic through the network.

The login feature allows automatic detection of port/fabric login, login status (successful login, in progress, failure and logout) and response to remote buffer-to-buffer advertised credit.

### COMPLETE SUITE OF FIBRE CHANNEL INTERFACES

Interface	Signal Rate (Gbit/s)	Data Rate (MB/s)
1x	1.0	100
2x	2.1	200
4x	4.2	400
8x	8.5	800
10x	10.5	1200

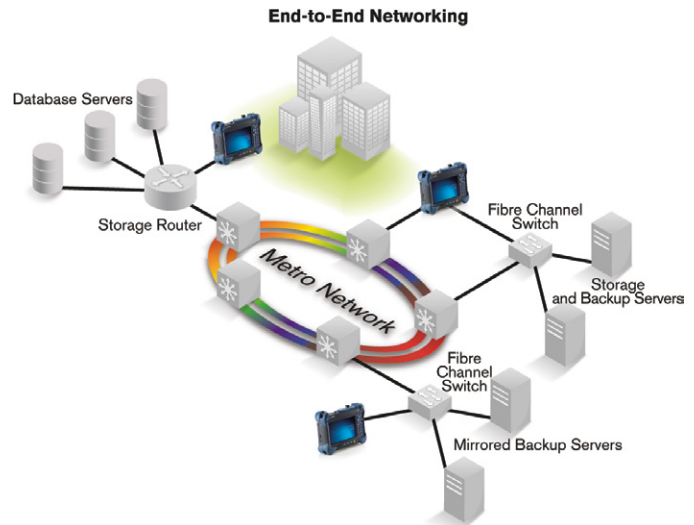

*Thanks to end-to-end network testing capabilities, EXFO's FTB-700G Series enables fast deployment and configuration of Fibre Channel networks. Communication between the transport network, interconnection devices and end nodes can be validated with features such as BER testing, latency measurement, buffer-to-buffer credit estimation and port login capabilities.*



## MULTISERVICE

## EXFO Connect

## EXFO | Connect

**AUTOMATED ASSET MANAGEMENT. PUSH TEST DATA IN THE CLOUD. GET CONNECTED.**

EXFO Connect pushes and stores test equipment and test data content automatically in the cloud, allowing you to streamline test operation from build-out to maintenance.

## EXPERT TEST TOOLS ON THE FTB-1 PLATFORM

EXpert Test Tools is a series of platform-based software testing tools that enhance the value of the FTB-1 platform, providing additional testing capabilities without the need for additional modules or units.

## EXpert TEST TOOLS

## EXpert VoIP TEST TOOLS

The EXpert VoIP Tools generate a voice-over-IP call directly from the test platform to validate performance during service turn-up and troubleshooting.

- Supports a wide range of signaling protocols, including SIP, SCCP, H.248/Megaco and H.323
- Supports MOS and R-factor quality metrics
- Simplifies testing with configurable pass/fail thresholds and RTP metrics

## EXpert IP TEST TOOLS

The EXpert IP Tools integrate six commonly used datacom test tools into one platform-based application to ensure that field technicians are prepared for a wide range of testing needs.

- Rapidly perform debugging sequences with VLAN scan and LAN discovery
- Validate end-to-end ping and traceroute
- Verify FTP performance and HTTP availability

## EXpert IPTV TEST TOOLS

This powerful IPTV quality assessment solution enables set-top-box emulation and passive monitoring of IPTV streams, allowing quick and easy pass/fail verification of IPTV installations.

- Real-time video preview
- Analyzes up to 10 video streams
- Comprehensive QoS and QoE metrics, including MOS score



OPTICAL TECHNICAL SPECIFICATIONS <sup>a</sup>

TECHNICAL SPECIFICATIONS	FTB-720G	FTB-730G OTDR
Wavelength (nm) <sup>b</sup>	850 ± 20, 1300 ± 20, 1310 ± 20, 1550 ± 20	1310 ± 20/1550 ± 20
Dynamic range (dB) <sup>c-d</sup>	27, 26, 36	39/37
Event dead zone (m) <sup>e</sup>	0.8	0.8
Attenuation dead zone (m) <sup>e</sup>	4, 4.5, 5, 5, 5	4/4.5
Distance range (km)	Multimode: 0.1, 0.3, 0.5, 1.3, 2.5, 5, 10, 20, 40 Singlemode: 1.25, 2.5, 5, 10, 20, 40, 80, 160, 260	1.25, 2.5, 5, 10, 20, 40, 80, 160, 260, 400
Pulse width (ns)	Multimode: 5, 10, 30, 50, 100, 275, 500, 1000 Singlemode: 5, 10, 30, 50, 100, 275, 500, 1000, 2500, 10 000, 20 000	5, 10, 30, 50, 100, 275, 500, 1000, 2500, 10 000, 20 000
Launch conditions <sup>f</sup>	Encircled Flux (EF) compliant <sup>i</sup>	
Linearity (dB/dB) <sup>b</sup>	±0.03	±0.03
Loss threshold (dB)	0.01	0.01
Loss resolution (dB)	0.001	0.001
Sampling resolution (m)	Multimode: 0.04 to 2.5 Singlemode: 0.04 to 5	0.04 to 5
Sampling points	Up to 256 000	Up to 256 000
Distance uncertainty (m) <sup>g</sup>	±(0.75 + 0.0025 % x distance + sampling resolution)	±(0.75 + 0.0025 % x distance + sampling resolution)
Measurement time	User-defined (60 min. maximum)	User-defined (60 min. maximum)
Typical real-time refresh (Hz)	3	4
Stable source output power (dBm) <sup>h</sup>	-3 (1300 nm), -7 (1550 nm)	-2.5
Reflectance		±2

**Notes**

- All specifications valid at 23 °C ± 2 °C with an FC/PC connector, unless otherwise specified; APC connector for FTB-720G and FTB-730G singlemode models.
- Typical.
- Typical dynamic range with longest pulse and three-minute averaging at SNR = 1.
- Typical dead zone for reflectance below -45 dB, using a 5 ns pulse.
- Does not include uncertainty due to fiber index.
- Typical output power is given at 1550 nm.
- Non-reflective FUT, non-reflective splitter, 13 dB loss, 50 ns pulse, typical value.

## MULTISERVICE SPECIFICATIONS

SFP ETHERNET OPTICAL INTERFACES							
	Two ports: 100M and GigE						
Available wavelengths (nm)	850, 1310 and 1550						
Model	FTB-85910	FTB-85911	FTB-8590	FTB-8190	FTB-8192	FTB-8596	FTB-8597
Transceiver type	<b>100 Base-FX</b>	<b>100 Base-LX</b>	<b>1000 Base-SX</b>	<b>1000 Base-LX</b>	<b>1000 Base-ZX</b>	<b>1000 Base-BX10-D</b>	<b>1000 Base-BX10-U</b>
Wavelength (nm)	1310	1310	850	1310	1550	Tx: 1490 Rx: 1310	Tx: 1310 Rx: 1490
Tx level (dBm)	-20 to -15	-15 to -8	-9 to -3	-9.5 to -3	0 to 5	-9.5 to -3	-9.5 to -3
Rx level sensitivity (dBm)	-31	-28	-20	-22	-22	-20	-20
Maximum reach	2 km	15 km	550 m	10 km	80 km	10 km	10 km
Transmission bit rate (Gbit/s)	0.125	0.125	1.25	1.25	1.25	1.25	1.25
Reception bit rate (Gbit/s)	0.125	0.125	1.25	1.25	1.25	1.25	1.25
Tx operational wavelength range (nm)	1280 to 1380	1261 to 1360	830 to 860	1270 to 1360	1540 to 1570	1480 to 1500	1260 to 1360
Measurement accuracy (uncertainty)							
Frequency (ppm)	±4.6	±4.6	±4.6	±4.6	±4.6	±4.6	±4.6
Optical power (dB)	±2	±2	±2	±2	±2	±2	±2
Maximum Rx before damage (dBm) <sup>a</sup>	3	3	6	6	6	6	6
Jitter compliance	ANSI x3.166	IEEE 802.3	IEEE 802.3	IEEE 802.3		IEEE 802.3ah	IEEE 802.3ah
Ethernet classification	ANSI x3.166	IEEE 802.3	IEEE 802.3	IEEE 802.3		IEEE 802.3ah	IEEE 802.3ah
Laser type	LED	FP	VCSEL	FP	DFB	DFB	FP
Laser product	Class 1	Class 1	Class 1	Class 1	Class 1	Class 1	Class 1
Connector <sup>b</sup>	LC	LC	LC	LC	LC	LC	LC

SFP <sup>c</sup> SONET/SDH AND OTN OPTICAL INTERFACES												
Transceiver type	OC-3/STM-1				OC-12/STM-4				OC-48/STM-16/OTU1			
Reach and wavelength	15 km; 1310 nm	40 km; 1310 nm	40 km; 1550 nm	80 km; 1550 nm	15 km; 1310 nm	40 km; 1310 nm	40 km; 1550 nm	80 km; 1550 nm	15 km; 1310 nm	40 km; 1310 nm	40 km; 1550 nm	80 km; 1550 nm
Model	FTB-8190	FTB-8191	FTB-8193	FTB-8192	FTB-8190	FTB-8191	FTB-8193	FTB-8192	FTB-8190	FTB-8191	FTB-8193	FTB-8192
Tx level (dBm)	-5 to 0	-2 to 3	-5 to 0	-2 to 3	-5 to 0	-2 to 3	-5 to 0	-2 to 3	-5 to 0	-2 to 3	-5 to 0	-2 to 3
Rx operating range (dBm)	-23 to -10	-30 to -15	-23 to -10	-30 to -15	-22 to 0	-27 to -9	-22 to 0	-29 to -9	-18 to 0	-27 to -9	-18 to 0	-28 to -9
Transmit bit rate	155.52 Mbit/s ± 4.6 ppm				622.08 Mbit/s ± 4.6 ppm				2.48832 Gbit/s ± 4.6 ppm 2.66606 Gbit/s ± 4.6 ppm			
Frequency offset generation (ppm)	±50				±50				±50			
Receive bit rate	155.52 Mbit/s ± 100 ppm				622.08 Mbit/s ± 100 ppm				2.48832 Gbit/s ± 100 ppm 2.66606 Gbit/s ± 100 ppm (OTU1)			
Operational wavelength range (nm)	1261 to 1360	1263 to 1360	1430 to 1580	1480 to 1580	1270 to 1360	1280 to 1335	1430 to 1580	1480 to 1580	1260 to 1360	1280 to 1335	1430 to 1580	1500 to 1580
Spectral width	1 nm (-20 dB)				1 nm (-20 dB)				1 nm (-20 dB)			
Measurement accuracy (uncertainty)												
Frequency (ppm)	±4.6				±4.6				±4.6			
Optical power (dB)	±2				±2				±2			
Maximum Rx before damage (dBm) <sup>a</sup>	3				3				3			
Jitter compliance	GR-253 (SONET) G.958 (SDH)				GR-253 (SONET) G.958 (SDH)				GR-253 (SONET) G.958 (SDH) G.8251 (OTN)			
Line coding	NRZ				NRZ				NRZ			
Laser product	Class 1				Class 1				Class 1			
Connector <sup>b</sup>	LC				LC				LC			

## Notes

- To avoid exceeding the maximum receiver power level before damage, an attenuator must be used.
- External adaptors can be used for other types of connectors.
- SFP compliance: The FTB-700G Series selected SFP shall meet the requirements stated in the "Small Form-Factor Pluggable (SFP) Transceiver Multisource Agreement (MSA)." The FTB-700G Series selected SFP shall meet the requirements stated in the "Specification for Diagnostic Monitoring Interface for Optical Xcvrs."

SFP+ ETHERNET OPTICAL INTERFACES			
Transceiver type	10G Base-SR/SW	10G Base-LR/LW	10G Base-ER/EW
Wavelength (nm)	850	1310	1550
Model	FTB-8690	FTB-8691	FTB-8692
Tx level (dBm)	-5 to -1	-8 to 0.5	-4.7 to 4.0
Rx level sensitivity (dBm)	-11.1	-12.6	-14.1
Maximum reach	300 m	10 km	40 km
Tx bit rate (Gbit/s)	9.95 to 10.3	9.95 to 10.3	9.95 to 10.3
Rx bit rate (Gbit/s)	9.95 to 10.3	9.95 to 10.3	9.95 to 10.3
Tx operational wavelength range (nm)	840 to 860	1260 to 1355	1530 to 1565
Measurement accuracy (uncertainty) Frequency (ppm)	±4.6	±4.6	±4.6
Maximum Rx before damage (dBm) <sup>a</sup>	6	5	5
Jitter compliance	IEEE 802.3ae	IEEE 802.3ae	IEEE 802.3ae
Laser type	VCSEL	DFB	CML
Laser product	Class 1	Class 1	Class 1
Connector <sup>b</sup>	LC	LC	LC

SFP+ <sup>c</sup> 10G SONET/SDH AND OTN OPTICAL INTERFACES			
Transceiver type	OC-192/STM-64/OTU2	OC-192/STM-64/OTU2	OC-192/STM-64/OTU2
Wavelength (nm)	1310	1550	1550
Model	FTB-8693	FTB-8694	FTB-8695
Tx level (dBm)	-6 to -1	-1 to 2	0 to 4
Rx level sensitivity (dBm)	-11 to 0.5	-14 to -1	-24 to -7
Maximum reach	10 km	40 km	80 km
Transmission bit rate (Gbit/s)	9.9532 ± 4.6 ppm 10.7092 ± 4.6 ppm (OTU2) 11.0491 ± 4.6 ppm (OTU1e) 11.0957 ± 4.6 ppm (OTU2e) 11.2701 ± 4.6 ppm (OTU1f) 11.3176 ± 4.6 ppm (OTU2f)	9.9532 ± 4.6 ppm 10.7092 ± 4.6 ppm (OTU2) 11.0491 ± 4.6 ppm (OTU1e) 11.0957 ± 4.6 ppm (OTU2e) 11.2701 ± 4.6 ppm (OTU1f) 11.3176 ± 4.6 ppm (OTU2f)	9.9532 ± 4.6 ppm 10.7092 ± 4.6 ppm (OTU2) 11.0491 ± 4.6 ppm (OTU1e) 11.0957 ± 4.6 ppm (OTU2e) 11.2701 ± 4.6 ppm (OTU1f) 11.3176 ± 4.6 ppm (OTU2f)
Frequency offset generation (ppm)	±50	±50	±50
Reception bit rate (Gbit/s)	9.9532 ± 100 ppm 10.7092 ± 100 ppm (OTU2) 11.0491 ± 120 ppm (OTU1e) 11.0957 ± 120 ppm (OTU2e) 11.2701 ± 120 ppm (OTU1f) 11.3176 ± 120 ppm (OTU2f)	9.9532 ± 100 ppm 10.7092 ± 100 ppm (OTU2) 11.0491 ± 120 ppm (OTU1e) 11.0957 ± 120 ppm (OTU2e) 11.2701 ± 120 ppm (OTU1f) 11.3176 ± 120 ppm (OTU2f)	9.9532 ± 100 ppm 10.7092 ± 100 ppm (OTU2) 11.0491 ± 120 ppm (OTU1e) 11.0957 ± 120 ppm (OTU2e) 11.2701 ± 120 ppm (OTU1f) 11.3176 ± 120 ppm (OTU2f)
Tx operational wavelength range (nm)	1260 to 1355	1530 to 1565	1530 to 1565
Measurement accuracy (uncertainty) Frequency (ppm) Optical power (dB)	±4.6 ±2	±4.6 ±2	±4.6 ±2
Maximum Rx before damage (dBm) <sup>a</sup>	5	5	3
Jitter compliance	GR-253 (SONET) G.825 (SDH) G.8251 (OTN)	GR-253 (SONET) G.825 (SDH) G.8251 (OTN)	GR-253 (SONET) G.825 (SDH) G.8251 (OTN)
Laser product	Class 1	Class 1	Class 1
Connector <sup>b</sup>	LC	LC	LC

**Notes**

- To avoid exceeding the maximum receiver power level before damage, an attenuator must be used.
- External adaptors can be used for other types of connectors.
- SFP+ compliance: The FTB-700G Series selected SFP+ shall meet the requirements stated in the SFP-8431 "Enhanced Small Form-Factor Pluggable Module SFP+" Transceiver Multisource Agreement (MSA).<sup>®</sup> The FTB-700G Series selected SFP+ shall meet the requirements stated in the "Specification for Diagnostic Monitoring Interface for Optical Xcvrs."



## ELECTRICAL ETHERNET INTERFACES

	Two ports: 10/100Base-T half/full duplex, 1000Base-T full duplex Automatic or manual detection of straight/crossover cable		
	10Base-T	100Base-TX	1000Base-T
Transceiver type			
Tx bit rate	10 Mbit/s	125 Mbit/s	1 Gbit/s
Tx accuracy (uncertainty) (ppm)	±4.6	±4.6	±4.6
Rx bit rate	10 Mbit/s	125 Mbit/s	1 Gbit/s
Rx measurement accuracy (uncertainty) (ppm)		±4.6	±4.6
Duplex mode	Half and full duplex	Half and full duplex	Full duplex
Jitter compliance	IEEE 802.3	IEEE 802.3	IEEE 802.3
Connector	RJ-45	RJ-45	RJ-45
Maximum reach (m)	100	100	100

## SFP FIBRE CHANNEL INTERFACES

## FC-1x/2x/4x

	850	1310	1310	1550
Wavelength (nm)	850	1310	1310	1550
Model	FTB-85912	FTB-85913	FTB-85914	FTB-85915
Tx level (dBm)	-9 to -2.5	-8.4 to -3	0 to 5	1 to 5
Rx level sensitivity (dBm)	-15 at FC-4 -18 at FC-2 -20 at FC-1	-18 at FC-4 -21 at FC-2 -22 at FC-1	-18 at FC-4 -21 at FC-2 -22 at FC-1	-16.5 at FC-4 -20.5 at FC-2 -22 at FC-1
Maximum reach (FC-1)	500 m on 50/125 µm MMF 300 m on 62.5/125 µm MMF	4 km	30 km	40 km
Transmission bit rate (Gbit/s)	1.06/2.125/4.25	1.06/2.125/4.25	1.06/2.125/4.25	1.06/2.125/4.25
Reception bit rate (Gbit/s)	1.06/2.125/4.25	1.06/2.125/4.25	1.06/2.125/4.25	1.06/2.125/4.25
Tx operational wavelength range (nm)	830 to 860	1260 to 1350	1285 to 1345	1544.5 to 1557.5
Measurement accuracy (uncertainty)				
Frequency (ppm)	±4.6	±4.6	±4.6	±4.6
Optical power (dB)	±2	±2	±2	±2
Max Rx before damage (dBm)	3	3	3	3
Jitter compliance	ANSI FC-PI-2	ANSI FC-PI-2	ANSI FC-PI-2	ANSI FC-PI-2
FC classification	ANSI FC-PI-2	ANSI FC-PI-2	ANSI FC-PI-2	ANSI FC-PI-2
Laser type	VCSEL	Fabry-Perot	DFB	DFB
Laser product	Class 1	Class 1	Class 1	Class 1
Connector	LC	LC	LC	LC

## SFP+ FIBRE CHANNEL INTERFACES

## FC-8x/10x

	850	850	1310	1550	1550
Wavelength (nm)	850	850	1310	1550	1550
Model	FTB-8696	FTB-8690	FTB-8693	FTB-8694	FTB-8695
Tx level (dBm)	-8.2 to -2	-5 to -1	-6 to -1	-1 to 2	0 to 4
Rx level sensitivity (dBm)	-11.1 to 0	-11.1 to 0.5	-14.4 to 0.5	-14 to -1	-24 to -7
Maximum reach	150 m on OM3 MMF	300 m on OM3 MMF	10 km	40 km	80 km
Transmission bit rate (Gbit/s)	8.5	10.5	8.5/10.5	8.5/10.5	8.5/10.5
Reception bit rate (Gbit/s)	8.5	10.5	8.5/10.5	8.5/10.5	8.5/10.5
Tx operational wavelength range (nm)	840 to 860	840 to 860	1260 to 1355	1530 to 1565	1530 to 1565
Measurement accuracy (uncertainty)					
Frequency (ppm)	±4.6	±4.6	±4.6	±4.6	±4.6
Optical power (dB)	±2	±2	±2	±2	±2
Max Rx before damage (dBm)	+5	+5	+5	+5	+3
Jitter compliance	ANSI FC-PI-3	ANSI FC-PI-3	ANSI FC-PI-3	ANSI FC-PI-3	ANSI FC-PI-3
FC classification	ANSI FC-PI-3	ANSI FC-PI-3	ANSI FC-PI-3	ANSI FC-PI-3	ANSI FC-PI-3
Laser type	VCSEL	VCSEL	DFB	CML	EML
Laser product	Class 1	Class 1	Class 1	Class 1	Class 1
Connector	LC	LC	LC	LC	LC

## SFP/SFP+ FTTA INTERFACES

## CPRI/OBSAI

Wavelength (nm)	850	1310	1310	1310	1550
EXFO product number	FTB-8590	FTB-8190	FTB-8191	SFP-8600	FTB-8192
Tx level (dBm)	-9 to -3	-5 to 0	-2 to 3	-8.2 to 0.5	-2 to 3
Rx level sensitivity (dBm)	-18 to 0	-18 to 0	-27 to -9	0.5 (max)	-28 to -9
Maximum reach	300 m on OM3 MMF	15 km	40 km	1.4 km (SMF)	80 km
Transmission bit rate (Gbit/s)	2.4576/3.072	2.4576/3.072	2.4576/3.072	1.2288-9.8304	2.4576/3.072
Reception bit rate (Gbit/s)	2.4576/3.072	2.4576/3.072	2.4576/3.072	1.2288-9.8304	2.4576/3.072
Tx operational wavelength range (nm)	830-860	1270-1360	1280 to 1355	1260 to 1355	1500 to 1580
Measurement accuracy (uncertainty) Optical power (dB)	±2	±2	±2	±2	±2
Max Rx before damage (dBm)	+5	+5	+3	+5	+3
Jitter compliance	IEEE 802.3	GR-253 (SONET) G-958 (SDH)	GR-253 (SONET) G-958 (SDH)	IEEE 802.3ae	GR-253 (SONET) G-958 (SDH)
Laser type	VCSEL	DFB	DFB	FP	CML
Eye safety	Class 1	Class 1	Class 1	Class 1	Class 1
Connector	LC	LC	LC	LC	LC
Transceiver type	SFP	SFP	SFP	SFP+	SFP

## SYNCHRONIZATION INTERFACES

	External Clock DS1/1.5M	External Clock E1/2M	External Clock E1/2M	Trigger 2 MHz
Tx pulse amplitude (V)	2.4 to 3.6	3.0	2.37	0.75 to 1.5
Tx pulse mask	GR-499 Figure 9.5	G.703 Figure 15	G.703 Figure 15	G.703 Figure 20
Tx LBO preamplification	Typical power dBdsx +0.6 dBdsx (0-133 ft) +1.2 dBdsx (133-266 ft) +1.8 dBdsx (266-399 ft) +2.4 dBdsx (399-533 ft) +3.0 dBdsx (533-655 ft)			
Rx level sensitivity	TERM: ≤6 dB (cable loss only) (at 772 kHz for T1) DSX-MON: ≤26 dB (20 dB resistive loss + cable loss ≤ 6 dB) Bridge: ≤6 dB (cable loss only)	TERM: ≤6 dB (cable loss only) MON: ≤26 dB (20 dB resistive loss + cable loss ≤ 6 dB) Bridge: ≤6 dB (cable loss only)	TERM: ≤6 dB (cable loss only) MON: ≤26 dB (resistive loss + cable loss ≤ 6 dB) Bridge: ≤6 dB (cable loss only)	≤6 dB (cable loss only)
Transmission bit rate	1.544 Mbit/s ± 4.6 ppm	2.048 Mbit/s ± 4.6 ppm	2.048 Mbit/s ± 4.6 ppm	
Reception bit rate	1.544 Mbit/s ± 50 ppm	2.048 Mbit/s ± 50 ppm	2.048 Mbit/s ± 50 ppm	
Intrinsic jitter (Tx)	ANSI T1.403 section 6.3 GR-499 section 7.3	G.823 section 6.1	G.823 section 6.1	G.703 table 11
Input jitter tolerance	AT&T PUB 62411 GR-499 section 7.3	G.823 section 7.2 G.813	G.823 section 7.2 G.813	G.823 section 7.1 G.751 section 3.3
Line coding	AMI and B8ZS	AMI and HDB3	AMI and HDB3	
Input impedance (resistive termination)	75 ohms ± 5 %, unbalanced	75 ohms ± 5 %, unbalanced	75 ohms ± 5 %, unbalanced	75 ohms ± 5 %, unbalanced
Connector type	BNC <sup>a</sup>	BNC <sup>a</sup>	BNC	BNC

## FIBRE CHANNEL FUNCTIONAL SPECIFICATIONS

## TESTING 1x, 2x, 4x, 8x, 10x

BERT	Framed FC-2
Patterns (BERT)	PRBS 2E31-1, 2E23-1, 2E20-1, 2E15-1, 2E11-1, 2E9-1, one user-defined pattern and capability to invert patterns
Error insertion	Bit error, amount and rate
Error measurement	Bit error, symbol error, oversize error, crc error, undersize error and block error (10x only)
Alarm detection	LOS, pattern loss, link down, local and remote fault (10x only)
Buffer-to-buffer credit testing	Buffer-to-buffer credit estimation based on latency
Latency	Round-trip latency

## Note

a. Adaptation cable required for BANTAM.

SONET FUNCTIONAL SPECIFICATIONS		SDH FUNCTIONAL SPECIFICATIONS	
Optical interfaces	OC-1, OC-3, OC-12, OC-48, OC-192	Optical interfaces	STM-0, STM-1, STM-4, STM-16, STM-64
Available wavelengths (nm)	1310, 1550	Available wavelengths (nm)	1310, 1550
Clocking	Internal, loop-timed, external (BITS)	Clocking	Internal, loop-timed, external (MTS/SETS), 2 MHz
<b>Mappings</b>			
VT1.5	Bulk	AU-3-TU-11, AU-4-TU-11	Bulk
VT2	Bulk	AU-3-TU-12, AU-4-TU-12	Bulk
STS-1 SPE	Bulk	AU-3, AU-4-TU-3	Bulk
STS-3c	Bulk	AU-4	Bulk
STS-12c/48c/192c, SPE	Bulk	AU-4-4c/16c/64c	Bulk
SONET overhead analysis and manipulation	A1, A2, J0, E1, F1, D1-D12, K1, K2, S1, M0, M1, E2, J1, C2, G1, F2, H4, Z3, Z4, Z5, N1, N2, Z6, Z7	SDH overhead analysis and manipulation	A1, A2, J0, E1, F1, D1-D12, K1, K2, S1, M0, M1, G1, F2, F3, K3, N1, N2, K4, E2, J1, C2, H4
<b>Error insertion</b>			
OC-1, OC-3, OC-12, OC-48, OC-192	Section BIP (B1), line BIP (B2), path BIP (B3), BIP-2, REI-L, REI-P, REI-V, FAS, bit error	STM-0, STM-1, STM-4, STM-16, STM-64	RS-BIP (B1), MS-BIP (B2), HP-BIP (B3), MS-REI, HP-REI, LP-BIP-2, LP-REI, FAS, bit error
<b>Error measurement</b>			
OC-1, OC-3, OC-12, OC-48, OC-192	Section BIP (B1), line BIP (B2), path BIP (B3), BIP-2, REI-L, REI-P, REI-V, FAS, bit error	STM-0, STM-1, STM-4, STM-16, STM-64	RS-BIP (B1), MS-BIP (B2), HP-BIP (B3), MS-REI, HP-REI, LP-BIP-2, LP-REI, FAS, bit error
<b>Alarm insertion</b>			
OC-1, OC-3, OC-12, OC-48, OC-192	LOS, LOF-S, SEF, AIS-L, RDH-L, AIS-P, LOP-P, LOM, PDI-P, RDI-P, ERDI-PCD, ERDI-PPD, ERDI-PSD, UNEQ-P, AIS-V, LOP-V, RDI-V, ERDI-VCD, ERDI-VPD, ERDI-VSD, RFI-V, UNEQ-V, pattern loss	STM-0, STM-1, STM-4, STM-16, STM-64	LOS, LOF, OOF, MS-AIS, MS-RDI, AU-AIS, AU-LOP, H4-LOM, HP-ERDI-CD, HP-ERDI-PD, HP-ERDI-SD, LP-ERDI-CD, LP-ERDI-PD, LP-ERDI-SD, HP-UNEQ, TU-AIS, LP-RFI, LP-RDI, LP-RFI, LP-UNEQ, pattern loss
<b>Alarm detection</b>			
OC-1, OC-3, OC-12, OC-48, OC-192	LOS, LOC, LOF-S, SEF, TIM-S, AIS-L, RDH-L, AIS-P, LOP-P, LOM, PDI-P, RDI-P, ERDI-PCD, ERDI-PPD, ERDI-PSD, PLM-P, UNEQ-P, TIM-P, AIS-V, LOP-V, RDI-V, ERDI-VCD, ERDI-VPD, ERDI-VSD, RFI-V, UNEQ-V, TIM-V, PLM-V, pattern loss	STM-0, STM-1, STM-4, STM-16, STM-64	LOS, RS-LOF, LOC, RS-OOF, RS-TIM, MS-AIS, MS-RDI, AU-AIS, AU-LOP, H4-LOM, HP-RDI, HP-ERDI-CD, HP-ERDI-PD, HP-ERDI-SD, LP-ERDI-CD, LP-ERDI-PD, LP-ERDI-SD, HP-PLM, HP-UNEQ, HP-TIM, TU-AIS, LP-RFI, LP-RDI, LP-RFI, LP-UNEQ, LP-TIM, LP-PLM, pattern loss
<i>Frequency alarm on all supported interfaces</i>			
<b>Patterns</b>			
VT1.5/2	2E9-1, 2E11-1, 2E15-1, 2E20-1, 2E23-1, 2E31-1, 1100, 1010, 1111, 0000, 1-in-8, 1-in-16, 32-bit programmable (inverted or non-inverted), bit errors	TU-11/12/3	2E9-1, 2E11-1, 2E15-1, 2E20-1, 2E23-1, 2E31-1, 1100, 1010, 1111, 0000, 1-in-8, 1-in-16, 32-bit programmable (inverted or non-inverted), bit errors
STS-1, STS-3c/12c/48c/192c	2E9-1, 2E11-1, 2E15-1, 2E20-1, 2E23-1, 2E31-1, 1100, 1010, 1111, 0000, 1-in-8, 1-in-16, 32-bit programmable (inverted or non-inverted), bit errors	AU-3/AU-4/AU-4-4c/16c/64c	2E9-1, 2E11-1, 2E15-1, 2E20-1, 2E23-1, 2E31-1, 1100, 1010, 1111, 0000, 1-in-8, 1-in-16, 32-bit programmable (inverted or non-inverted), bit errors
<i>Pattern loss and bit error generation and analysis supported on all patterns</i>			

SONET/SDH TEST FEATURES	
Frequency measurements	Supports clock frequency measurements (i.e., received frequency and deviation of the input signal clock from nominal frequency), displayed in ppm, for optical and electrical interfaces. Measurements are performed using a local oscillator.
Frequency offset generation	Supports offsetting the clock of the transmitted signal on a selected interface to exercise clock recovery circuitry on network elements.
Performance monitoring	The following ITU-T recommendations, and corresponding performance monitoring parameters, are supported on the FTB-700G Series. <b>ITU-T recommendation</b> G.821 G.828 G.829 M.2100 M.2101 <b>Performance monitoring statistics</b> ES, EFS, EC, SES, UAS, ESR, SESR, DM ES, EFS, EB, SES, BBE, SEP, UAS, ESR, SESR, BBER, SEPI ES, EFS, EB, SES, BBE, UAS, ESR, SESR, BBER ES, SES, UAS, ESR, SESR ES, SES, BBE, UAS, ESR, SESR, BBER
Pointer adjustment and analysis	Generation and analysis of STS/AU and VT/TU pointer adjustments as per GR-253, and ITU-T G.707 <b>Generation</b> <ul style="list-style-type: none"> <li>• Pointer increment and decrement</li> <li>• Pointer jump with or without NDF</li> <li>• Pointer value</li> </ul> <b>Analysis</b> <ul style="list-style-type: none"> <li>• Pointer increments and decrements</li> <li>• Pointer jumps with or without NDF</li> <li>• Pointer value and cumulative offset</li> </ul>
Pointer sequence testing	Perform pointer sequence testing as per G.783, GR253 and T1.105-3 standards.
Service disruption time (SDT) measurements	The service disruption time test tool measures the time during which there is a disruption of service due to the network switching from the active channels to the backup channels. Measurements: last disruption, shortest disruption, longest disruption, average disruption, total disruption, and service disruption count.
Round-trip delay (RTD) measurements	The round-trip delay test tool measures the time required for a bit to travel from the FTB-700G Series transmitter back to its receiver after crossing a far-end loopback. Measurements are provided on all supported FTB-700G Series interfaces and mappings. Measurements: last, minimum, maximum, average; measurement count: no. of successful RTD tests and failed measurement count.
APS message control and monitoring	Ability to monitor and set up automatic protection switching messages (K1/K2 byte of SONET/SDH overhead).
Synchronization status	Ability to monitor and set up synchronization status messages (S1 byte of SONET/SDH overhead).
Signal label control and monitoring	Ability to monitor and set up payload signal labels (C2, V5 byte of SONET overhead).
Tandem connection monitoring (TCM) <sup>a</sup>	Tandem connection monitoring (TCM) is used to monitor the performance of a subsection of a SONET/SDH path routed via different network providers. The FTB-700G Series supports transmitting and receiving alarms and errors on a TCM link; also, transmission and monitoring of the tandem connection (TC) trace can be generated to verify the connection between TCM equipment. Error generation: TC-IEC, TC-BIP, TC-REI, TC-OEI Error analysis: TC-IEC, TC-REI, TC-OEI, TC-VIOL (non-standardized alarm) Alarm generation: TC-RDI, TC-UNEQ, TC-ODI, TC-LTC, TC-IAIS Alarm analysis: TC-TIM, TC-RDI, TC-UNEQ, TC-ODI, TC-LTC, TC-IAIS
Through mode	Perform Through mode analysis of any incoming optical line (OC-1/STM-0, OC-3/STM-1, OC-12/STM-4, OC-48/STM-16, OC-192/STM-64) transparently.

**Note**

a. STS/AU and VT/TU supported as per ITU G.707 option 2.

OTN TEST FEATURES		
<b>OTN</b>	Standards compliance	ITU-T G.709, ITU G.798, ITU G.872
	Interfaces	OTU1 (2.6660 Gbit/s), OTU2 (10.7092 Gbit/s), OTU1e (11.0491 Gbit/s), OTU2e (11.0957 Gbit/s), OTU1f (11.2701 Gbit/s), OTU2f (11.3176 Gbit/s)
<b>OTU Layer</b>	Errors	OTU-FAS, OTU-MFAS, OTU-BEI, OTU-BIP-8
	Alarms	LOF, OOF, LOM, OOM, OTU-AIS, OTU-TIM, OTU-BDI, OTU-IAE, OTU-BIAE
	Traces	64-bytes Trail Trace Identifier (TTI) as defined in ITU-T G.709
<b>ODU TCM Layer</b>	Errors	TCMi-BIP-8, TCMi-BEI (i = 1 to 6)
	Alarms	TCMi-LTC, TCMi-TIM, TCMi-BDI, TCMi-IAE, TCMi-BIAE
	Traces	64-byte Trail Trace Identifier (TTI) as defined in ITU-T G.709
<b>ODU Layer</b>	Errors	ODU-BIP-8, ODU-BEI
	Alarms	ODU-AIS, ODU-OCI, ODU-LCK, ODU-TIM, ODU-BDI, ODU-FSF, ODU-BSF, ODU-FSD, ODU-BSL
	Traces	Generates 64-byte Trail Trace Identifier (TTI) as defined in ITU-T G.709
	FTFL <sup>b</sup>	As defined in ITU-T G.709
<b>OPU Layer</b>	Alarms	OPU-PLM, OPU-AIS, OPU-CSF
	Payload type (PT) label	Generates and displays received PT value
<b>Forward Error Correction (FEC)</b>	Errors	FEC-Correctable (Codeword), FEC-Uncorrectable (Codeword), FEC-Correctable (Symbol), FEC-Correctable (Bit), and FEC-Stress (Codeword)
<b>Pattern</b>	Patterns	2E-9, 2E-15, 2E-23, 2E-31, NULL, 32-bit programmable (inverted or noninverted)
	Error	Bit error
	Alarm	Pattern loss

ADDITIONAL OTN FUNCTION							
Frequency measurements	Supports clock frequency measurements (i.e., received frequency and deviation of the input signal clock from nominal frequency), displayed in ppm. Measurements are performed using a local oscillator.						
Frequency offset generation	Supports offsetting the clock of the transmitted signal on a selected interface to exercise clock recovery circuitry on network elements.						
Performance monitoring	The following ITU-T recommendations and corresponding performance monitoring parameters are supported on the FTB-700G Series. <table border="0" style="width: 100%;"> <tr> <td style="width: 50%;"><b>ITU-T recommendation</b></td> <td style="width: 50%;"><b>Performance monitoring statistics</b></td> </tr> <tr> <td>G.821</td> <td>ES, EFS, EC, SES, UAS, ESR, SESR, DM</td> </tr> <tr> <td>M.2100</td> <td>ES, SES, UAS, ESR, SESR</td> </tr> </table>	<b>ITU-T recommendation</b>	<b>Performance monitoring statistics</b>	G.821	ES, EFS, EC, SES, UAS, ESR, SESR, DM	M.2100	ES, SES, UAS, ESR, SESR
<b>ITU-T recommendation</b>	<b>Performance monitoring statistics</b>						
G.821	ES, EFS, EC, SES, UAS, ESR, SESR, DM						
M.2100	ES, SES, UAS, ESR, SESR						
Service disruption time (SDT) measurements	The service disruption time test tool measures the time during which there is a disruption of service due to the network switching from the active channels to the backup channels. Measurements: last disruption, shortest disruption, longest disruption, average disruption, total disruption, and service disruption count.						
Round-trip delay (RTD) measurements	The round-trip delay test tool measures the time required for a bit to travel from the transmitter back to its receiver after crossing a far-end loopback. Measurements are supported on all interfaces and mappings. Measurements: last RTD time, minimum, maximum, average, measurement count (no. of successful RTD tests) and failed measurement count.						
Through mode	Perform Through mode analysis of any incoming OTN signal transparently.						



## ETHERNET TEST FEATURES

EtherSAM (ITU-T Y.1564)	Perform service configuration and performance tests as per ITU-T Y.1564, including EBS, CBS and EMIX. Tests can be performed using remote loopback, or dual test set mode for bidirectional results.
RFC 2544	Throughput, back-to-back, frame loss and latency measurements according to RFC 2544. Frame size: RFC-defined sizes, user-configurable between 1-7 sizes.
Traffic generation and monitoring	Traffic generation and shaping of up to 16 streams of Ethernet and IP traffic, including the simultaneous monitoring of throughput, frame loss, packet jitter, latency and out-of-sequence frames.
Carrier Ethernet OAM	Supports four S-OAM modes, MEF, Y.1731, G.8113.1 (MPLS-TP) and 802.1ag. CCM generation and monitoring, loopback, test, frame loss, synthetic loss and frame delay. Alarm generation: AIS, RDI, LCK, CSF (C-LOS, C-RDI, C-FDI, C-DCI). Alarm monitoring: RDI, AIS, LCK, CSF, loss of continuity, mismerge, unexpected MEP, unexpected MEG/MD level; unexpected period supports S-OAM responder, S-OAM link trace, ping and traceroute, filters and packet capture.
Through mode	Sectionalize traffic between a service provider's network and customer premises equipment.
BER testing	Up to layer 4 supported with or without VLAN Q-in-Q.
Packet capture and filters	Ability to perform 10BASE-T all the way up to 10 GigE at full line rate with packet capture and decode. Ability to configure four filters with full decoding up to 10G including automatic triggers.
Patterns (BERT)	PRBS 2E9-1, PRBS 2E11-1, PRBS 2E15-1, PRBS 2E20-1, PRBS 2E23-1, PRBS 2E31-1 and one-user pattern. Capability to invert patterns.
Error measurement (BERT)	Bit error, bit mismatch 0, bit mismatch 1.
Error measurements	Jabber/giant, runt, undersize, oversize, FCS, symbol, alignment, collision, late collision, excessive collision, 10G block error.
Alarm detection	LOS, link down, pattern loss, frequency, 10G local/remote fault.
VLAN stacking	Generate streams with up to two layers of VLAN (including IEEE 802.1ad Q-in-Q tagged VLAN) traffic by VLAN ID or VLAN priority at any of the stacked VLAN layers.
MPLS	Capability to generate and analyze streams with up to two layers of MPLS labels and to filter received traffic by MPLS label or COS.
Cable testing	Category 5 cable (or better), 100 UTP/STP cable, ≤120 meters.
Service disruption time (SDT)	Includes statistics such as longest, shortest, last, average, count, total and pass/fail thresholds.
TCP throughput	True wire-speed, TCP throughput test for undisputable SLA reinforcement for Ethernet services.
One-way delay	Measurement of the one-way frame delay at up to 10G as part of EtherSAM (Y.1564) and RFC 2544.
IPv6 testing	Includes BERT, RFC 2544, traffic generation and monitoring, background streams, Smart Loopback, Remote Loopback, ping and traceroute.
10 GigE WAN testing	Includes WAN interface sublayer, J0/J1 trace and C2 label generation, J0/J1 trace and C2 label monitoring.
10 GigE WAN alarm monitoring	Includes SEF, LOF, AIS-L, RDI-L, AIS-P, RDI-P, LCD-P, LOP-P, PLM-P, UNEQ-P, ERDI-P, WIS link down, B1, B2, B3, REI-L, REI-P.

## ADDITIONAL FEATURES

FTTA BER testing	Includes BER measurement, bit error injection, round-trip delay measurement and pass/fail verdict for 1.2 to 9.8 Gbit/s rates.
1588 PTP	Validates 1588 PTP packet network synchronization services, emulates PTP clients, generates and analyzes messages between master/clients, clock quality level and IPDV.
SyncE	Validates SyncE frequency, ESMC messages and clock quality levels.
Power measurement	Supports power measurement at all times, displayed in dBm (dBdsx for DS1 and DS3), for optical and electrical interfaces.
Power-up and restore	In the event of a power failure to the unit, the active test configuration and test logger are saved and restored upon boot-up. Applicable to transport test applications only.
Save and load configuration	Store and load test configurations to/from a non-volatile USB memory stick or internal flash.
Pass/fail analysis	Provides a pass/fail outcome with user-adjustable thresholds, based on bit-error-rate and/or service disruption time.
Alarm hierarchy	Alarms are displayed according to a hierarchy based on root cause. Secondary effects are not displayed. This hierarchy serves to facilitate alarm analysis.
Report generation	Generate test reports on the unit or exported via USB.
Event logger	Log test results with absolute or relative time and date, details and duration of events, color-coded events and pass/fail outcome.
Remote control	Remote control via VNC or Remote Desktop.
Remote loopback	Detects other AXS-200/850, FTB-860 and FTB-700G Series units and sets them into Smart Loopback mode.
Dual test set	Detects and connects to any of EXFO's Ethernet testers to perform bidirectional RFC 2544 and EtherSAM testing.
Dual-port mode	Enables any Ethernet test, such as EtherSAM, RFC 2544, Traffic Generation and monitoring, or BERT to run directly to itself using one self-contained unit with loopback.
IP tools	Perform ping and traceroute functions.
Smart loopback	Return Ethernet traffic to the local unit by swapping packet overhead up to layer 4.

UPGRADES		
<b>SFP upgrades</b>	FTB-8590	SFP module GigE/FC/2FC, CPRI/OBSAI 2.45/3.07 Gbit/s at 850 nm, MM, <500 m
	FTB-85910	SFP modules 100 Base-FX, 1340 nm, MM, 2 km
	FTB-85911	SFP modules 100 Base-LX10, 1310 nm, SM, 15 km
	FTB-85912	SFP modules GigE/FC/2FC/4FC at 850 nm, <500 m
	FTB-8190	SFP module; rates: 155/622 Mbit/s, 2.5/2.7 Gbit/s, GigE/FC/2FC, CPRI/OBSAI 2.45/3.07 Gbit/s at 1310 nm, LC connector, 15 km reach
	FTB-8191	SFP module; rates: 155/622 Mbit/s, 2.5/2.7 Gbit/s, GigE/FC/2FC; CPRI/OBSAI 2.45/3.07 Gbit/s at 1310 nm, LC connector, 40 km reach
	FTB-8192	SFP module; rates: 155/622 Mbit/s, 2.5/2.7 Gbit/s, GigE/FC/2FC; 1550 nm, LC connector, 80 km reach
	FTB-8193	SFP module; rates: 155/622 Mbit/s, 2.5/2.7 Gbit/s, GigE/FC/2FC; 1550 nm, LC connector, 40 km reach
	FTB-85913	SFP modules GigE/FC/2FC/4FC at 1310 nm, 4 km
	FTB-85914	SFP modules GigE/FC/2FC/4FC at 1310 nm, 30 km
	FTB-85915	SFP modules GigE/FC/2FC/4FC at 1550 nm, <50 km
<b>SFP+ upgrades</b>	FTB-8600	SFP+ modules CPRI 1.228–9.83 Gbit/s at 1310 nm, LC connector, 1.4 km
	FTB-8691	SFP+ modules 10 GigE at 1310 nm, 10 km
	FTB-8693	SFP+ modules 9.953-10.709/11.3, 8FC/10FC/10 GigE at 1310 nm, SMF, 10 km
	FTB-8694	SFP+ modules 8FC/10FC/10 GigE at 1550 nm, 40 km
	FTB-8695	SFP+ modules 8FC/10FC/10 GigE at 1550 nm, 80 km
<b>Bidirectional SFP upgrades</b>	FTB-8596	SFP modules bidirectional 1490 Tx 1310 Rx 1000 BASE-BX10
	FTB-8597	SFP modules bidirectional 1310 Tx 1490 Rx 1000 BASE-BX10
	FTB-8598	SFP modules bidirectional 1310 Tx 1490/1550 Rx 1000 BASE-BX
	FTB-8599	SFP modules bidirectional 1550 Tx 1310 Rx 1000 BASE-BX

## GENERAL SPECIFICATIONS

Size (H x W x D)	130 mm x 252 mm x 56 mm (5 1/8 in x 9 15/16 in x 2 3/16 in) (module only)
Weight (without battery)	1.0 kg (2.2 lb)
Temperature	Operating: 0 °C to 50 °C (32 °F to 122 °F) Storage: -40 °C to 70 °C (-40 °F to 158 °F)
Relative humidity	0 % to 93 %, noncondensing
Battery life (extended)	OTDR = More than 6h taking 12 traces single per hour 1G = More than 4h 10G = More than 3h
Battery charging time	Two hours from full discharge to full charge
Languages	English, Chinese, Japanese and Korean

## LASER SAFETY

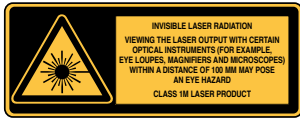

## 720G/730G ORDERING INFORMATION

FTB-7XXG-XX-XX-XX-XX-XX-XX-XX-XX-XX-XX

### Model

FTB-720G-23B = OTDR 1310 nm/1550 nm  
FTB-720G-12CD-23B = OTDR 850 nm/1300 nm, 1310 nm/1550 nm  
FTB-730G-23B = OTDR 1310 nm/1550 nm

### Model Options

Optical = Optical only (without Ethernet)  
Ethernet = Enables 10M to 1000M Electrical and GigE  
Combo = Enables Optical and Ethernet 10M to 1000M Electrical and GigE

### Base Software Options<sup>a</sup>

OTDR = Enables the OTDR application only  
iOLM = Enables the iOLM application only  
Oi = Enables iOLM and OTDR applications

### Multimode Connector<sup>b</sup>

EI-EUI-28 = UPC/DIN 47256  
EI-EUI-76 = UPC/HMS-10/AG  
EI-EUI-89 = UPC/FC narrow key  
EI-EUI-90 = UPC/ST  
EI-EUI-91 = UPC/SC  
EI-EUI-95 = UPC/E-2000  
EI-EUI-98 = UPC/LC

### Singlemode Connector

EA-EUI-28 = APC/DIN 47256  
EA-EUI-89 = APC/FC narrow key  
EA-EUI-91 = APC/SC  
EA-EUI-95 = APC/E-2000

### CPRI Rate Options

CPRI 4.9G<sup>c</sup>  
CPRI 6.1G<sup>c</sup>

### Ethernet Rate Option<sup>d</sup>

100optical = Enables 100 Mbit/s optical<sup>e</sup>

### Fiber Channel Options<sup>d</sup>

FC1X = Enables 1x Fibre Channel interface  
FC2X = Enables 2x Fibre Channel interface  
FC4X = Enables 4x Fibre Channel interface

### Ethernet Software Options<sup>d</sup>

Cable\_test = Cable test  
IPV6 = Internet protocol version 6  
ETH-THRU = Enables Through mode capability  
MPLS = Enables MPLS  
CPRI-OBSAI = Enables 1.2G to 3.1G CPRI, and 3.1G OBSAI<sup>b</sup>  
1588PTP = Generates and analyzes 1588 PTP  
SYNCE = Generates and analyzes SyncE protocol  
TCP-THPUT = TCP throughput  
ETH-OAM = Enables Y.1731, G.8113.1 (MPLS-TP), 802.1ag and MEF  
ADV-FILTERS = Advanced filtering  
ETH-CAPTURE = Full line-rate packet capture

### Software 700G Series<sup>g</sup>

AD = Auto-diagnostic (macro bend detection, pass/fail and fault finder)<sup>f</sup>  
EC = Event characterization (bidirectional analysis and Template mode)<sup>f</sup>  
RT = Real-time OTDR mode (via iOLM application)<sup>g</sup>  
iEX = iOLM Expert mode<sup>h</sup>

Example: FTB-720G-23B-Optical-iOLM-EA-EUI-89-RT-iEX

## EI CONNECTORS



To maximize the performance of your OTDR, EXFO recommends using APC connectors. These connectors generate lower reflectance, which is a critical parameter that affects performance, particularly dead zones. APC connectors provide better performances than UPC connectors, thereby improving testing efficiency.

Note: UPC connectors are also available, simply replace EA-XX by EI-XX in the ordering part number. Additional connectors available are the EI-EUI-76 (UPC/HMS-10/AG) and EI-EUI-90 (UPC/ST).

### Notes

- a. Available if no Ethernet option selected.
- b. Available for model FTB-720G-12CD-23B only.
- c. Requires purchase of SFP.
- d. Available if Ethernet option selected.
- e. Available if Base Software selected.
- f. Includes if OTDR or Oi Base software selected.
- g. Available for iOLM software only.
- h. Available with iOLM or Oi Base software selected.

## 720G+/730G+ ORDERING INFORMATION

FTB-7XXG+-XX-XX-XX-XX-XX-XX-XX-XX-XX-XX-XX-XX-XX-XX-XX-XX

### Model

FTB-720G+-23B = OTDR 1310 nm/1550 nm  
 FTB-720G+-12CD-23B = OTDR 850 nm/1300 nm,  
 1310 nm/1550 nm  
 FTB-730G+-23B = OTDR 1310 nm/1550 nm

### Model Options

Optical = Optical only (without Ethernet)  
 Ethernet = Enables 10M to 1000M Electrical and GigE  
 Combo = Enables Optical and Ethernet 10M to 1000M  
 Electrical and GigE

### Base Software Options<sup>a</sup>

OTDR = Enables the OTDR application only  
 iOLM = Enables the iOLM application only  
 Oi = Enables iOLM and OTDR applications

### Multimode Connector<sup>b</sup>

EI-EUI-28 = UPC/DIN 47256  
 EI-EUI-76 = UPC/HMS-10/AG  
 EI-EUI-89 = UPC/FC narrow key  
 EI-EUI-90 = UPC/ST  
 EI-EUI-91 = UPC/SC  
 EI-EUI-95 = UPC/E-2000  
 EI-EUI-98 = UPC/LC

### Singlemode Connector

EA-EUI-28 = APC/DIN 47256  
 EA-EUI-89 = APC/FC narrow key  
 EA-EUI-91 = APC/SC  
 EA-EUI-95 = APC/E-2000

### Software 700G Series<sup>c</sup>

AD = Auto-diagnostic (macroband detection, pass/fail and fault finder)<sup>d</sup>  
 EC = Event characterization (bidirectional analysis and Template mode)<sup>d</sup>  
 RT = Real-time OTDR mode (via iOLM application)<sup>e</sup>  
 iEX = iOLM EXpert mode<sup>f</sup>

### Transport Base Options<sup>g</sup>

SONET = SONET testing  
 SDH = SDH testing  
 SONET-SDH = SONET and SDH testing

### CPRI Rate Options

CPRI 4.9G<sup>h</sup>  
 CPRI 6.1G<sup>h</sup>  
 CPRI 9.8G<sup>h</sup>

### Transport Rate Options<sup>g</sup>

52M = 52 Mbit/s (OC-1/STM-0)<sup>i,j</sup>  
 155M = 155 Mbit/s (OC-3/STM-1)<sup>j</sup>  
 622M = 622 Mbit/s (OC12/STM-4)<sup>j</sup>  
 2488M = 2.5 Gbit/s (OC48/STM-16)<sup>j</sup>  
 9953M = 10 Gbit/s (OC192/STM-64)<sup>h</sup>

### Ethernet Rate Option<sup>g</sup>

100optical = Enables 100 Mbit/s optical<sup>j</sup>  
 10GigE = Enables 10 GigE LAN/WAN<sup>h</sup>

### Fiber Channel Options<sup>l</sup>

FC1X = Enables 1x Fibre Channel interface<sup>l</sup>  
 FC2X = Enables 2x Fibre Channel interface<sup>l</sup>  
 FC4X = Enables 4x Fibre Channel interface<sup>l</sup>  
 FC8X = Enables 8x Fibre Channel interface<sup>l</sup>  
 FC10X = Enables 10x Fibre Channel interface<sup>h</sup>

### Transport Software Options<sup>g</sup>

00 = Without Transport Software option  
 TCM = Tandem connection monitoring

### Ethernet Software Options<sup>g</sup>

Cable\_test = Cable test  
 IPV6 = Enables Internet protocol version 6  
 ETH-THRU = Enables Through mode capability  
 MPLS = Enables MPLS  
 CPRI-OBSAI = Enables 1.2G to 3.1G CPRI, and 3.1G OBSAI<sup>g</sup>  
 1588PTP = Generates and analyzes 1588 PTP  
 SYNCE = Generates and analyzes SyncE protocol  
 TCP-THPUT = TCP throughput  
 ETH-OAM = Enables Y.1731, G.8113.1 (MPLS-TP),  
 802.1ag and MEF  
 ADV-FILTERS = Advanced filtering  
 ETH-CAPTURE = Full line-rate packet capture

### OTN Rate Options

00 = Without OTN rate option  
 OTU1 = OTN optical rate 2.666 Gbit/s<sup>j</sup>  
 OTU2 = OTN optical rate 10.709 Gbit/s<sup>h</sup>  
 OTU2-1e-2e = OTN optical rates 11.049/11.096 Gbit/s<sup>h</sup>  
 OTU2-1f-2f = OTN optical rates 11.270/11.318 Gbit/s<sup>h</sup>

Example: FTB-730G+-23B-Optical-iOLM-EA-EUI-89-RT-iEX

## EI CONNECTORS



To maximize the performance of your OTDR, EXFO recommends using APC connectors. These connectors generate lower reflectance, which is a critical parameter that affects performance, particularly dead zones. APC connectors provide better performances than UPC connectors, thereby improving testing efficiency.

Note: UPC connectors are also available, simply replace EA-XX by EI-XX in the ordering part number. Additional connectors available are the EI-EUI-76 (UPC/HMS-10/AG) and EI-EUI-90 (UPC/ST).

### Notes

- |                                                   |                                                      |
|---------------------------------------------------|------------------------------------------------------|
| a. Available if no Ethernet option selected.      | f. Available with iOLM or Oi Base software selected. |
| b. Available for model FTB-720G+-12CD-23B only.   | g. Available if Ethernet option selected.            |
| c. Available if Base Software selected.           | h. Requires purchase of SFP+.                        |
| d. Included if OTDR or Oi Base software selected. | i. Included if Ethernet selected.                    |
| e. Available for iOLM software only.              | j. Requires purchase of SFP.                         |

EXFO Headquarters > Tel.: +1 418 683-0211 | Toll-free: +1 800 663-3936 (USA and Canada) | Fax: +1 418 683-2170 | info@EXFO.com | [www.EXFO.com](http://www.EXFO.com)

EXFO serves over 2000 customers in more than 100 countries. To find your local office contact details, please go to [www.EXFO.com/contact](http://www.EXFO.com/contact).

EXFO is certified ISO 9001 and attests to the quality of these products. EXFO has made every effort to ensure that the information contained in this specification sheet is accurate. However, we accept no responsibility for any errors or omissions, and we reserve the right to modify design, characteristics and products at any time without obligation. Units of measurement in this document conform to SI standards and practices. In addition, all of EXFO's manufactured products are compliant with the European Union's WEEE directive. For more information, please visit [www.EXFO.com/recycle](http://www.EXFO.com/recycle). Contact EXFO for prices and availability or to obtain the phone number of your local EXFO distributor.

For the most recent version of this spec sheet, please go to the EXFO website at [www.EXFO.com/specs](http://www.EXFO.com/specs).

In case of discrepancy, the Web version takes precedence over any printed literature.

