

[Fluke 41 Specs](#)  
Provided by [www.AAATesters.com](http://www.AAATesters.com)

Model 40 Power  
Harmonics  
Meter

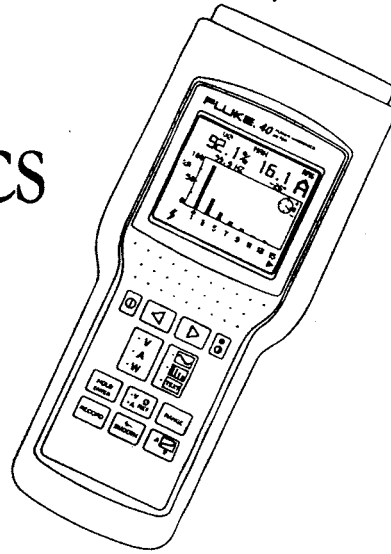

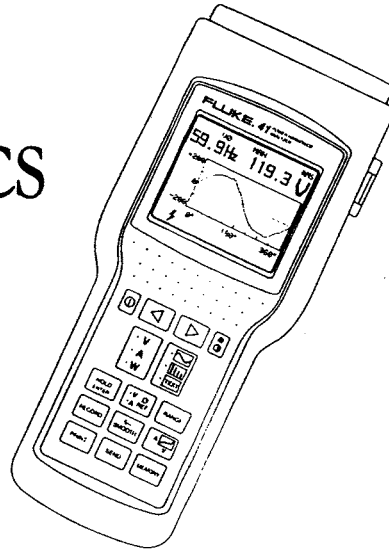









Model 41 Power  
Harmonics  
Analyzer



PN 942847  
February 1994  
©1994 Fluke Corporation. All rights reserved. Printed in U.S.A.  
All product names are trademarks of their respective companies.

**FLUKE.**

# Table of Contents

CONTENTS	PAGE
SAFETY .....	1
UNPACKING .....	3
USES FOR THE TESTER .....	6
TERMINOLOGY USED IN THIS MANUAL .....	6
BATTERY CONSIDERATIONS .....	7
MEMORY RETENTION .....	7
AUTOMATIC POWER DOWN .....	7
 GETTING ACQUAINTED WITH YOUR TESTER .....	8
INPUT CONNECTIONS .....	10
Using the Voltage Test Leads .....	10
Using the Current Probe .....	11
THREE PHASE POWER MEASUREMENTS .....	12
KEYPAD .....	14
DISPLAY SCREEN .....	19
  FUNCTIONS AND SCREEN MODES .....	25
Waveform Screen Mode .....	25
Harmonics Screen Mode .....	27
Text Screen Mode .....	27
 VA CHECK .....	30
 RECORDING MEASUREMENTS .....	32
 +  POWER-UP CONFIGURATION .....	34
 STORING MEASUREMENTS (MODEL 41) .....	36
COMMUNICATIONS .....	38
 PRINTING (MODEL 41) .....	38
 SENDING TO A PC (MODEL 41) .....	38

## CONTENTS

	PAGE
APPLICATIONS .....	40
Plant Switch Gear .....	41
Distribution Transformer .....	42
Electronic Equipment Load Center .....	43
Generator Set .....	44
Adjustable Frequency (Speed) Drive .....	45
USER MAINTENANCE .....	46
Cleaning .....	46
Battery Replacement .....	46
Operational Test .....	48
If Your Tester Does Not Work .....	48
ACCESSORIES AND REPLACEMENT PARTS .....	49
SPECIFICATIONS .....	50

## List of Tables

TABLE	PAGE
1. Key Descriptions .....	15
2. Status Line .....	20
3. Screen Abbreviations .....	21
4. Special Messages .....	24

# List of Illustrations

FIGURE		PAGE
1.	International Electrical Symbols .....	1
2.	Tester and Accessories (Models 40/41) .....	4
3.	Additional Items (Model 41) .....	5
4.	Getting Acquainted .....	9
5.	Measurement Connections (1 $\emptyset$ ) .....	11
6.	Measurement Connections (3 $\emptyset$ , 3 Wire) .....	12
7.	Measurement Connections (3 $\emptyset$ , 4 Wire) .....	13
8.	Keypad .....	14
9.	Display Screen .....	19
10.	Waveform Screens .....	26
11.	Harmonics Screens .....	28
12.	Text Screens .....	29
13.	VA Check  Signatures .....	31
14.	Record Screens .....	33
15.	Configuration Screens .....	35
16.	Memory Screen .....	36
17.	Serial Communications .....	39
18.	Plant Switch Gear .....	41
19.	Distribution Transformer .....	42
20.	Electronic Equipment Loads .....	43
21.	Generator Set .....	44
22.	Adjustable Frequency (Speed) Drive .....	45
23.	Battery Replacement .....	47

# USING YOUR TESTER SAFELY



## WARNING

TO AVOID ELECTRIC SHOCK, USE ONLY THE TEST LEADS SUPPLIED WITH THE TESTER. USE 600V RATED PROBE TIP ADAPTERS. ("600V" IS PRINTED ON EQUIPMENT SO RATED.) REMOVE ALL TEST LEADS THAT ARE NOT IN USE.

USE ONLY THE 80i-500s AC CURRENT PROBE OR A SAFETY-DESIGNED EQUIVALENT (SUCH AS THE FLUKE MODEL 80i-1000s) THAT IS RATED FOR 600V ON BOTH THE JAWS AND THE MEASURING SECONDARY. REMOVE ANY CURRENT PROBE THAT IS NOT IN USE. USE OF THE TESTER IN A MANNER NOT SPECIFIED MAY IMPAIR SAFETY.

In this manual, a WARNING identifies conditions and actions that pose hazard(s) to the user. A Caution identifies conditions and actions that may damage the tester or the current probe. See Figure 1 for explanations of international electrical symbols.

Read the following safety information carefully before attempting to operate or service the tester or the current probe.









	DANGEROUS VOLTAGE		CAUTION see explanation in manual
	AC-ALTERNATING CURRENT		Equipment protected throughout by DOUBLE INSULATION or REINFORCED INSULATION
	DC-DIRECT CURRENT		
	Either DC or AC		RECYCLING
	EARTH		HIGH BNC INPUT

Figure 1. International Electrical Symbols

---

## Tester and Voltage Probe Safety Guidelines

To ensure that you use your tester safely, follow these safety guidelines:

- Avoid working alone.
- Inspect the test leads for damaged insulation or exposed metal. Check test lead continuity with a multimeter. Replace damaged leads.
- Do not use the tester if it looks damaged.
- When using the voltage test leads, keep your fingers away from probe contacts. Keep your fingers behind the finger guards on the probes.
- Use caution when working above 60V dc or 30V ac rms. Such voltages pose a shock hazard.

## AC Current Probe Safety Guidelines

Follow these safety guidelines when using the AC Current Probe:

-  Never use the 80i-500s current probe on circuits rated higher than 600V. Use extreme caution when clamping the current probe around un-insulated conductors or bus bars.
- Keep your fingers behind the finger guard on the 80i-500s.
- Check the magnetic mating surfaces of the probe jaws; these should be free of dirt, dust, rust, or other foreign matter.
- Do not use a current probe that has been cracked or damaged or has defective leads. If there is any such sign of impaired operation, tape the probe shut to prevent operation.
- The 80i-500s has been designed and tested according to IEC Publication 1010 and other safety standards. Follow all warnings to ensure safe operation.

## UNPACKING

The following items should be in your tester kit (see Figure 2):

- 1 Model 40 Power Harmonic Meter or Model 41 Power Harmonic Analyzer
- 1 80i-500s AC Current Probe
- 2 TL-24 Test Leads
- 2 TP-20 Test Probes
- 2 AC-20 Test Clips

Your kit should also include the following printed materials:

- 1 Users Manual (this book)
- 1 Quick Reference Card
- 1 Warranty Registration Card

For Model 41 only, check for the additional items shown in Figure 3.

Check the contents for completeness, noting any damage. If something in the kit has been damaged or is missing, contact the supplier immediately.

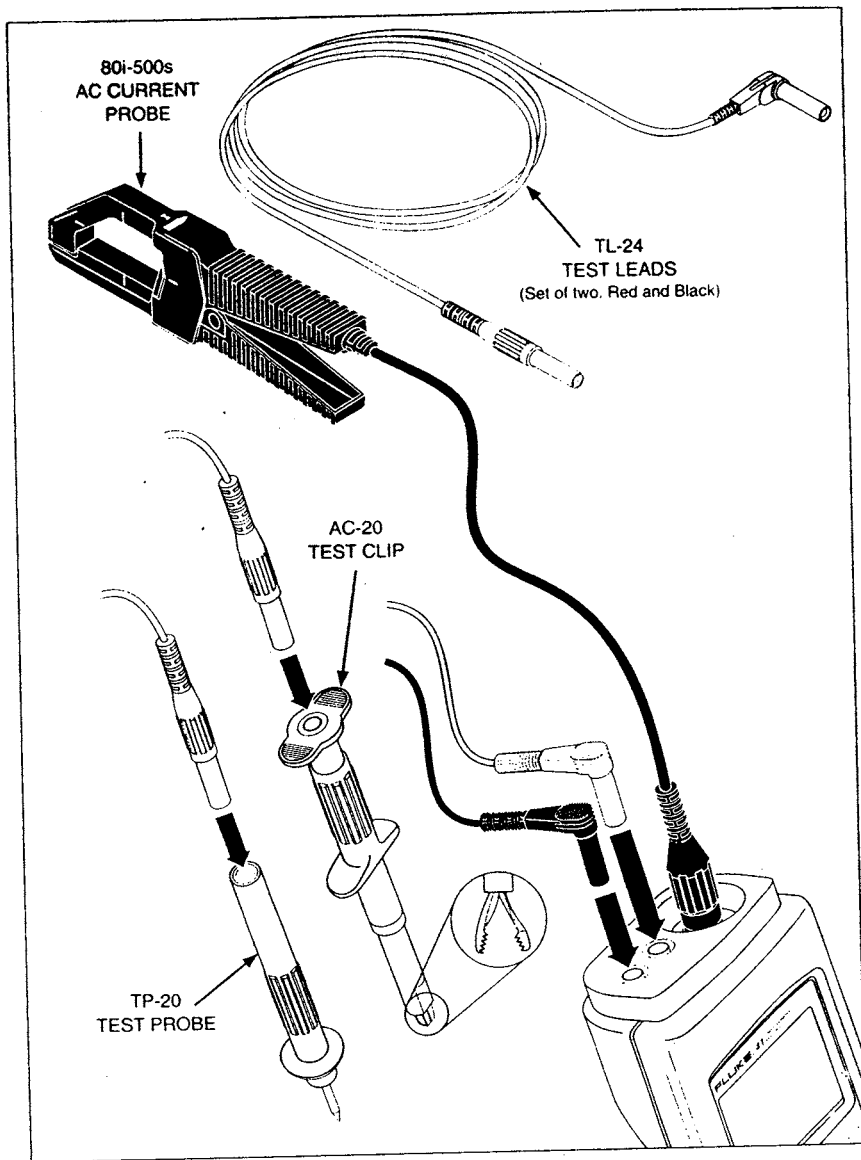

Figure 2. Tester and Accessories (Models 40/41)



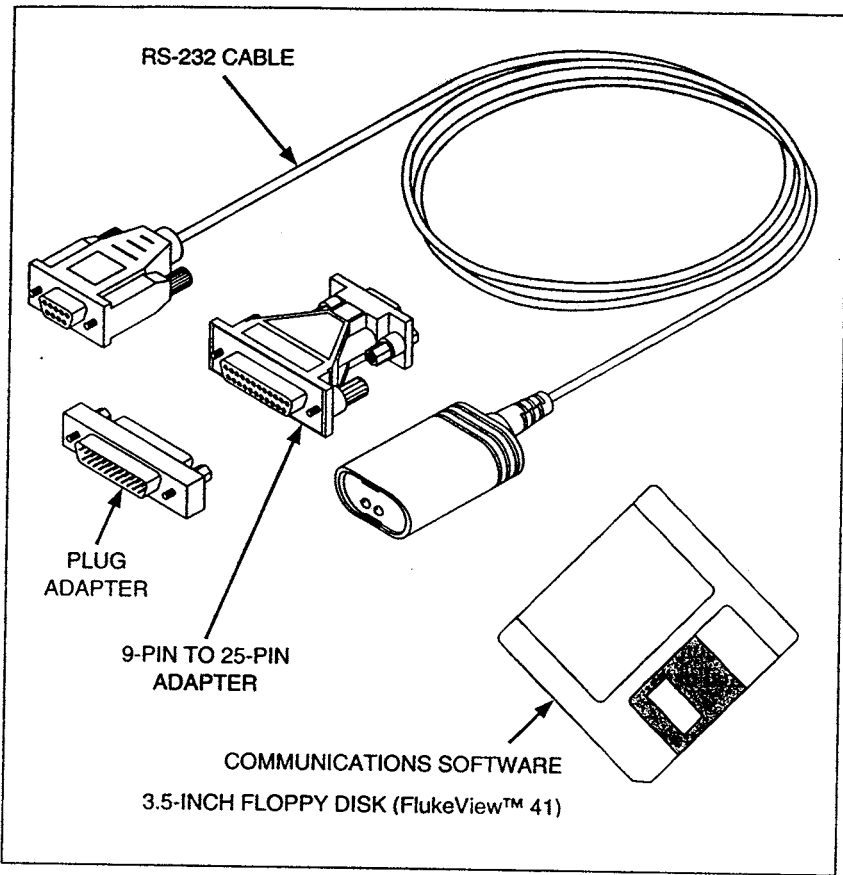

Figure 3. Additional Items (Model 41)

## USES FOR THE TESTER

You can use the Tester to measure voltage and current inputs at power line and harmonic frequencies. Using these inputs, the Tester automatically calculates power and a wide range of other measurements useful in determining harmonic distortion levels and sources.

These capabilities allow you to monitor power quality before and after an installation, troubleshoot a power distribution system, and (with Model 41) print out or download data for additional analysis.

The Tester is both a harmonics measurement tool and a power meter or digital multimeter. You can use the Tester to measure voltage events (undervoltage, overvoltage, line outages, and neutral to ground levels), current levels, or to measure power levels. Fundamental frequency measurements (to 100 Hz) and harmonic frequency measurements (to about 2 kHz) are also possible.

The Tester cannot measure frequencies above about 2 kHz. (Use the ScopeMeter® test tool to measure fast power transients.)

## TERMINOLOGY USED IN THIS MANUAL

This manual uses the following standard terminology:

- “Mains” is line voltage or frequency.
- “ $\phi 1$ ”, “ $\phi 2$ ”, and “ $\phi 3$ ” refer to the three current supply phases.
- “Delta”  $\triangle$  is a 3-Wire, 3-Phase distribution circuit.
- “Wye”  $\odot$  is a 4-Wire, 3-Phase distribution circuit.
- “N” is Neutral
- $\perp$  is Earth ground.
- “AC Current Probe” or “Probe” refers to the 80i-500s, which can also be called a “current clamp”.

## BATTERY CONSIDERATIONS

New alkaline C cells provide more than 24 hours of continuous operation. You can also use NiCad batteries; however, depending on battery condition, fully charged NiCad batteries provide 8 hours or less of continuous operation.

Plan to replace the batteries as soon as possible after the  symbol comes on. Refer to User Maintenance later in this manual for battery changing instructions.

## MEMORY RETENTION

Whenever you remove power from the Tester (by pressing  off, letting the batteries run down, removing the batteries, or experiencing an automatic power down), the Tester retains all essential operating information in nonvolatile memory. Specifically, the Tester retains calibration accuracy, power-up configuration information, and any stored waveforms (Model 41). However, if you remove power when Record is active, the Tester loses all recorded values.

## AUTOMATIC POWER DOWN

If you do not press any keys for approximately 15 minutes, the Tester normally powers down automatically. If Record is active, the Tester continues to operate unattended as long as the battery condition allows.

The Tester returns to its power-up configuration whenever you turn it on.













If the Tester encounters a memory error at power-up, it automatically turns itself off. Check the batteries and try turning the Tester on again. If this problem persists, contact a Fluke Service Center (listed at the end of this manual.)

## GETTING ACQUAINTED WITH YOUR TESTER

### NOTE

*The Fluke 40 Power Harmonics Meter and the Fluke 41 Power Harmonics Analyzer share many features and are collectively referred to as "the Tester" in this manual. "Model 41" is mentioned when a description pertains only to this model. Model 41 is shown in all illustrations.*

Refer to Figure 4. Following the numbers, press some keys to familiarize yourself with Tester features.

1.  to turn the Tester on.
2.  (brief press) and  or  to change screen contrast.  
 (hold 1 second) to turn the backlight on or off.
3.  to select a measurement function (Volts, Amps, Watts).
4.  to select a screen mode (Waveform, Harmonics, Text).
5.  to start recording measurements  
 or  to select NOW, MAX, AVG, MIN recording.  
 to select a different measurement function while recording.  
 to exit recording.
6.  to turn the Tester off.

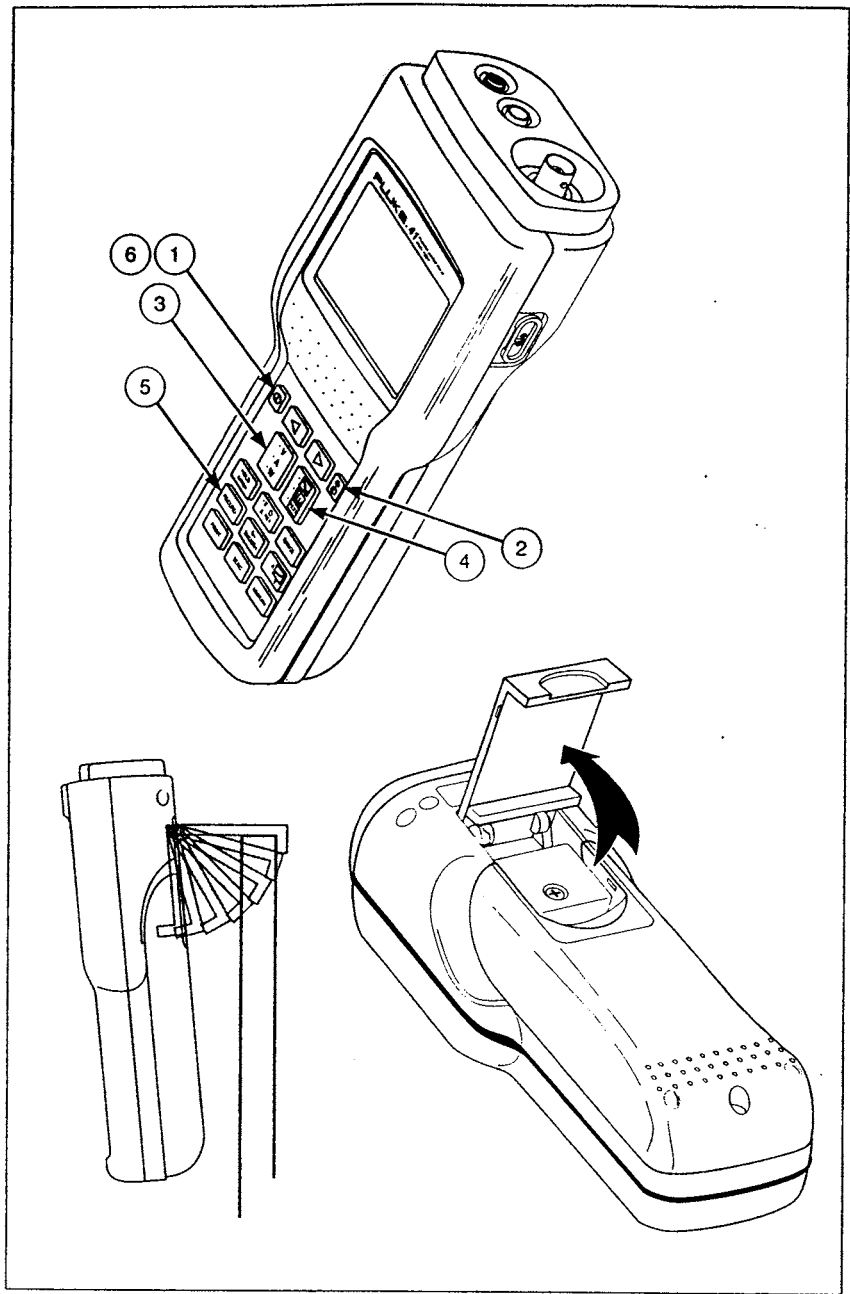

Figure 4. Getting Acquainted

## INPUT CONNECTIONS

Refer to Figure 2 for a view of the two-input measurement scheme. Voltage measurement uses a red test lead attached to "V" and a black test lead attached to "COM". Current measurement uses a BNC connector attached to "CURRENT PROBE". Connect "V" and "COM" to measure only voltage; connect "CURRENT PROBE" to measure only current. Make all three connections for power measurements.

Observe the following connection guidelines:

- Current

Clamp the Current Probe around the desired phase conductor. Make sure the arrow on the probe points toward the load. The Tester is set up for use with an 80i-500s Current Probe. If you use another probe, you must make a selection change in the Configuration Screen.

- Voltage: Wye Circuit  $\odot$ , 4-Wire

Connect the red test lead to the desired phase voltage; connect the black test lead to N.

- Voltage: Delta Circuit  $\triangle$ , 3-Wire

Connect the red test lead to the phase conductor used by the Current Probe; connect the black test lead to the reference phase.

### Using the Voltage Test Leads

Refer to Figure 2 for a view of test leads and adapters included with your Tester. The TL-24 Test Lead and AC-20 Test Clip combination, which allows for hands-free voltage measurements, is preferred when you are also using the Current Probe.

#### NOTE

*Figure 5 shows suggested test lead and current probe usage.*

## Using the Current Probe

Accuracy of current and power readings depends on proper use of the 80i-500s Current Probe. The accuracy specifications in this manual assume that the Current Probe is used correctly.

- Always clamp the 80i-500s Current Probe with the arrow pointing toward the load (away from the source) for a phase measurement or toward the source for an N measurement. Press  to verify the Current Probe orientation: if the resulting VA Check Screen generally extends from the lower left to the upper right of the screen, the Current Probe is connected properly.
- Always clamp the Current Probe around a single conductor or parallel conductors that are carrying current for the same phase.
- Always center the conductor in the Current Probe alignment marks.

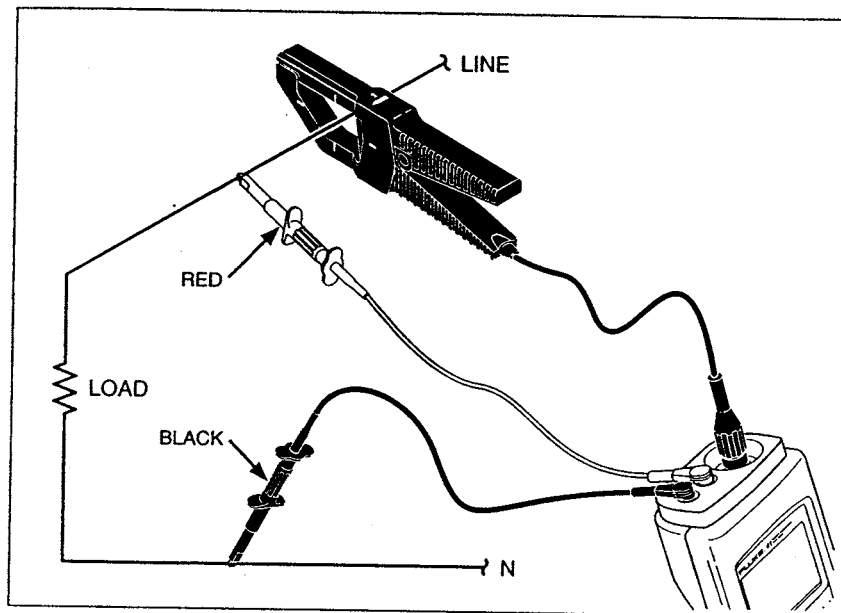

Figure 5. Measurement Connections (1 $\phi$ )

## Three-Phase Power Measurements

Refer to Figures 6 and 7 for suggested ways to measure total power in a three-phase system.

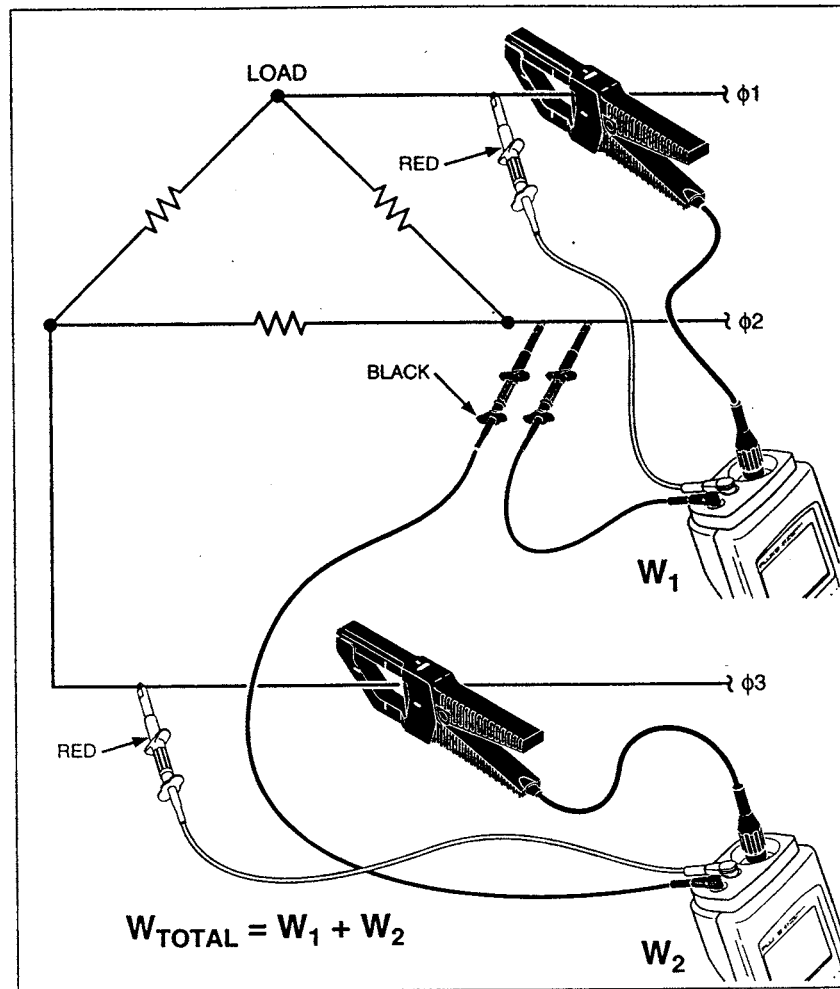

Figure 6. Measurement Connections (3 $\phi$ , 3 Wire,  $\Delta$  or  $Y$ )



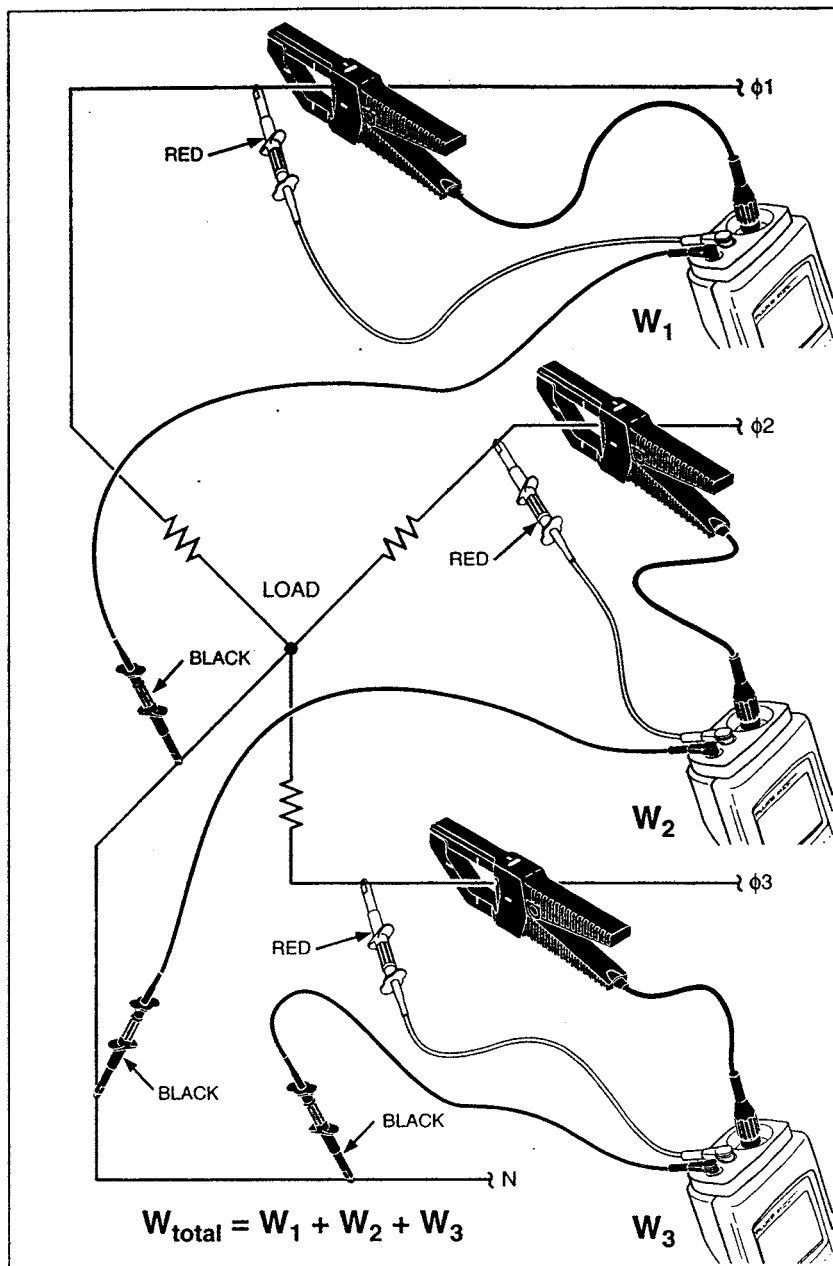

Figure 7. Measurement Connections (3 $\phi$ , 4 Wire)

# KEYPAD

Refer to Figure 8 and Table 1 for keypad operation.

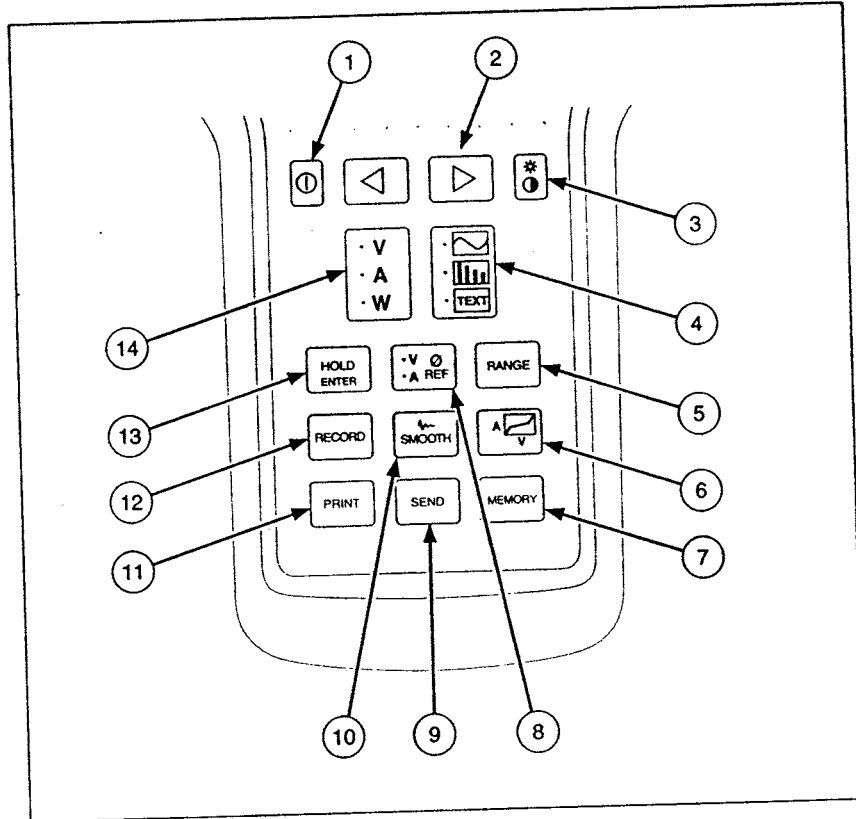

Figure 8. Keypad

**Table 1. Key Descriptions**











NUMBER	NAME & DESCRIPTION
1	 <b>Power</b> Press once to turn the Tester on; a test pattern is displayed briefly. (Test pattern remains displayed while key is held pressed.) Press again to turn the Tester off. The Tester sets up to the power-up configuration each time you turn it on.
2	  These keys have multiple uses. Refer to other areas for specific  and  descriptions.
3	 <b>Contrast/Backlight</b> Tap briefly to adjust contrast (with   ); tap again to return to normal operation. Press and hold  for about 1 second to turn the backlight on or off.
4	 <b>Screen Mode</b> Press to cycle the Tester through Waveform, Harmonics, and Text Screen Modes. You select the Measurement Function (Volts, Amps, or Watts) independently of the Screen Mode.

Table 1. Key Descriptions (cont)









NUMBER	NAME & DESCRIPTION
5	<p> Range</p> <p>Press  momentarily to start manual ranging (MAN) for all Measurement Functions (V, A, W). Continue momentary presses to cycle through the ranges for the selected Measurement Function only. (Ranges do not change for the other two Measurement Functions.) Press and hold about 1 second to return to autoranging (AUTO) for all Measurement Functions (V, A, W). The Tester always begins autoranging at power-up.</p>
6	<p> VA Check</p> <p>Press at any time for a check of the volts versus amps signature at the test point. Press  a second time to return to normal operation.</p>
7	<p> Memory (Model 41)</p> <p>Press to access the Waveform Storage Screen. Press  a second time to return to normal operation. Also, you can clear all stored waveforms by holding  pressed as you press  on.</p>

Table 1. Key Descriptions (cont)





















NUMBER	NAME & DESCRIPTION
8	<p> Phase Reference</p> <p>Press to select volts or amps as the display phase reference. Voltage reference is the standard configuration. For current only measurements, press  to set A∅. Change the power-up phase reference selection on the Configuration Screen.</p>
9	<p> Send (Model 41)</p> <p>Press to send calculated measurements to a PC. (The Tester displays SEND.) Press  a second time to return to normal operation.</p>
10	<p> Smooth</p> <p>Smooth allows you to average waveforms, resulting in a more stable screen and increased accuracy of computations. (See "Specifications".) With the Tester in Waveform Mode, press  four times to step through the Smooth selections (<math>\sim 2s</math>, <math>\sim 5s</math>, <math>\sim 10s</math>, <math>\sim 20s</math> in the top status line). Pressing  a fifth time returns the Tester to normal operation.</p>

Table 1. Key Descriptions (cont)

NUMBER	NAME & DESCRIPTION
11	<p> Print (Model 41)</p> <p>Press to send data to a printer. (The Tester displays ) To stop printing, press any key.</p>
12	<p> Record</p> <p>Press to start Record. Press  a second time to resume normal operation. You can also return the Tester to its standard (factory-programmed) configuration by holding  pressed as  is pressed on.</p>
13	<p> Hold</p> <p>Press  to freeze the screen ( appears in the top line). You can now observe all screens for a single measurement. Press  again to resume normal operation.</p> <p> serves as the "ENTER" key when used with some other screens. Also, you can access the Power-Up Configuration Screen by pressing  as you press  on.</p>
14	<p> Measurement Function</p> <p>Press to cycle the Tester through Volts, Amps, and Watts Measurement Functions. You select the Screen Mode (Waveform, Harmonic, or Text) independently of the Measurement Function.</p>

## DISPLAY SCREEN

The screen consists of the following three areas (see Figure 9):

- Status Line - identifies Tester operating conditions. See Table 2.
- Measurement Area - shows information as waveform, harmonics bar chart, or set of text computations. Refer to Table 3 for abbreviated terms used in all Measurement Functions and Screen Modes.
- Special Messages. See Table 4.

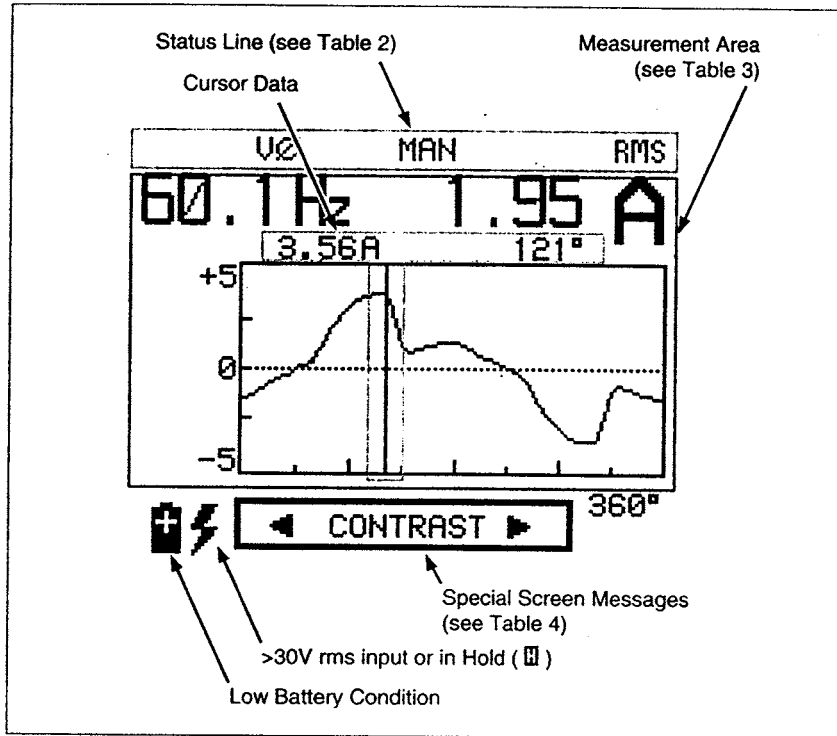

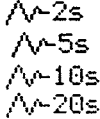
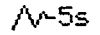
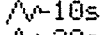
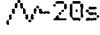

Figure 9. Display Screen

Table 2. Status Line

	Hold active (screen frozen).  appears in lower left screen to indicate possible high voltage input that is not displayed in Hold.
V $\emptyset$ A $\emptyset$	Phase Reference Selection. The volts input or the current input is the reference for determining phase shift.
 -2s  -5s  -10s  -20s	Smooth Selection. Smooth is active with averaging times of 2,5,10, or 20 seconds. A higher number signifies a more stable measurement reading.
OL-V	Volts Overload Condition for the selected range (over 600V if in AUTO)
OL-A	Amps Overload Condition for the selected range (exceeds 2V peak if in AUTO). Since the input from the Current Probe is 1 mV/A, maximum current input is 2000A pk.
OL-VA	Both volts and amps maximum inputs have been exceeded.

**NOTE**

*When an overload occurs, all measurement and computation data must be presumed invalid.*

AUTO	The Tester switches range automatically to deal with changing volts, amps, or watts readings.
MAN	Tester does not switch ranges automatically.
SEND	Send Active (Model 41)
PRNT	Print Active (Model 41)



**Table 3. Screen Abbreviations**

SCREEN USAGE	NAME AND DESCRIPTION
° 	Phase Angle degrees.
A RMS	Amps RMS (includes dc component)
A PK	Peak Amps (1/2 peak-to-peak value)
A DC	Amps DC
A HM	Harmonic Amps RMS
	For a current waveform, A HM identifies the total harmonic current present.
A LEAD	Amps Lead Volts
	Evidence of capacitive reactance in the system; the current waveform precedes the voltage waveform.
A LAG	Amps Lag Volts
	Evidence of inductive reactance in the system; the current waveform occurs after the voltage waveform.
CF	Crest Factor
	Ratio of a waveform's peak value to its rms value.

**Table 3. Screen Abbreviations (cont)**

SCREEN USAGE	NAME AND DESCRIPTION
DPF	<p>Displacement Power Factor</p> <p>The ratio of the active power (W) to the apparent power (VA rms) at the fundamental frequency. Equivalent to <math>\cos \phi</math> at that frequency.</p>
HZ	<p>Frequency in Hertz</p>
KF	<p>K-Factor (Model 41)</p> <p>A transformer rating calculation for harmonics tolerance.</p>
PF	<p>Power Factor</p> <p>Ratio of active power to apparent power (including all harmonics).</p>
% THD-F	<p>Total Harmonic Distortion (as % of Fundamental)</p> <p>Defines amount of harmonic distortion as a percentage of the waveform at the fundamental frequency.</p>
% THD-R	<p>Total Harmonic Distortion (as % of rms total)</p> <p>Defines amount of harmonic distortion as a percentage of the rms value of waveforms at all frequencies (fundamental and harmonics).</p>
V RMS	<p>Volts RMS (includes dc component)</p>
COS (∅)	<p>Cosine of the angle between the voltage and the current at any single frequency.</p>

**Table 3. Screen Abbreviations (cont)**

<b>SCREEN USAGE</b>	<b>NAME AND DESCRIPTION</b>
V PK	Peak Volts (1/2 peak-to-peak value)
V DC	Volts DC
V HM	Harmonic Volts RMS
	For a voltage waveform, V HM identifies the total harmonic voltage present.
VA, KVA	(Kilo) Volt Amps
	Apparent power - a value that the Tester calculates by multiplying the rms value for current by the rms value for voltage.
VAR, KVAR	(Kilo) Volt Amps Reactive
	The reactive power component of the fundamental frequency.
W, KW	Active Power
	The average power dissipated. (Also called real power.)

Table 4. Special Messages

<CONTRAST>

Press  or  to adjust contrast. Press  to exit contrast control.

\* CALIBRATION ERROR \*  
CONTACT FLUKE SERVICE

The Tester has detected a calibration error at power-up. Since erroneous readings result, the Tester displays this message until calibration is verified. Return the Tester to a Service Center for repair or calibration. See "User Maintenance" later in this manual.

STOP AVG AT 48 HOURS

In Record, averaging stops after 48 hours. Note the average value shown, then press  once to return to normal operation or twice to begin recording with new values.

\* PRINTING \*  
PRESS ANY KEY TO STOP

On Model 41, this message appears when you press . Press any key to resume normal operation.





## FUNCTIONS AND SCREEN MODES

The Tester uses a set of nine multipurpose screens to present each type of measurement (Volts, Amps, Watts) as a Waveform, a relational bar chart of Harmonics, or a series of digital (Text) readouts. With multiple values and computations on each screen, you only need to press a few keys to see everything there is to know about power (or just voltage or current) at the test point. Cycle through the choices by pressing either (or both) of these keys.

The Tester preserves selections active in one screen as you switch to another screen. For example, if you are measuring harmonic 7 in the Volts Harmonic Screen and change function, the Tester continues measuring harmonic 7 in the Amps and Watts Harmonic screens.

### Waveform Screen Mode

Volts, Amps, and Watts Waveform screens use (Figure 10) a common format to present information about the measurement inputs. This format shows digital information on top and a waveform on the bottom. The waveform vertical scale limits usually change automatically (AUTO on) to accommodate the magnitude of the input. The horizontal scale represents 0 through 360 degrees (1 cycle) of the fundamental frequency.

With a waveform screen accessed, press  or  to activate the vertical cursor bar. Continue to press these keys to position the cursor along the horizontal degree scale. A second line of digital information defines magnitude and phase for the point where the cursor bar intersects the waveform.

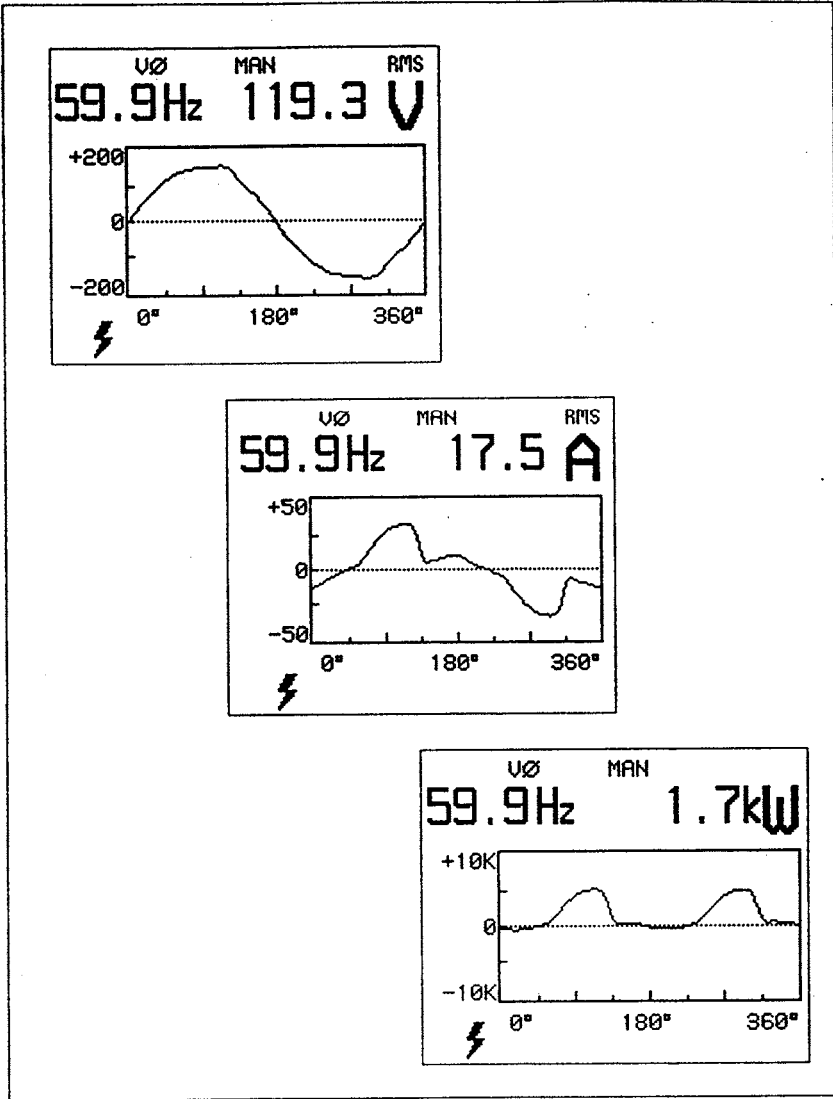

Figure 10. Waveform Screens

## Harmonics Screen Mode

The Harmonics Screen Mode (Figure 11) uses a set of two screens to present magnitude bars for all harmonics and digital information about the selected harmonic. Select a harmonic by pressing  $\leftarrow$  and  $\rightarrow$  to move the cursor along the bottom scale. DC, 1 (the fundamental frequency) and harmonics 2 through 15 appear on the first screen. Harmonics 16 through 31 appear on the second screen. Switch between harmonics screens by pressing  $\rightarrow$  when 15 is selected on the first screen or  $\leftarrow$  when 16 is selected on the second screen.

At the top of the screen, the percentage shown compares the selected cursor magnitude to either the fundamental or the total rms value (fundamental and all harmonics). The Tester also shows the magnitude of the cursor selection.

The harmonics overload screen (shown below) appears if either of the following conditions exists:

- There is no input on the phase reference channel. For example, there is no voltage input when  $V\emptyset$  is selected.
- There is no input on one of the measurement channels (volts or amps).

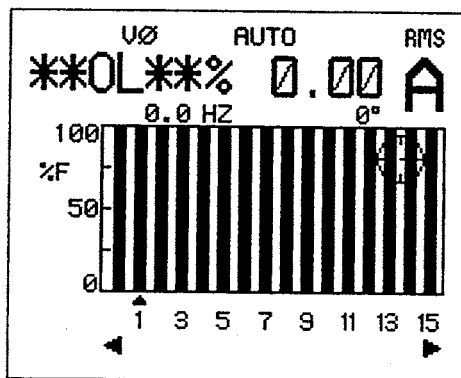

## Text Screen Mode

Text screens (Figure 12) present digital information for values measured or computed by the Tester. For Model 41 only, an arrow appears on the primary text screen, signifying that you can press  $\rightarrow$  to access a secondary text screen.

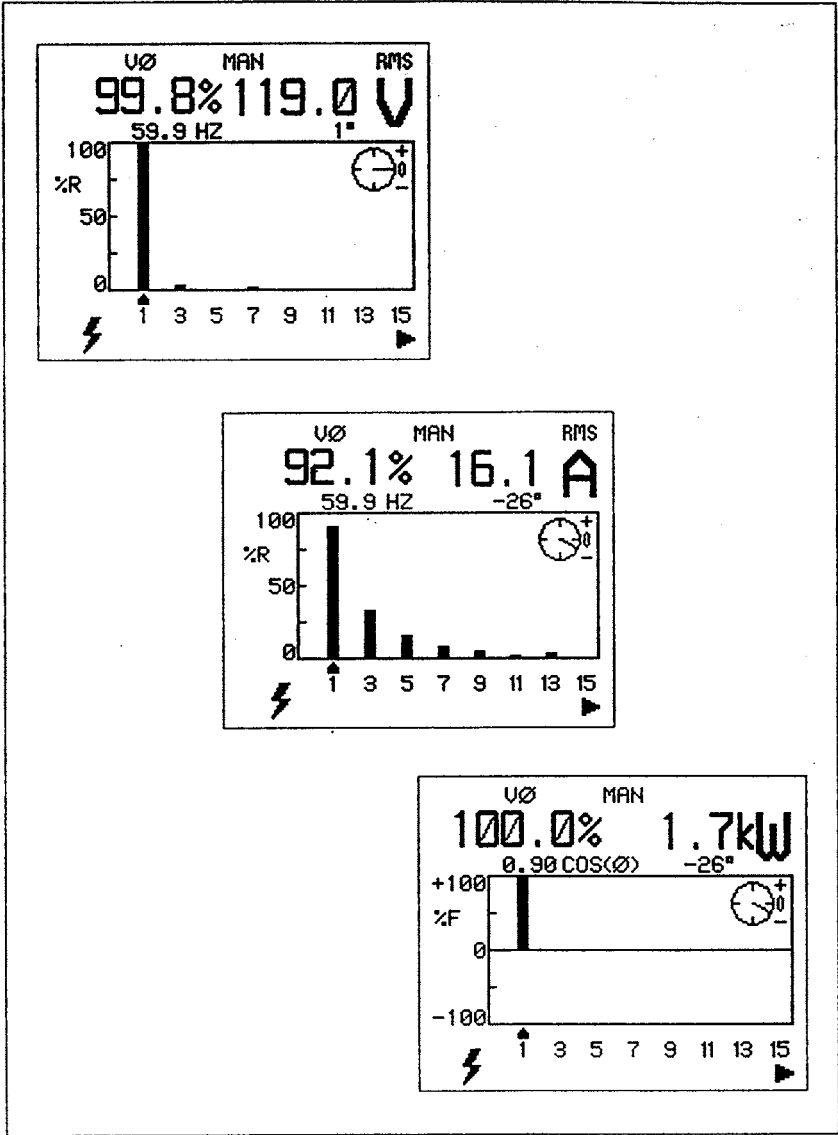

Figure 11. Harmonics Screens



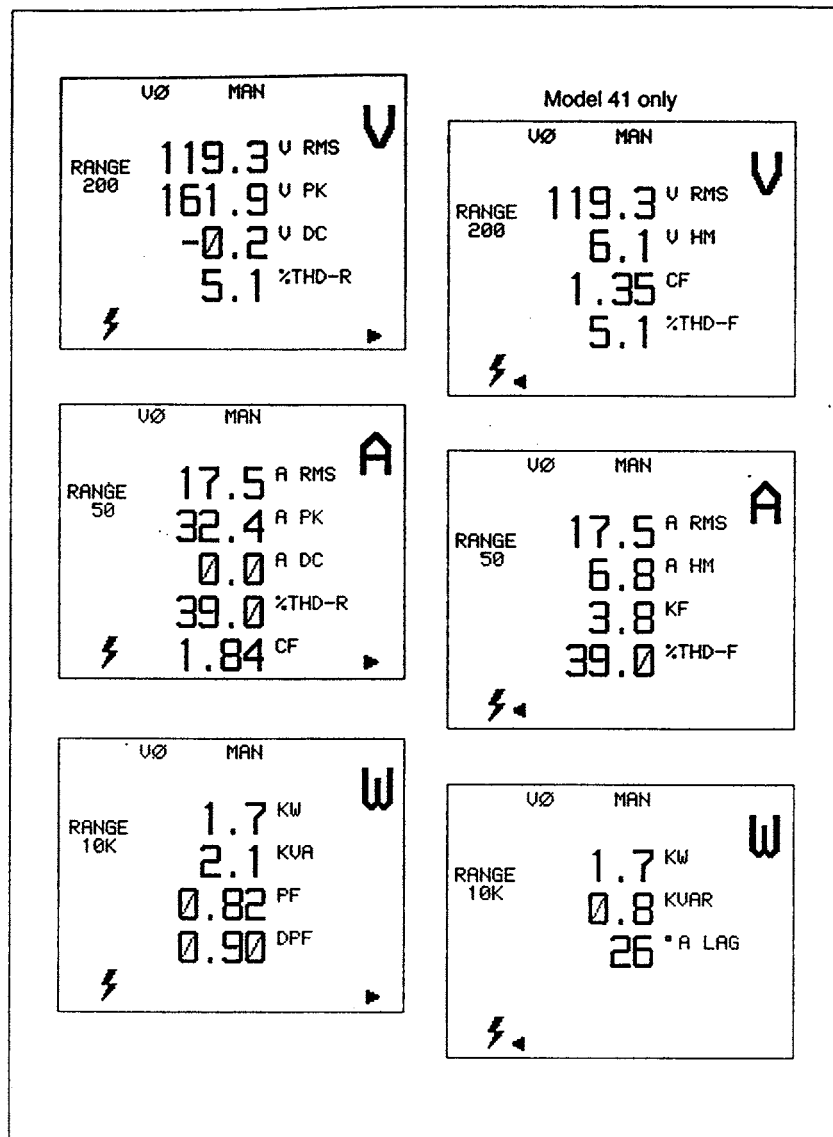



Figure 12. Text Screens





## VA CHECK SCREEN

Press  at any time to access the VA Check Screen, showing volts graphed against amps. Press  a second time to exit the VA Check Screen and return to your starting point.

With the VA Check Screen, the Tester displays 1 cycle of the fundamental frequency (current on the vertical scale, voltage on the horizontal scale). The resulting graph can appear as a straight line, a stepped line, an ellipsoid, or as some other pattern that you would normally expect to see on an oscilloscope with two input channels.

Use the VA Check Screen to show phase shift of the fundamental frequency and detect the existence and severity of nonlinearity caused by harmonics. Or, the VA Check Screen may just show that you have clamped the Current Probe in the wrong direction. Figure 13 shows some typical VA Check signatures.

When the Tester is set for autoranging (AUTO), ranges for the vertical and horizontal scales on the VA Check Screen are adjusted automatically to provide a meaningful display. If the Tester is set for manual ranging (MAN), both scales (ranges) are fixed; you may have to choose AUTO (press ) for 1 second) or select an appropriate manual range for either or both functions (press  briefly for each range change).

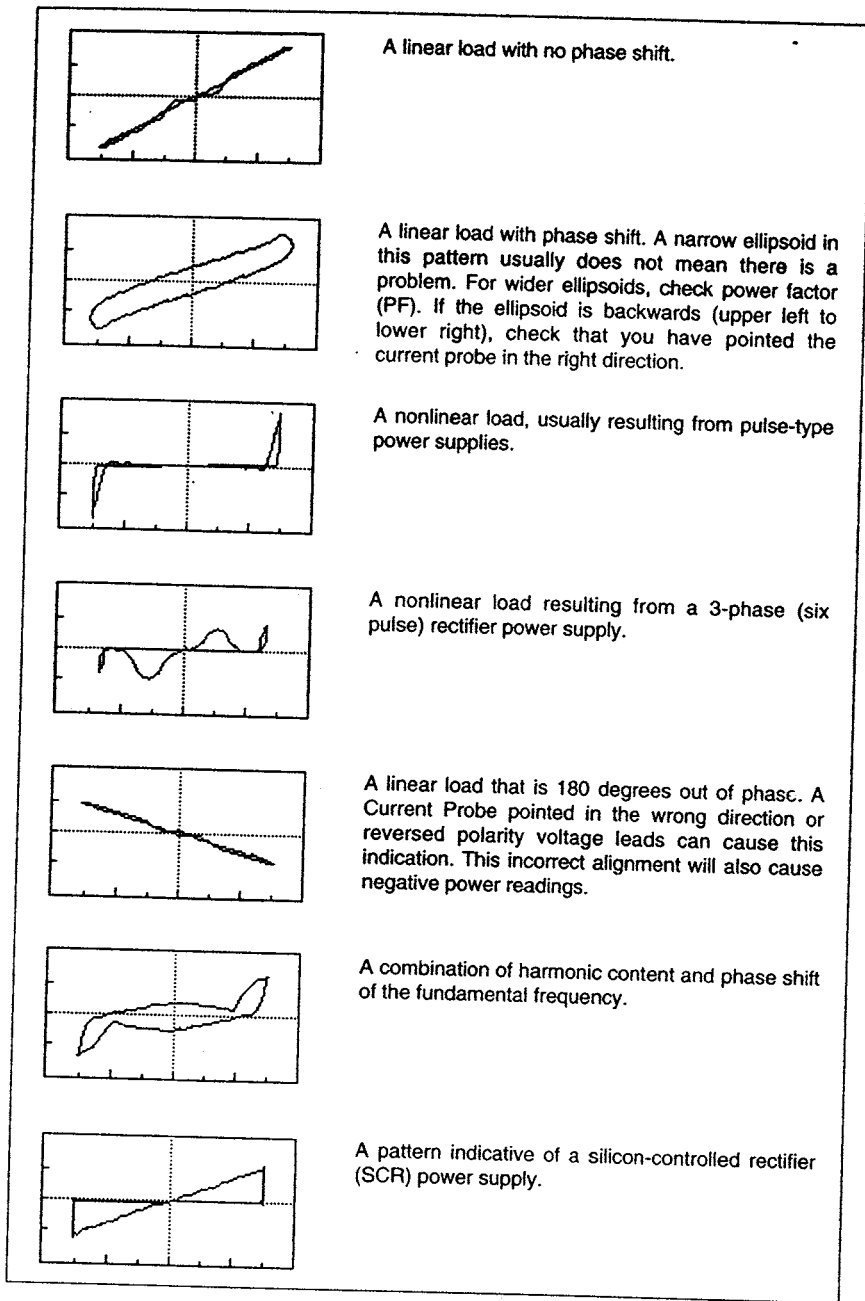







Figure 13. Typical  Signatures

Press this key to begin storing readings for all Measurement Functions. Then press  or  to cycle through the screens for the function presently selected. You can also switch between Measurement Functions while in Record. (See Figure 14 for an overview of possible Record screens.) For any function, the Tester displays screens in the following order:

- **NOW** The present readings. This screen always appears first when you start Record.
- **MAX** The maximum values measured since you started Record.
- **AVG** The averages of values measured since you started Record. (Average values stop updating after 48 hours of continuous Record operation.)
- **MIN** The minimum values measured since you started Record.

Press  a second time to exit Record, discarding all recorded values and returning to the previous measurement screen. The Tester begins storing a new set of values each time you start Record.

The Tester loses recorded values if the batteries discharge sufficiently. If  comes on during Record, write down any values of interest. (You have ample time to do this with alkaline batteries. NiCad batteries discharge much more rapidly once  comes on.) Changing the battery erases the Record memory.

You can access 12 different Record screens: NOW, MAX, AVG, and MIN for Volts, Amps, and Watts Measurement Functions. Figure 14 presents an overview of the Record measurements and computations available by function.

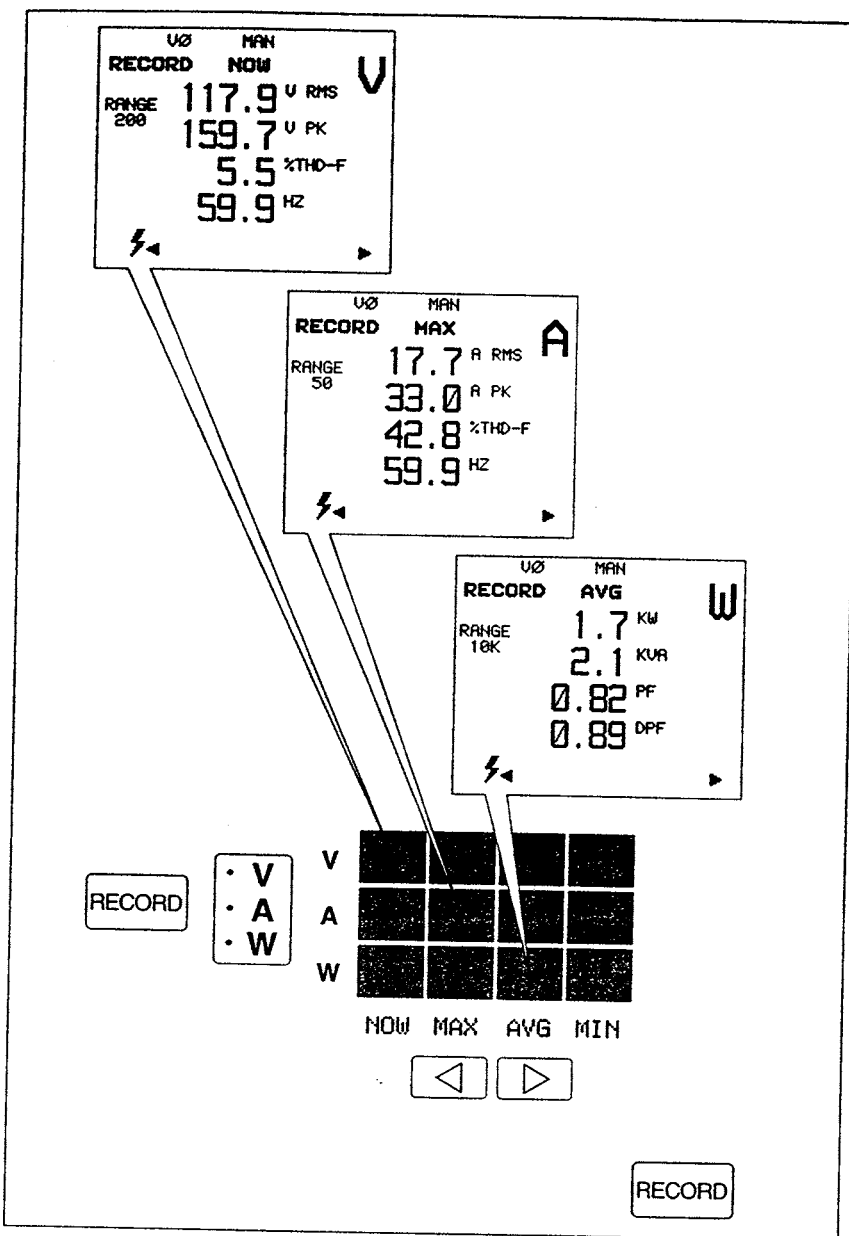



Figure 14. Record Screens

HOLD  
ENTER







## POWER-UP CONFIGURATION

The Tester has two types of configurations: standard and power-up. The standard configuration, which is programmed into the Tester and can always be retrieved, includes the following settings:

- FCN V Volts Function selected.
- DISP: WAVE Waveform Screen Mode selected.
- THD %F Total Harmonic Distortion computed as percentage of the fundamental frequency.
- CLAMP 80I-500S The 80i-500s Current Probe is selected. Other specifies any current probe other than the 80i-500s. The Tester has been calibrated to provide either compensation for the 80i-500s or a flat response for other probes.
-  REF V Voltage Phase Reference selected.

For Model 41, KBAUD 9.6 is the standard configuration for Send, and EPSON is the standard configuration for Print. The Tester always selects autoranging at power-up.

The power-up configuration, which is initially the same as the standard configuration, can be changed by making entries from the Configuration Screen. The Tester sets up to the power-up configuration each time it is turned on. You can change the power-up configuration using the following procedure:

1. Press  while pressing  to turn the Tester on. The appropriate Configuration Screen (Model 40 or 41 - see Figure 15) appears.
2. Press  and  to highlight different items on the same line. Press  to select the currently highlighted item and proceed to the next line.

3. To exit the screen, press **HOLD ENTER** to select a highlighted item on the last line and store all selections you have made during this configuration session. The Tester begins normal operation using these selections. The Tester also automatically sets up to these selections at the next power-up.

To exit the screen without making changes, press **HOLD ENTER** to cycle through all selection lines.

4. To restore the standard configuration, press **RECORD** as you press **0** on. (On Model 41, this action also clears waveform memory.)

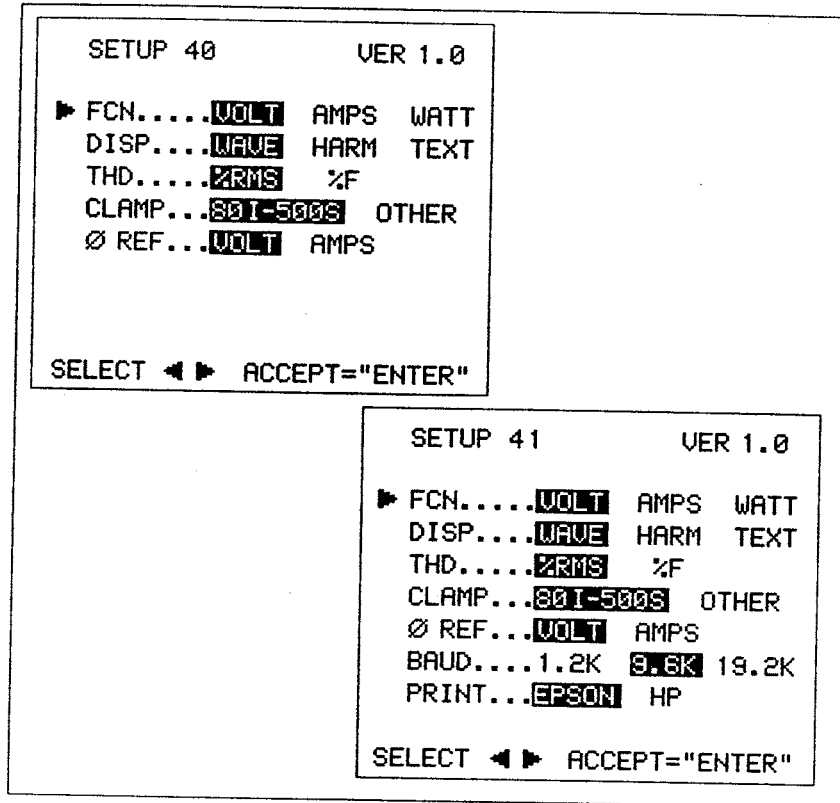

Figure 15. Configuration Screens

Model 41 allows you to store a maximum of eight sets of waveforms (and associated data) for volts and amps. You can recall data that you have collected on site for later viewing and analysis. (If you store multiple waveforms in this manner, you will probably want to keep a written record identifying the waveforms by number.)

The Tester stores all digital data for the test point; you can recreate all related waveform, harmonic, and text screen information when you recall the waveform.

The Tester stores waveforms in nonvolatile memory. A low battery condition or a battery change does not jeopardize the stored waveforms.

Referring to Figure 16, use the following procedure to store and recall measurements:

1. Press **MEMORY** to access the Waveform Storage Screen. The Tester freezes the existing waveform and shows the screen in Figure 16.
2. Press **◀** or **▶** to box the desired operation (RECALL, STORE, or CLEAR). Then press **HOLD ENTER**.
3. Select 1 of the 8 memory locations by pressing **◀** or **▶** to box 1 through 8. An underscore appears below a filled memory location.

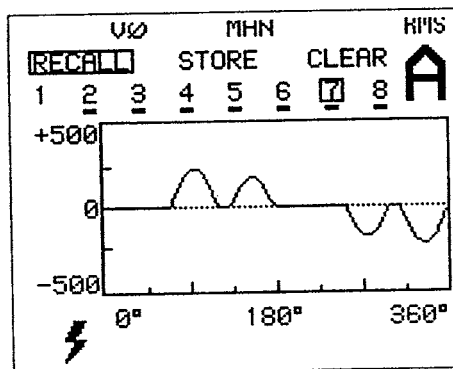

Figure 16. Memory Screen



4. STORE a waveform set (and associated data) into the boxed memory location by pressing **HOLD ENTER**. If the location was empty, an underscore now appears below the memory location number. If the underscore already existed, STORE overwrites the old waveform.

RECALL the selected memory location to view the contents directly by pressing **HOLD ENTER**.

CLEAR the selected memory location (waveform and associated data) from the boxed memory location by pressing **HOLD ENTER**. You can now continue selecting (press **◀** or **▶**) and clearing (press **HOLD ENTER**).

5. Exit the Waveform Storage Screen at any time by pressing **MEMORY** again. The Tester freezes the waveform last seen on the Waveform Storage Screen. If you do not wish to view or analyze this screen any further, press **HOLD ENTER**; the Tester resumes normal operation. If the frozen waveform is the result of a RECALL, you can access various representations and computations about the waveform by selecting different Measurement Function and Screen Mode combinations. You can also send the associated data to a PC or a printer.

#### NOTE

*You can clear all memory locations by holding **MEMORY** pressed while you press **0** on.*

## COMMUNICATIONS

Model 41 communicates with a PC or printer through an isolated RS-232 port. A 9-pin interface cable, 9-pin to 25-pin adapter, and 25-pin to 25-pin adapter allow for a variety of connections. See Figure 17. The Tester outputs data through the RS-232 port when you press  or  or when you send a command from the PC.

Using the Configuration Screen, you can set 1.2, 9.6, or 19.2 KBAUD. Other parameters are fixed as follows: 1 start bit, 8 data bits, 1 stop bit, and no parity.

### PRINTING (Model 41)

Pressing  sends data for the present screen to a printer. Printer type compatibility can be selected on the Configuration Screen as Epson FX or HP ThinkJet.

The Tester displays PRNT and the following message appears:

```
* PRINTING *  
PRESS ANY KEY TO STOP
```

Press any key to abort printing; all keys then return to their normal functions.

### SENDING TO A PC (Model 41)

Press  to start outputting calculated results to the PC. If you press  when Hold is active, Model 41 stops outputting after it has sent a single set of calculated results. At 9600 baud, the Tester requires approximately 1.2 seconds to output a typical set of calculated values (1120 bytes).

#### NOTE

*Do not press  while printing or using FlukeView™ 41 software. In either case, pressing  disrupts communications.*

### Using PC Software With the Tester (Model 41)

FlukeView™41 software is provided with Model 41 and can be used in DOS or Windows. Refer to the operating instructions provided with the software.

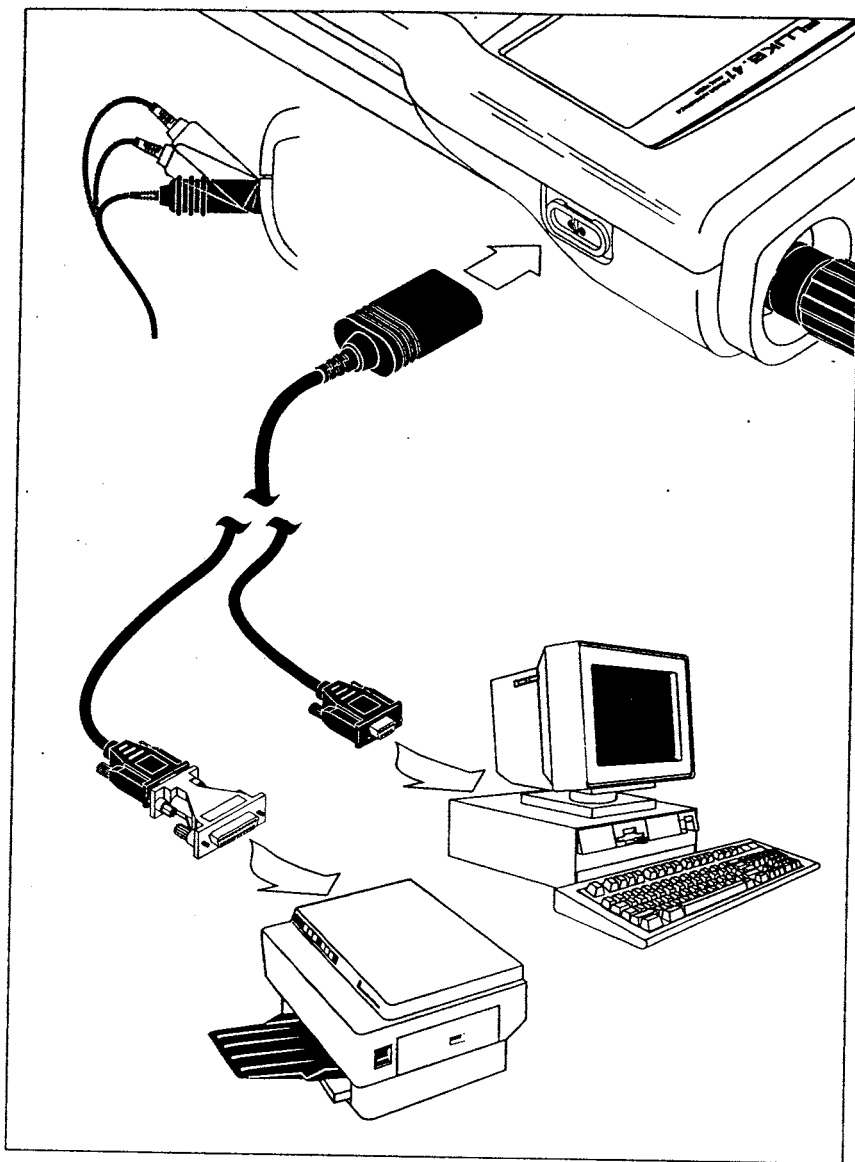
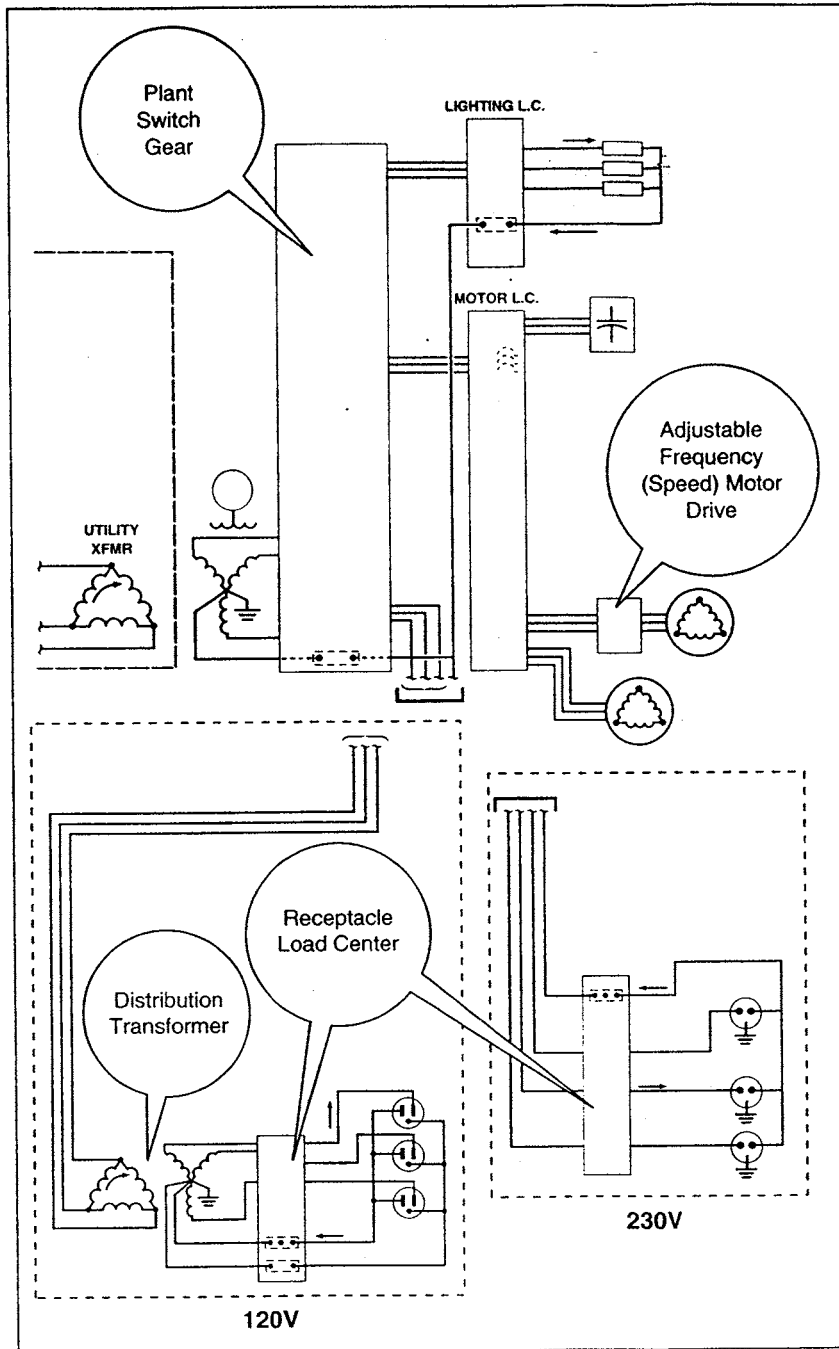

Figure 17. Serial Communications (Model 41)

# APPLICATIONS



### Plant Switch Gear (Service Entrance)

Measure current, load balance, total harmonic distortion. Refer to Figure 18.  
Press  $\cdot V \emptyset$  /  $\cdot A \text{ REF}$  to select current ( $A \emptyset$ ) for the display phase reference.

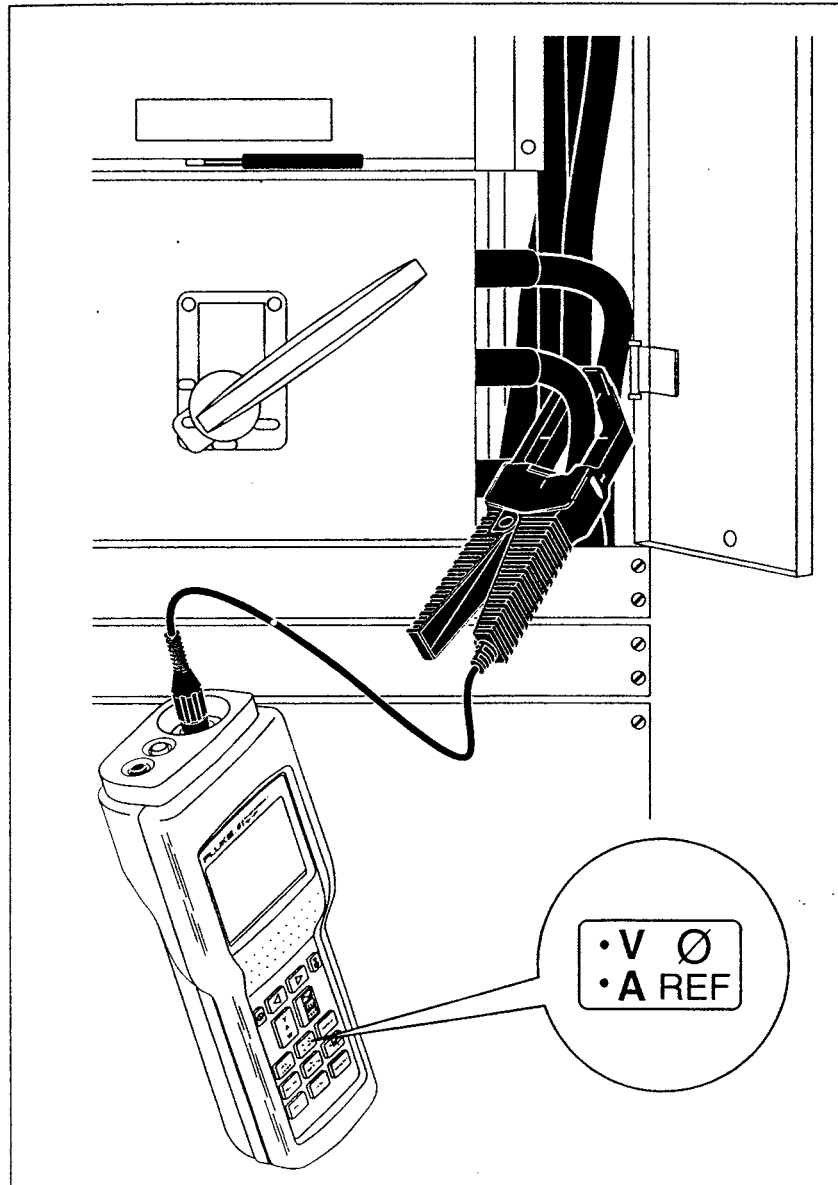

Figure 18. Plant Switch Gear

## Electronic Equipment Load Center

Measure for excessive current (tripping of circuit breakers) and other general measurement uses such as level of current flow in each circuit. Measure balance between phases, neutral current and frequency, harmonic distortion. Refer to Figure 20.

Measure input current, crest factor, and harmonics for PC, Copier, Printer, and Single Phase UPS. Most electronic equipment loads are nonlinear due to their use of switching-type power supplies.

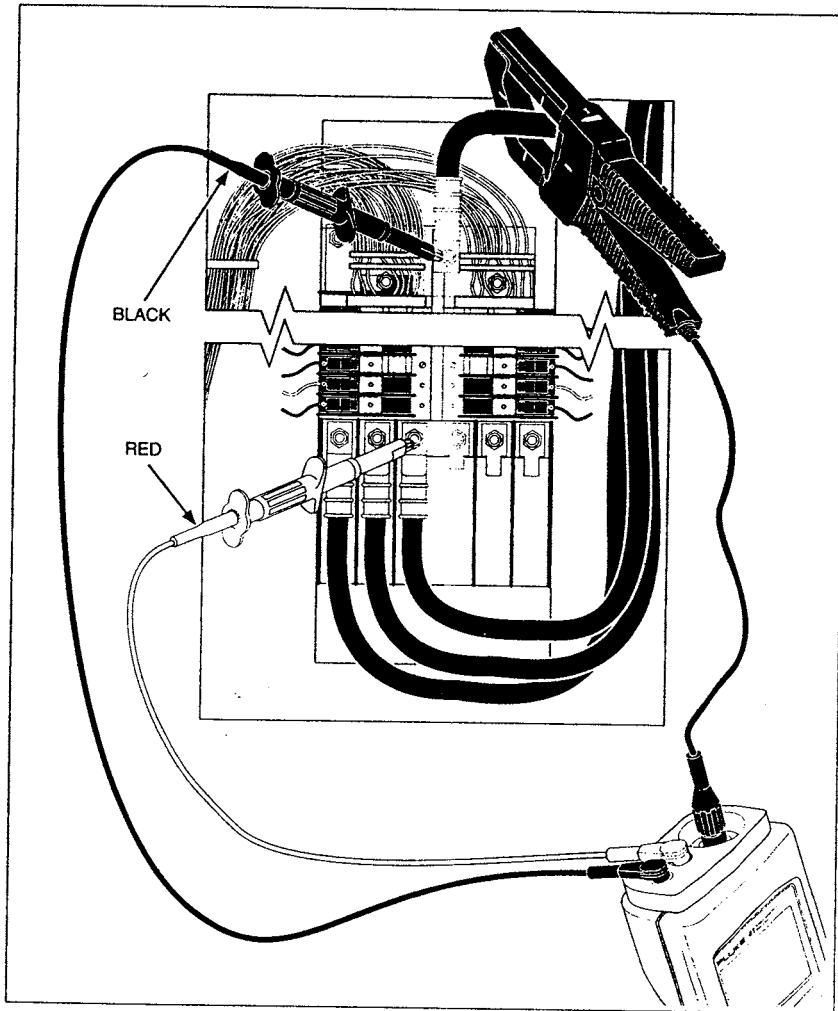

Figure 20. Receptacle Load Center

## Generator Set

Measure for excessive current, proper frequency (adjust generator speed), and other general uses. Refer to Figure 21. (Small generator shown.)

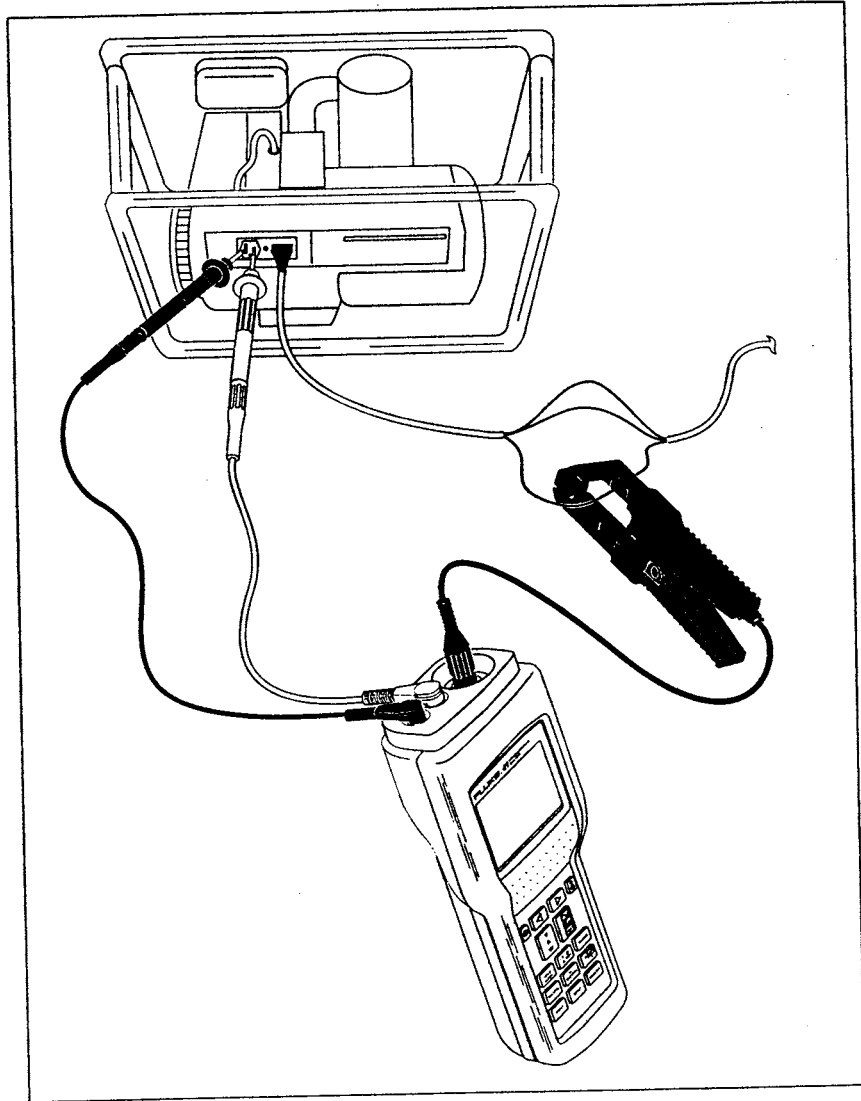

Figure 21. Generator Set

## Adjustable Frequency (Speed) Motor Drive

Measure input and output frequency and input and output current. Refer to Figure 22. The Tester measures the output current frequency of the drive. (Output current provides the most stable frequency measurement.) Input power and harmonic currents can also be measured.

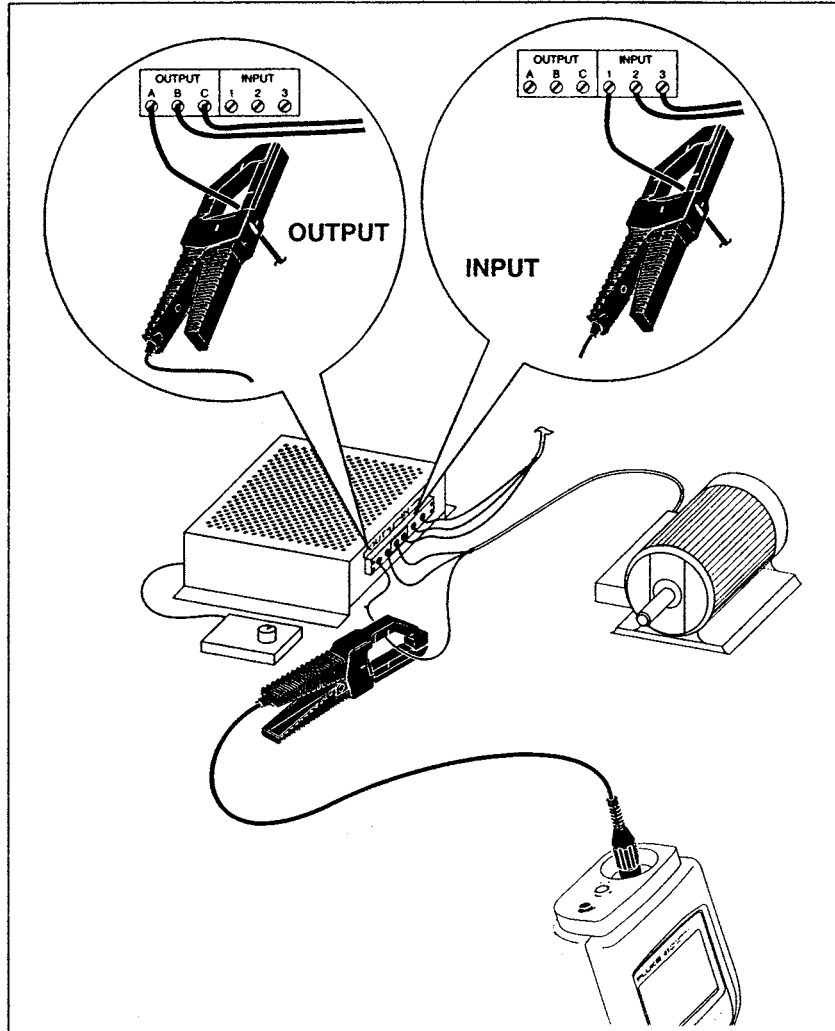

Figure 22. Adjustable Frequency Motor Drive



## USER MAINTENANCE

### Cleaning

Clean your Tester with a damp cloth and a mild detergent. Do not use abrasives, solvents, or alcohol.

### Fuse Replacement

Since the Tester uses electronically protected inputs, no fuses are required.

### Battery Replacement



#### WARNING

**TO AVOID ELECTRICAL SHOCK, DISCONNECT THE VOLTAGE TEST LEADS AND THE CURRENT PROBE BEFORE REPLACING THE BATTERIES.**

**THE TESTER MUST BE DISCONNECTED FROM ALL SOURCES BEFORE IT IS OPENED FOR ANY ADJUSTMENT, BATTERY REPLACEMENT, MAINTENANCE, OR REPAIR.**

The Tester uses four alkaline C cells (supplied). You can also use four rechargeable NiCad batteries; you must supply your own rechargeable batteries. (The Tester does not provide for internal recharging.)

Referring to Figure 23, use the following procedure to replace the batteries:

1. Press  off.
2. Disconnect the voltage test leads and the Current Probe at the test points (first) and at the Tester (second).
3. Place the Tester face down on a nonabrasive surface. Loosen the two screws with a flat-blade screwdriver.

4. Lift the battery access lid away from the Tester.
5. Replace the C cells (alkaline or recharged NiCad) as shown in Figure 23. Observe the battery polarity shown in the battery compartment.
6. Secure the battery access lid back in position with the two screws.

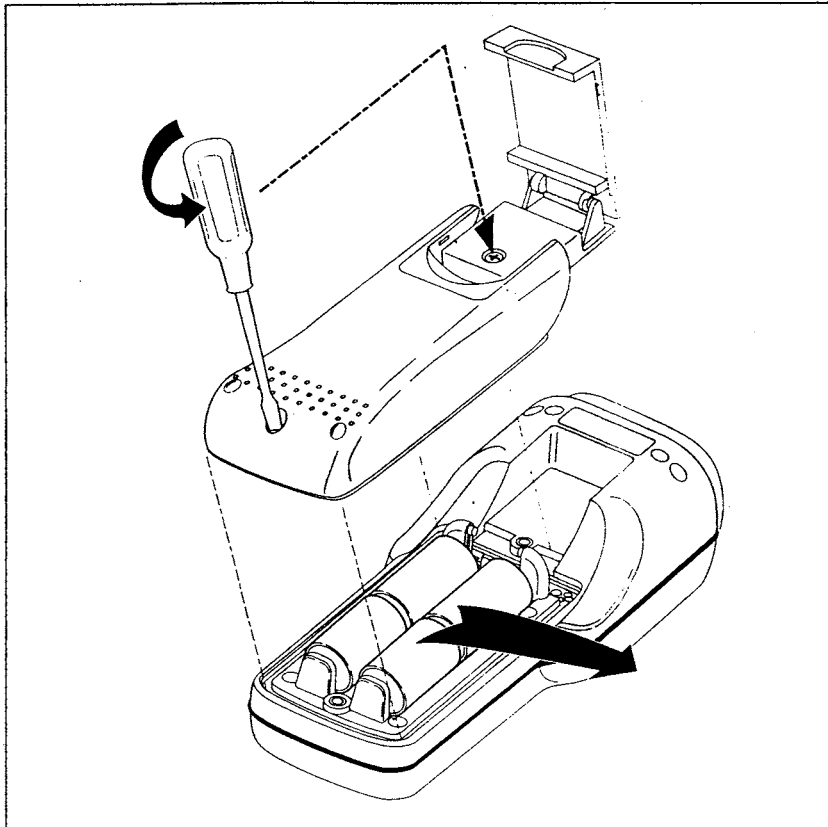

Figure 23. Battery Replacement

## Operational Test

Use any of the applications shown in this manual to verify volts, amps, and watts measurability. For a full operational test, refer to the Service Manual (P/N 942826).

### If Your Tester Does Not Work

If your Tester does not work, make the following basic checks:

- Examine the case for physical damage. If you detect damage, contact a Fluke Service Center. (Refer to the list of service centers near the end of this manual.)
- Are you testing a live circuit? Test on a known-live circuit.
- Check the batteries, test leads, and Current Probe. If necessary, replace any of these items.
- Review applicable parts of this manual to make sure you are operating the Tester correctly.

If the Tester still does not work, pack it securely and forward it, postage paid, to the nearest Service Center. Include a description of the problem. Fluke assumes no responsibility for damage in transit.

At its option, Fluke will repair or replace a Tester under warranty. The Tester will be returned at no charge. Refer to the Warranty Card for warranty terms. If the warranty has lapsed, Fluke will repair and return the Tester for a fixed fee. Contact your nearest Service Center for information and prices. (Refer to the list of service centers near the end of this manual.)

## ACCESSORIES AND REPLACEMENT PARTS

### Service Manual

Order Part Number 942826.

### Accessories

For a list of standard accessories included with the Tester, see "Unpacking" earlier in this manual. Optional accessories are as follows:



- 80i-1000s AC Current Probe
- C41s Soft Carrying Case

### Replacement Parts

Parts that can be replaced by the user are as follows:

- Batteries (each) PN 423582
- Battery Door (with screws) PN 936807
- Bail PN 936810

Refer to the Service Manual for a complete list of replaceable parts.

  Use only specified replacement parts.

## SPECIFICATIONS

### MINIMUM INPUT LEVELS

5V rms (using V $\emptyset$  reference)  
or 1A rms (using A $\emptyset$  reference)

### VOLTS MEASUREMENTS (TRUE RMS)

Input Range: 0.0V to 600V rms (ac + dc)  
0.0V to +/-933V peak

Basic Accuracy (Fundamental 5 - 65 Hz, dc)  
rms: +/- (0.5% + 2 digits)  
peak, dc: +/- (2% + 3 digits)

Input Impedance: 1 M $\Omega$ , balanced

Crest Factor: > 3.0 below 300V, 1.56 @ 600V

### AMPS MEASUREMENTS (TRUE RMS)

#### (1 mV/A) Isolated Input

Input Range: 1.00 mV (A) to 1000 mV rms (A) (ac + dc)  
1.0 mV (A) to +/- 2000 mV (A) peak

Basic Accuracy (Fundamental 5 Hz - 65 Hz, dc)  
rms: +/- (0.5% + 3 digits) + probe specs.  
peak, dc: +/- (2% + 4 digits) + probe specs.

Input Impedance: 1 M $\Omega$  || 47 pF

Crest Factor: > 3.0 below 600 mV, 2.0 @ 1000 mV

### WATTS MEASUREMENTS (VOLT-AMPS)

#### (1 mV/A) Isolated Input

Range: 0 W (VA) to 600 kW (kVA) average  
0 W (VA) to 2000 kW (kVA) peak

Accuracy (Fundamental 5 Hz - 65 Hz, dc)  
Active (average) W (VA): +/- (1% + 4 digits) + probe specs

**HARMONICS MEASUREMENT ACCURACY (CURSOR DATA)  
(Using Smooth  $\Delta$ -20)**

**Volts:**

Fundamental to 13th Harmonic

Volts:  $\pm$  (2% + 2 digits)

Phase:  $\pm$  2 degrees (harmonic > 5%)

13th to 31st Harmonic

Volts: 13th ( $\pm$  (2% + 2 digits)) ----- 31st ( $\pm$  (8% + 2 digits))

Phase:  $\pm$  10 degrees (harmonic > 5%)

**Amps and Watts**

Fundamental to 13th Harmonic

Amps or Watts:  $\pm$  (3% + 3 digits) + probe specs

Phase:  $\pm$  2 degrees + probe specs (harmonic > 5%)

13th to 31st Harmonic

Amps or Watts: 13th ( $\pm$  (3% + 3 digits) + probe specs) ---

--- 31st ( $\pm$  (8% + 3 digits) + probe specs)

Phase:  $\pm$  10 degrees + probe specs (harmonic > 5%)

**FREQUENCY MEASUREMENT ACCURACY (Fundamental, 5.0 Hz - 99.9 Hz)**

5.0 Hz - 99.9 Hz:  $\pm$  0.3 Hz

**OTHER MEASUREMENT SPECIFICATIONS**

Input Bandwidth: (-0.5 dB)	DC, 5 Hz to 2.1 kHz
Crest Factor (CF) Range:	1.00 to 5.00
Power Factor (PF):	0.00 to 1.00
Displacement Power Factor (DPF):	0.00 to 1.00
Phase Measurement Range:	-179 to 180 degrees
K-Factor (KF) Range (Model 41):	1.00 to 30.00

## GENERAL SPECIFICATIONS

Size: 9.2 x 3.9 x 2.5 inches (234 x 100 x 64 mm)

Weight: 2.0 lbs (1 kg)

### Input Connectors:

Voltage: 2 shrouded banana jacks (4 mm)  
Current Probe: 1 shrouded BNC jack

### Battery:

Type: 4 Alkaline "C" Cells ANSI/NEDA-14A, IEC-LR14 (supplied)  
Operating Time: 24 Hours, minimum (continuous, without backlight)

### Alternate Battery:

4 NiCad Cells, customer supplied and externally charged. The tester prevents battery reversal by turning itself off if battery voltage drops below 4.0V dc.

### Temperature:

Operating: 0 to 50 °C (32 to 122°F)  
Storage: -20 to 60°C (-4 to 140°F)

### Temperature Coefficient:

0.1 x Specified Accuracy per degree C  
(0 to 18 degrees C, 28 to 50 degrees C)

### Humidity (non-condensing):

Operating:	0 - 30°C:	90%
	30 - 40°C:	75%
	40 - 50°C:	45%
Storage:		90%

### Altitude:

Operating: 10,000 feet (3 km)  
Storage: 40,000 feet (12 km)

Shock & Vibration: per MIL-T-28800, class 3, sinusoidal, non-operating

### Electro-Magnetic Interference:

RF Emissions: EN 50081-1 Commercial Limits,  
FCC Part 15 Class B,  
VFG 243-1991  
RF Susceptibility: EN 50082-2 Industrial Limits

Spray Proof and Dust Proof Case: per IEC 529, Section 3;  
IP 52 Dust-Protected, Drip Proof

## DISPLAY

Type: Super Twisted Liquid Crystal  
Size: 3.0 inch diagonal (76 mm)  
Resolution: 160 W x 128 H pixels  
Contrast: User adjustable  
Backlight: Yellow-green LED

## SAFETY

Designed for 600V measurements on industrial power distribution circuits.

 Overload Protection:  
Voltage or Current Probe Input: 600V, maximum  
Surge Protection: 6 kV per IEC 1010-1  
Maximum Voltage Isolation to Earth: 600V from any terminal

Protection Levels:  
IEC 1010-1, Pollution Degree 2, Installation  
Category III, Material Group II, 600V

Protection Class:  
Protection Class II as described in IEC 1010-1,  
Annex H (Double or Reinforced Insulation).

## WAVEFORM MEMORY (Model 41 only)

Eight non-volatile memories store 2048 sampled points of waveform data for both Voltage and Current inputs for later recall or sending to a computer.

## EIA-232-E (RS-232) INTERFACE (Model 41 only)

Optically-Isolated, 1.2, 9.6, or 19.2 kbaud rate. Display "Picture"  
Printer output in either Epson FX-80 or HP Thinkjet format. Waveform,  
Data, Picture formats may be remotely accessed. Remote Trigger  
function.