

Fluke Networks DTX-1800 DTX-GFM Specs

Provided by www.AAATesters.com



DTX-MFM/GFM/SFM

Fiber Modules

Users Manual

PN 2142235

April 2004, Rev. 1 11/04

© 2004 Fluke Corporation. All rights reserved. Printed in USA.
All product names are trademarks of their respective companies.

LIMITED WARRANTY AND LIMITATION OF LIABILITY

Each Fluke Networks product is warranted to be free from defects in material and workmanship under normal use and service. The warranty period for the mainframe is one year and begins on the date of purchase. Parts, accessories, product repairs and services are warranted for 90 days, unless otherwise stated. Ni-Cad, Ni-MH and Li-Ion batteries, cables or other peripherals are all considered parts or accessories. The warranty extends only to the original buyer or end user customer of a Fluke Networks authorized reseller, and does not apply to any product which, in Fluke Networks' opinion, has been misused, abused, altered, neglected, contaminated, or damaged by accident or abnormal conditions of operation or handling. Fluke Networks warrants that software will operate substantially in accordance with its functional specifications for 90 days and that it has been properly recorded on non-defective media. Fluke Networks does not warrant that software will be error free or operate without interruption.

Fluke Networks authorized resellers shall extend this warranty on new and unused products to end-user customers only but have no authority to extend a greater or different warranty on behalf of Fluke Networks. Warranty support is available only if product is purchased through a Fluke Networks authorized sales outlet or Buyer has paid the applicable international price. Fluke Networks reserves the right to invoice Buyer for importation costs of repair/replacement parts when product purchased in one country is submitted for repair in another country.

Fluke Networks' warranty obligation is limited, at Fluke Networks' option, to refund of the purchase price, free of charge repair, or replacement of a defective product which is returned to a Fluke Networks authorized service center within the warranty period.

To obtain warranty service, contact your nearest Fluke Networks authorized service center to obtain return authorization information, then send the product to that service center, with a description of the difficulty, postage and insurance prepaid (FOB Destination). Fluke Networks assumes no risk for damage in transit. Following warranty repair, the product will be returned to Buyer, transportation prepaid (FOB Destination). If Fluke Networks determines that failure was caused by neglect, misuse, contamination, alteration, accident or abnormal condition of operation or handling, or normal wear and tear of mechanical components, Fluke Networks will provide an estimate of repair costs and obtain authorization before commencing the work. Following repair, the product will be returned to the Buyer transportation prepaid and the Buyer will be billed for the repair and return transportation charges (FOB Shipping Point).

THIS WARRANTY IS BUYER'S SOLE AND EXCLUSIVE REMEDY AND IS IN LIEU OF ALL OTHER WARRANTIES, EXPRESS OR IMPLIED, INCLUDING BUT NOT LIMITED TO ANY IMPLIED WARRANTY OF MERCHANTABILITY OR FITNESS FOR A PARTICULAR PURPOSE. FLUKE NETWORKS SHALL NOT BE LIABLE FOR ANY SPECIAL, INDIRECT, INCIDENTAL OR CONSEQUENTIAL DAMAGES OR LOSSES, INCLUDING LOSS OF DATA, ARISING FROM ANY CAUSE OR THEORY.

Since some countries or states do not allow limitation of the term of an implied warranty, or exclusion or limitation of incidental or consequential damages, the limitations and exclusions of this warranty may not apply to every buyer. If any provision of this Warranty is held invalid or unenforceable by a court or other decision-maker of competent jurisdiction, such holding will not affect the validity or enforceability of any other provision.

Table of Contents

Title	Page
Overview of Features	1
Registration	1
Contacting Fluke Networks	2
Accessing the Technical Reference Handbook	2
Additional Resources for Cable Testing Information	2
Unpacking	3
DTX-MFM Multimode Fiber Modules	3
DTX-GFM Multimode Fiber Modules	3
DTX-SFM Singlemode Fiber Modules	4
Safety Information	4
Getting Acquainted	6
Installing and Removing Fiber Modules	6
Physical Features	7
Essentials for Reliable Fiber Test Results	8
Cleaning Connectors and Adapters	8

About Setting the Reference	9
Using Mandrels for Testing Multimode Fiber	10
Testing Your Patch Cords	11
Fiber Test Settings	12
Certifying Fiber Cabling	17
Autotest in Smart Remote Mode	17
Autotest in Loopback Mode	22
Autotest in Far End Source Mode	28
Using the Visual Fault Locator	33
Monitoring Optical Power	36
Options and Accessories	39
Maintenance	42
Replacing Fiber Patch Cords	42
Using the Smart Remote with an OptiFiber™ Certifying OTDR	42
Certification, Compliance, and Regulatory Information	43
Appendix A: Test Method Reference Tables	A-1

Index

List of Figures

Figure	Title	Page
1.	Installing and Removing Fiber Modules	6
2.	Fiber Module Features	7
3.	Wrapping a Patch Cord Around a Mandrel	11
4.	Example of How to Determine the Number of Adapters Setting	14
5.	Equipment for Testing in Smart Remote Mode	17
6.	Smart Remote Mode Reference Connections (Modified Method B).....	19
7.	Smart Remote Mode Test Connections (Modified Method B).....	21
8.	Equipment for Testing in Loopback Mode	23
9.	Loopback Mode Reference Connections (Modified Method B)	25
10.	Loopback Mode Test Connections (Modified Method B)	27
11.	Equipment for Testing in Far End Source Mode	28
12.	Far End Source Mode Reference Connections (Modified Method B).....	31
13.	Far End Source Mode Test Connections (Modified Method B).....	32
14.	Equipment for Using the Visual Fault Locator	33
15.	Using the Visual Fault Locator.....	35
16.	Equipment for Monitoring Optical Power.....	36
17.	Connections for Monitoring Optical Power	38

DTX-MFM/GFM/SFM Fiber Modules

Overview of Features

The DTX-MFM, DTX-GFM, and DTX-SFM fiber modules are used with a DTX Series CableAnalyzer to test and certify fiber optic cabling installations. The fiber modules offer the following functions and features:

- Measures optical power loss and length on dual-fiber cabling. The DTX-MFM tests multimode cabling at 850 nm and 1300 nm. The DTX-SFM tests singlemode cabling at 1310 nm and 1550 nm. The DTX-GFM features a VCSEL LED for testing multimode cabling at 850 nm and 1310 nm for Gigabit Ethernet applications.
- Each module transmits both wavelengths (850 nm and 1300 nm, 850 nm and 1310 nm, or 1310 nm and 1550 nm).
- Provides pass/fail results based on industry-standard limits.

- Visual fault locator helps you locate breaks, bad splices, bends, and check fiber continuity and polarity.
- FindFiber™ function helps you identify and verify fiber connections.

Registration

Registering your product with Fluke Networks gives you access to valuable information on product updates, troubleshooting tips, and other support services. To register, fill out the online registration form on the Fluke Networks website at www.flukenetworks.com/registration.

Contacting Fluke Networks

Note

If you contact Fluke Networks about your tester, have the tester's software and hardware version numbers available if possible.



www.flukenetworks.com



support@flukenetworks.com



+1-425-446-4519

- Australia: 61 (2) 8850-3333 or 61 (3) 9329 0244
- Beijing: 86 (10) 6512-3435
- Brazil: 11 3044 1277
- Canada: 1-800-363-5853
- Europe: +44 1923 281 300
- Hong Kong: 852 2721-3228
- Japan: +81-3-3434-0181
- Korea: 82 2 539-6311
- Singapore: +65-6738-5655
- Taiwan: (886) 2-227-83199
- USA: 1-800-283-5853

Visit our website for a complete list of phone numbers.

Accessing the Technical Reference Handbook

The *DTX Series CableAnalyzer Technical Reference Handbook* provides additional information on the tester and the fiber modules. The handbook is available on the DTX CableAnalyzer Product CD included with your modules and on the DTX CableAnalyzer product page on the Fluke Networks website.

Additional Resources for Cable Testing Information

The Fluke Networks Knowledge Base provides answers to common questions about Fluke Networks products, along with articles on cable testing techniques and technology. To access the Knowledge Base, log on to www.flukenetworks.com, then click **knowledge base** at the top of the page.

The website cabletesting.com provides articles on testing, documentation, and standards, answers to common questions about cable testing, a glossary, and other reference information.

Unpacking

The fiber modules come with the accessories listed below. If something is damaged or missing, contact the place of purchase immediately.

DTX-MFM Multimode Fiber Modules

- Two DTX-MFM Fiber Modules for testing at 850 nm and 1300 nm
- Two SC/SC adapters
- Four 62.5/125 μm multimode patch cords, 2 m, SC/SC
- Two 62.5/125 μm multimode patch cords, 0.3 m, SC/SC
- Two gray mandrels for 62.5 /125 μm fiber with 3 mm jackets
- *DTX-MFM/GFM/SFM Fiber Modules Users Manual*
- DTX CableAnalyzer Product CD
- LinkWare Software CD

DTX-GFM Multimode Fiber Modules

- Two DTX-GFM Fiber Modules for testing at 850 nm and 1310 nm (for Gigabit Ethernet applications)
- Two SC/SC adapters
- Four 50/125 μm multimode patch cords, 2 m, SC/SC
- Two 50/125 μm multimode patch cords, 0.3 m, SC/SC
- *DTX-MFM/GFM/SFM Fiber Modules Users Manual*
- DTX CableAnalyzer Product CD
- LinkWare Software CD

DTX-SFM Singlemode Fiber Modules

- Two DTX-SFM Fiber Modules for testing at 1310 nm and 1550 nm.
- Two SC/SC adapters
- Four 9/125 μm singlemode patch cords, 2 m, SC/SC
- Two 9/125 μm singlemode patch cords, 0.3 m, SC/SC
- *DTX-MFM/GFM/SFM Fiber Modules Users Manual*
- DTX CableAnalyzer Product CD
- LinkWare Software CD

Note

The patch cords provided are suitable for testing SC-terminated links. Other patch cords are required for other connector types or 50 /125 μm fiber. Many are available as accessories from Fluke Networks.

Safety Information

Warning

To avoid possible fire, electric shock, or personal injury read the safety information given in the *DTX Series CableAnalyzer Users Manual*.

Warning: Class 1 and Class 2 Laser Products

To avoid possible eye damage caused by hazardous radiation:

- Never look directly into optical connectors. Some sources produce invisible radiation that can permanently damage your eyes.
- Keep the fiber module's OUTPUT port covered with a dust cap or keep a patch cord attached. The OUTPUT port may be active even when a test is not in progress. Covering the port reduces the risk of accidental exposure to hazardous radiation.
- Never start a test or activate the OUTPUT port or VFL port without first connecting a fiber to the port you will use.

- Never look directly into the visual fault locator output. Momentary exposure to the locator's output will not damage your eyes; however, direct, long-term exposure is potentially hazardous.
- Do not use magnification to view the optical outputs without proper filtering.
- Use of controls, adjustments, or procedures not stated herein might result in hazardous radiation exposure.
- Use a Fluke Networks FiberInspector Video Microscope to periodically inspect the fiber module's OUTPUT connector for scratches and other damage.
- Do not use a video microscope to inspect the fiber module's INPUT connector. This connector has different dimensions than the OUTPUT connector, and may be damaged by a fiber inspection probe.

Caution

To avoid damaging the tester or cables under test, to avoid data loss, and to ensure maximum accuracy of test results:

- Leave the module bay covers in place when the fiber modules are not installed.
- Turn off the tester before attaching or removing modules.
- When using the fiber modules, use proper cleaning procedures to clean all fiber connectors before every use. Neglecting this step or using improper procedures can cause unreliable test results and may permanently damage the connectors.

Getting Acquainted

The following sections introduce the fiber modules' features.

Installing and Removing Fiber Modules

Figure 1 shows how to install and remove the fiber modules.

Caution

Leave the module bay covers in place when the fiber modules are not installed.

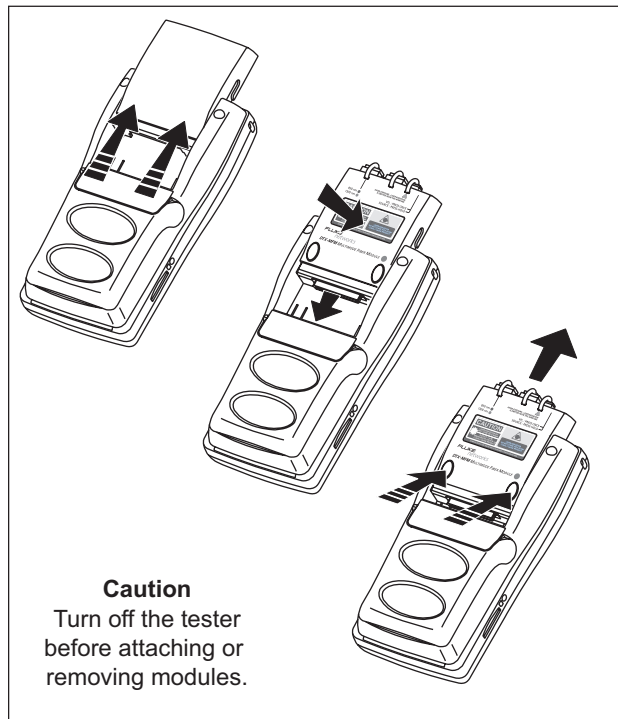
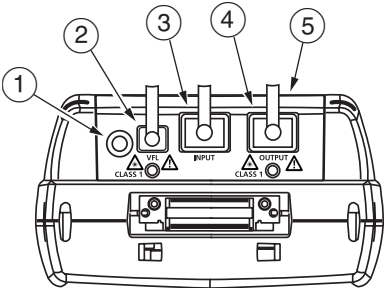

Figure 1. Installing and Removing Fiber Modules

Physical Features



amd64f.eps

Warning

Never look directly into optical output connectors (2 and 4). Some sources produce invisible radiation that can permanently damage your eyes.

- ① Button for activating the visual fault locator (②) and output port (④). See “Using the Visual Fault Locator” on page 33 and “Autotest in Far End Source Mode” on page 28.
- ② Universal fiber connector (with dust cap) for the visual fault locator output. The connector accepts 2.5 mm ferrules. The LED below the connector indicates the locator’s mode (continuous or blinking).
- ③ SC input connector with dust cap. Receives optical signals for loss, length, and power measurements.
- ④ SC output connector with dust cap. Transmits optical signals for loss and length measurements.
- ⑤ Laser safety label (shown at right).

The LED below the connector is red when the output is transmitting the module’s shorter wavelength, and green for the longer wavelength.

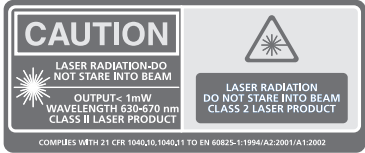

amd128i.eps

Figure 2. Fiber Module Features

Essentials for Reliable Fiber Test Results

To get reliable fiber test results, you must follow proper cleaning and referencing procedures and, in some cases, use mandrels during testing.

Cleaning Connectors and Adapters

Always clean and inspect fiber connectors before making connections. Use 99 %-pure isopropyl alcohol and optical-grade wipes or swabs to clean connectors as follows:

- Connector ends: Wipe the end of the ferrule with a swab or wipe lightly moistened with alcohol. Dry with a dry swab or wipe.

Note

Use a 2.5 mm foam swab for cleaning the tester's optical connectors.

- Bulkhead connectors: Dip the tip of a foam swab in alcohol; then touch the swab to a dry wipe. Touch a new, dry swab to the alcohol spot on the wipe. Push the swab into the connector; twist it around 3 to 5 times against the endface, then remove and dispose of the swab. Dry the connector with a dry swab by twisting it around in the connector 3 to 5 times.
- Inspect connectors with a fiber microscope, such as the Fluke Networks FiberInspector Video Microscope before making connections.

Periodically clean fiber adapters with a swab and alcohol. Dry adapters with a dry swab before use.

Always cover unused connectors with dust caps or plugs. Clean dust plugs periodically with a swab or wipe and alcohol.

About Setting the Reference

The reference serves as the baseline power level for loss measurements. Regular referencing helps account for minor variations in source power and connection integrity. Also, since the reference is the baseline for measurements, the losses of the patch cords and adapters used during referencing are excluded from test results.

Note

Turn on the tester and smart remote and let them sit for 5 minutes before setting the reference. Allow additional time if the modules have been stored above or below ambient temperature.

You should set the reference at these times:

- At the beginning of each day using the remote end setup (Figures 7 through 13) you will use that day.
- Anytime you reconnect a patch cord to the module's output or other source.

- Anytime the tester warns you that the reference is out of date.
- Anytime you see a negative loss measurement. (See the *Technical Reference Handbook* for more information.)

You must set the reference at these times:

- Anytime you change the fiber module in the tester or smart remote.
- Anytime you start using a different smart remote.
- Anytime you change the **Test Method** in Setup.
- Twenty-four hours after the reference was previously set.

Reference values should not change by more than a few tenths of a dB from day to day. Larger changes may indicate a problem with the patch cords or connections.

See the sections on Smart Remote, Loopback, and Far End Source modes for details on setting the reference for each mode.

Using Mandrels for Testing Multimode Fiber

You should use mandrels when testing multimode fiber with the DTX-MFM fiber modules. Mandrels can improve measurement repeatability and consistency. They also allow the use of LED light sources to certify 50 μm and 62.5 μm fiber links for current and planned high bit-rate applications, such as Gigabit Ethernet and 10 Gigabit Ethernet.

⚠ Caution

Do not use mandrels when testing with the DTX-GFM fiber modules.

The gray mandrels included with the DTX-MFM are compliant with TIA/EIA-568-B for 62.5 μm fiber with a 3 mm jacket. Mandrels for 50 μm fiber are available from Fluke Networks. Refer to the appropriate standard for mandrel requirements if you follow other standards. Table 1 shows a partial list of mandrel requirements for TIA and ISO standards.

Figure 3 shows how to wrap the fiber around a mandrel. Place mandrels on the tester's output fibers, as shown in Figures 6 through 13.

In the reference and test connection diagrams shown on the tester, mandrels are indicated by a loop in the fiber.

Table 1. TIA/EIA-568-B.1 and ISO/IEC TR 14763-3 Mandrel Requirements

Fiber core size	Standard	Wraps Around Mandrel	Mandrel Diameter for 250 μm Buffered Fiber	Mandrel Diameter for 3 mm (0.12 in) Jacketed Cable
50 μm	TIA/EIA-568-B.1 7.1	5	25 mm (1.0 in)	22 mm (0.9 in)
	ISO/IEC TR 14763-3 6.22	5	15 mm (0.6 in)	15 mm (0.6 in)
62.5 μm	TIA/EIA-568-B.1 7.1	5	20 mm (0.8 in)	17 mm (0.7 in)
	ISO/IEC TR 14763-3 6.22	5	20 mm (0.8 in)	20 mm (0.8 in)

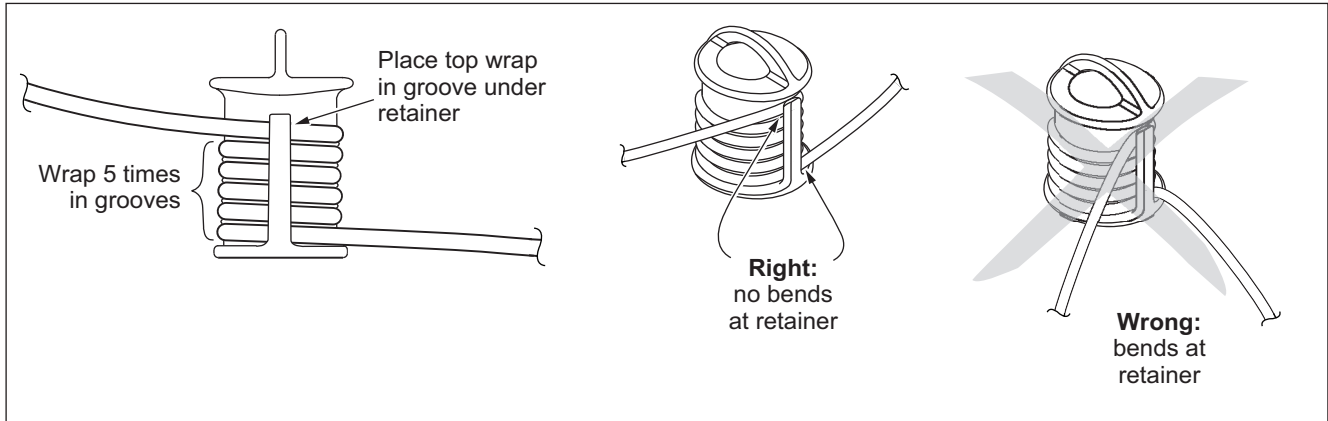

amd67f.eps

Figure 3. Wrapping a Patch Cord Around a Mandrel

Testing Your Patch Cords

You should test your patch cords before each job. Use another set of known-good patch cords to set a reference and run an Autotest on each patch cord. Use Smart Remote mode to test two patch cords at a time, or Loopback mode to test one patch cord. See pages 17 and 22 for details on running these tests. For SC/SC patch cords, you can also use the method described in TIA/EIA TSB140.

Fiber Test Settings

Table 2 describes the test settings that apply to fiber cabling.

To access the fiber test settings turn the rotary switch to **SETUP**; then select **Fiber**. Use   to see different tabs.

Table 2. Fiber Test Settings

Setting	Description
SETUP > Fiber > Fiber Type	Select a fiber type that is appropriate for the type you will test. Selecting Custom lets you create a fiber type. See the Technical Reference Handbook for details.
SETUP > Fiber > Test Limit	Select the appropriate test limit for the job. The tester compares the fiber test results to the selected test limit to produce PASS or FAIL results. Selecting Custom lets you create a test limit. See the Technical Reference Handbook for details.
SETUP > Fiber > Remote End Setup	Use Smart Remote mode for testing dual-fiber cabling. Use Loopback mode for testing patch cords and cable spools. Use Far End Source mode with an optical source for testing individual fibers.

-continued-

Table 2. Fiber Test Settings (cont.)

Setting	Description
SETUP > Fiber > Bi-Directional	When enabled in Smart Remote or Loopback mode, the tester prompts you to swap the test connections halfway through the test. The tester can then make bi-directional measurements for each fiber at each wavelength (850 nm/1300 nm, 850 nm/1310 nm, or 1310 nm/1550 nm).
SETUP > Fiber > Number of Adapters SETUP > Fiber > Number of Splices	If the selected limit uses a calculated loss limit, enter the number of adapters and splices that will be added to the fiber path after the reference is set. Figure 4 shows an example of how to determine the Number of Adapters setting. Only limits that use maximum values for loss per km, loss per connector, and loss per splice use a calculated limit for overall loss. For example, limits for fiber backbones use a calculated loss limit.
SETUP > Fiber > Connector Type	Select the type of connector used in the cabling. This setting affects only the diagrams shown for reference connections. If the cabling's connector type is not listed, use General .

-continued-

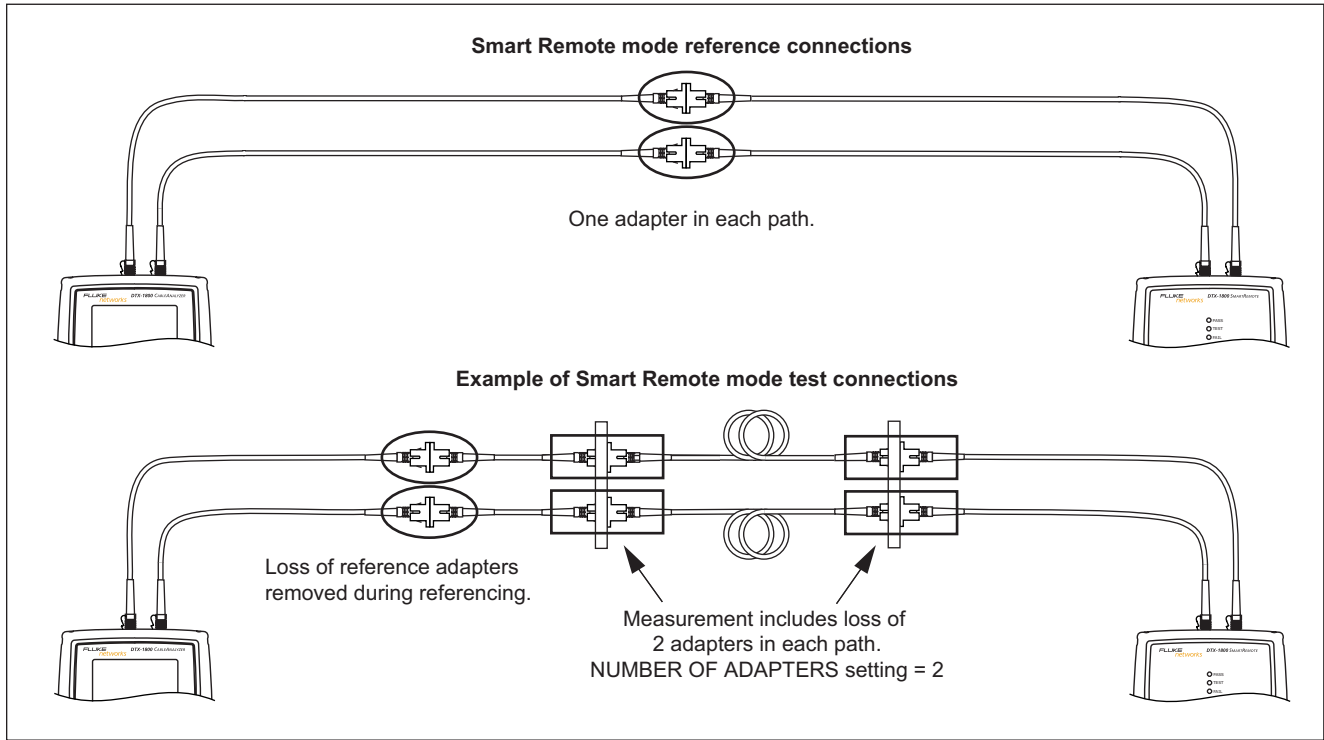

amd65f.eps

Figure 4. Example of How to Determine the Number of Adapters Setting (singlemode example; mandrels not used)

Table 2. Fiber Test Settings (cont.)

Setting	Description
SETUP > Fiber > Test Method > Method A, B, C	<p>Loss results include connections added after referencing. The reference and test connections determine which connections are included in results. The Test Method refers to the number of end connections included:</p> <p>Method A: Loss results include one connection at one end of the link.</p> <p>Method B: Loss results include connections at both ends of the link. The reference and test connections shown in this manual produce Method B results, but are modified versions of connections shown in the standards. The modified connections let you connect to links that do not use SC connectors, while ensuring Method B results. For links with small form-factor (SFF) connectors or different connector types at each end, use hybrid patch cords or alternate reference and test connections. See the <i>Technical Reference Handbook</i> or visit the Fluke Networks Knowledge Base for suggestions.</p> <p>Method C: Loss results exclude connections at the ends of the link. Only the fiber loss is measured.</p> <p>Different standards have different names for the three test methods. See Appendix A for details. The <i>Technical Reference Handbook</i> provides additional information on test methods.</p> <p>This setting does not affect loss results. It is only saved with the results to record which method you used.</p>

-continued-

Table 2. Fiber Test Settings (cont.)

Setting	Description
SETUP > Fiber > Index of Ref. Source (n) > User Defined or Default	<p>The tester uses the index of refraction (n) defined in the currently selected fiber type (Default) or a value you define (User Defined). The default value defined by the selected fiber type represents the typical value for that fiber type. You may enter a different value if necessary. To determine the actual value, change the index of refraction until the measured length matches the known length of a fiber.</p> <p>Increasing the index of refraction decreases measured length.</p>
SPECIAL FUNCTIONS > Set Reference Patch Lengths (softkey on the View Connections screen)	<p>Setting a reference sets the baseline power level for loss measurements. See "About Setting the Reference" on page 9.</p> <p>After you set the reference, you can enter the lengths of the patch cords used. The lengths are saved with results to meet TSB-140 reporting requirements for fiber test results.</p>
Settings for saving tests	<p>See the <i>DTX Series CableAnalyzer Users Manual</i> or <i>Technical Reference Handbook</i> for details on preparing to save tests.</p>

Certifying Fiber Cabling

The Autotest runs the tests required to certify that fiber cabling meets a particular standard. You run the Autotest in Smart Remote, Loopback, or Far End Source mode, depending on whether you are testing duplex cabling, spools or patch cords, or single-fiber cabling.

Autotest in Smart Remote Mode

Use Smart Remote mode to test and certify dual-fiber cabling. In this mode, the tester measures loss, length, and propagation delay on two fibers at two wavelengths in one or both directions.

Figure 5 shows the equipment required for testing fiber in Smart Remote mode.

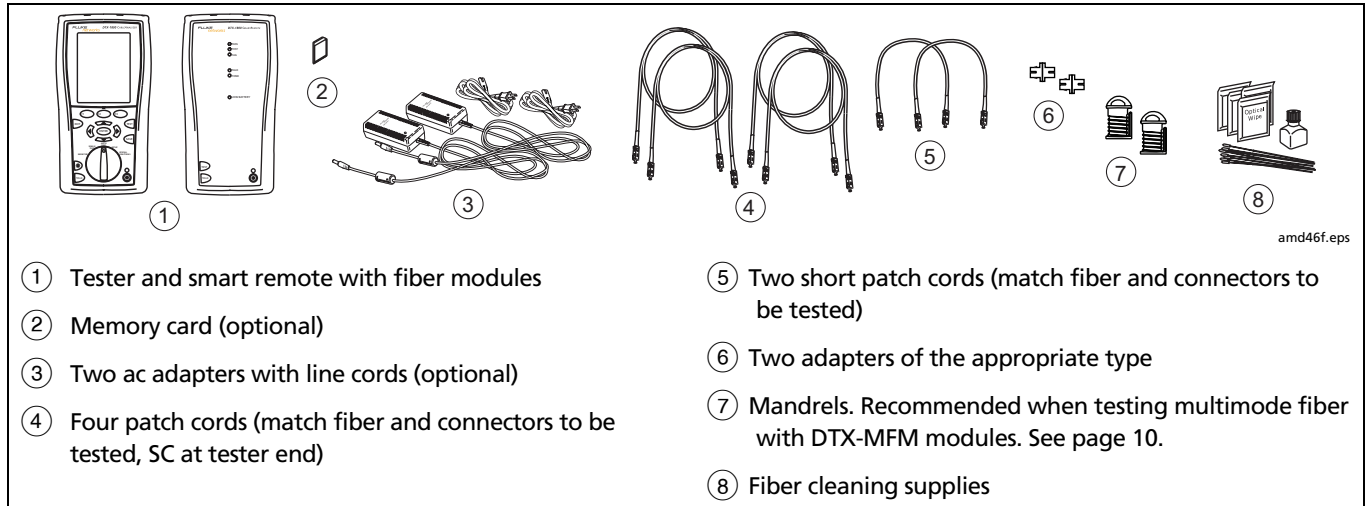



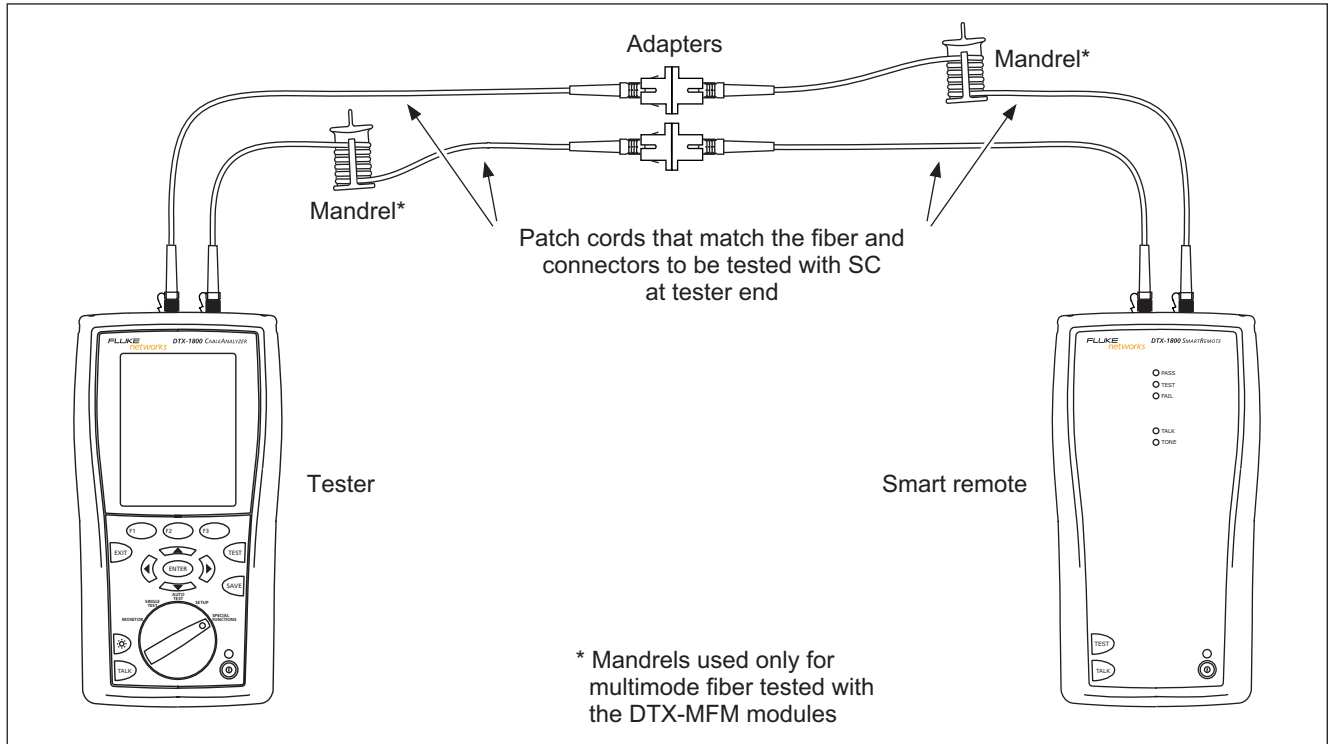

Figure 5. Equipment for Testing in Smart Remote Mode

Autotest in Smart Remote Mode

- 1 Turn on the tester and smart remote and let them sit for 5 minutes. Allow additional time if the modules have been stored above or below ambient temperature.
 - 2 Turn the rotary switch to **SETUP**, then select **Fiber**. Set the following on the **Fiber** tabs (press  to see other tabs):
 - **Fiber Type:** Select the fiber type to be tested.
 - **Test Limit:** Select the test limit required for the job. Press  **More** to see other lists of limits.
 - **Remote End Setup:** Set to **Smart Remote**.
 - **Bi-directional:** Enable this if you are required to test the fiber in both directions.
 - **Number of Adapters and Number of Splices:** Enter the number of adapters and splices that will be added to each direction of the fiber path after the reference is set.
 - **Connector Type:** Select the connector type used in the cabling to be tested. Select **General** if the exact type is not listed.
 - **Test Method:** Refers to the number of adapters represented in the loss results. Select **Method B** if you use the reference and test connections shown in this manual.
 - 3 Turn the rotary switch to **SPECIAL FUNCTIONS**, then select **Set Reference**. If both a fiber module and a twisted pair or coaxial adapter are attached, select **Fiber Module** next.
 - 4 The **Set Reference** screen shows reference connections for the test method you selected. Figure 6 shows connections for Method B. Clean the connectors on the testers and patch cords, connect the tester and smart remote; then press .
- See Table 2 on page 12 for details on settings.

-continued-







amd47f.eps

Figure 6. Smart Remote Mode Reference Connections (Modified Method B)

Autotest in Smart Remote Mode (cont.)**Caution**

If you disconnected the patch cords from the tester's or smart remote's output port since setting the reference, you must set the reference again to ensure valid measurements.

- 5 Clean the connectors on the cabling to be tested; then connect the patch cords to the cabling. The tester shows test connections for the test method you selected. Figure 7 shows connections for Method B.
- 6 Turn the rotary switch to **AUTOTEST**. Verify that the media type is set to **Fiber**. Press  **Change Media** to change it if necessary.
- 7 Press  on the tester or smart remote.
- 8 If **Open** or **Unknown** appears, try the following:
 - Verify that all connections are good.

- Verify that the tester at the other end is on. (The tester cannot activate a sleeping or powered-down tester at the far end through the fiber modules.)
 - Try different connections at the patch panel.
 - Use the visual fault locator to verify fiber continuity.
- 9 If bi-directional testing is enabled, the tester prompts you to switch the fibers halfway through the test. Switch the fibers at the patch panels or adapters (not at the tester's ports) at both ends of the cabling.
 - 10 To save the results, press , select or create a fiber ID for the input fiber; then press . Select or create a fiber ID for the output fiber; then press  again.

In the results for Smart Remote mode, **Input Fiber** and **Output Fiber** refer to the fibers connected to the main tester's input and output ports. For a bi-directional test, these are the fibers connected to the main tester's input and output ports at the *end* of the test.

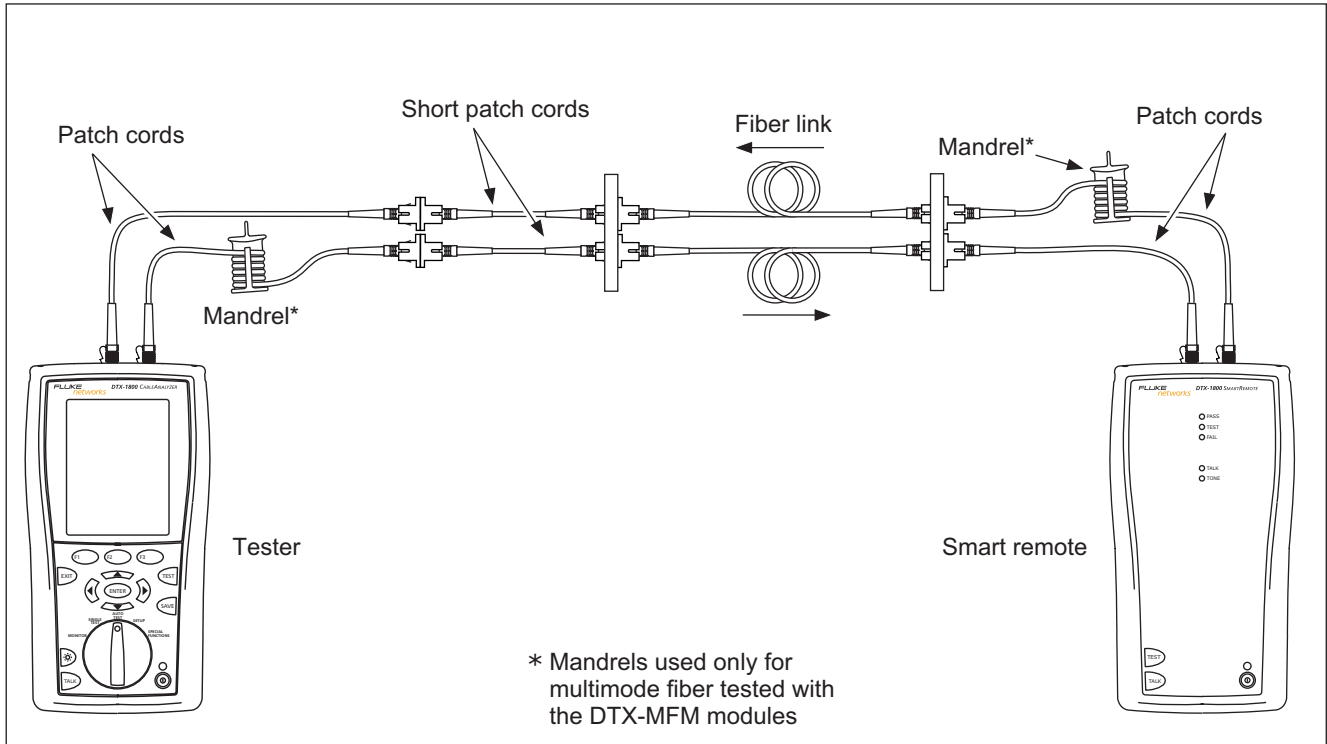

Figure 7. Smart Remote Mode Test Connections (Modified Method B)

amd48f.eps

Autotest in Loopback Mode

Use Loopback mode to test spools of cable, segments of uninstalled cable, and patch cords.

In this mode, the tester measures loss, length, and propagation delay at two wavelengths in one or both directions.

Figure 8 shows the equipment required for testing fiber in Loopback mode.

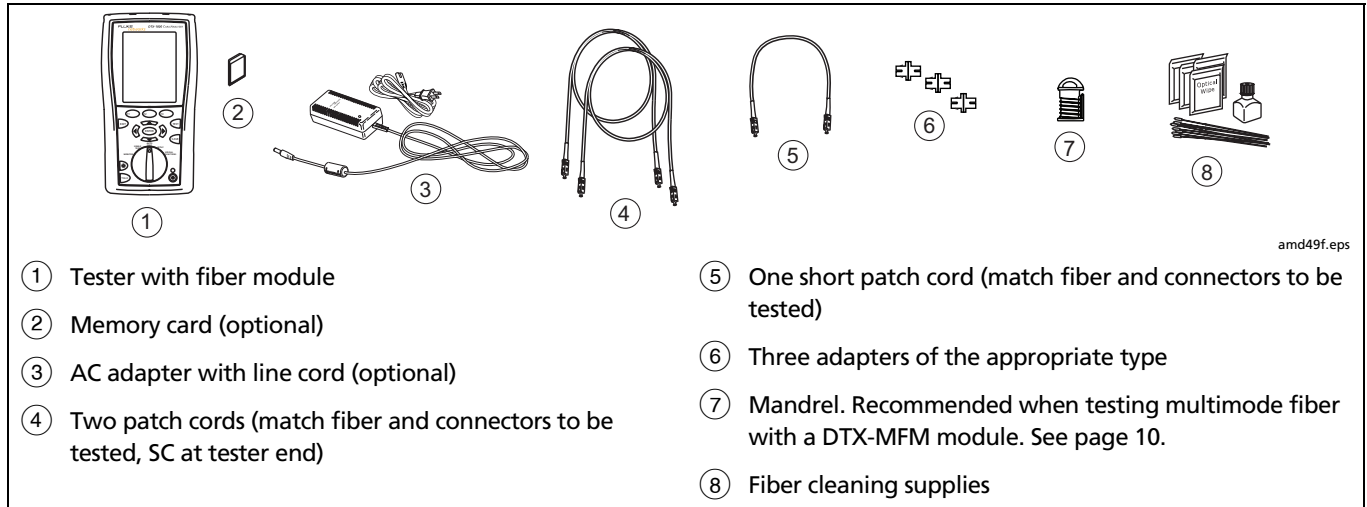





Figure 8. Equipment for Testing in Loopback Mode

Autotest in Loopback Mode

- 1 Turn on the tester and smart remote and let them sit for 5 minutes. Allow additional time if the modules have been stored above or below ambient temperature.
 - 2 Turn the rotary switch to **SETUP**, then select **Fiber**. Set the following on the **Fiber** tabs (press  to see other tabs):
 - **Fiber Type:** Select the fiber type to be tested.
 - **Test Limit:** Select the test limit required for the job. Press  **More** to see other lists of limits.
 - **Remote End Setup:** Set to **Loopback**.
 - **Bi-directional:** Enable this if you are required to test the fiber in both directions.
 - **Number of Adapters and Number of Splices:** Enter the number of adapters and splices that will be added to each direction of the fiber path after the reference is set.
 - **Connector Type:** Select the connector type used in the cabling to be tested. Select **General** if the exact type is not listed.
 - **Test Method:** Refers to the number of adapters represented in the loss results. Select **Method B** if you use the reference and test connections shown in this manual.
 - 3 Turn the rotary switch to **SPECIAL FUNCTIONS**, then select **Set Reference**. If both a fiber module and a twisted pair or coaxial adapter are attached, select **Fiber Module** next.
 - 4 The **Set Reference** screen shows connections for the test method you selected. Figure 9 shows connections for Method B. Clean the connectors on the tester and patch cords, connect the tester's INPUT and OUTPUT ports; then press .
- See Table 2 on page 12 for details on settings.

-continued-

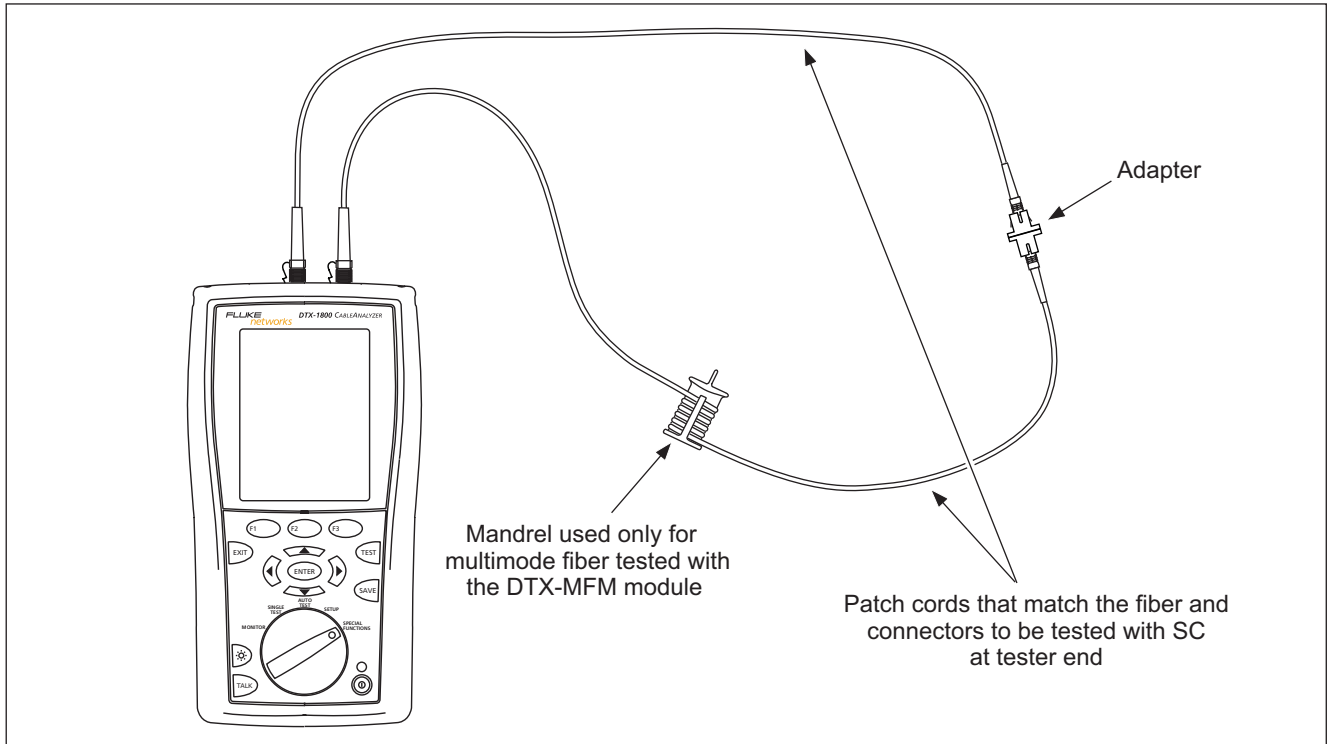





Figure 9. Loopback Mode Reference Connections (Modified Method B)

amd50f.eps

Autotest in Loopback Mode (cont.)

Caution

If you disconnected the patch cord from the tester's output port since setting the reference, you must set the reference again to ensure valid measurements.

- 5 Clean the connectors on the cabling to be tested; then connect the patch cords to the cabling. The tester shows connections for the test method you selected. Figure 10 shows connections for Method B.
- 6 Turn the rotary switch to **AUTOTEST**. Verify that the media type is set to **Fiber**. Press  **Change Media** to change it if necessary.
- 7 Press .
- 8 If bi-directional testing is enabled, the tester prompts you to switch the fibers halfway through the test. Switch the fibers at the adapters (not at the tester's ports).
- 9 To save the results, press , select or create a fiber ID; then press  again.

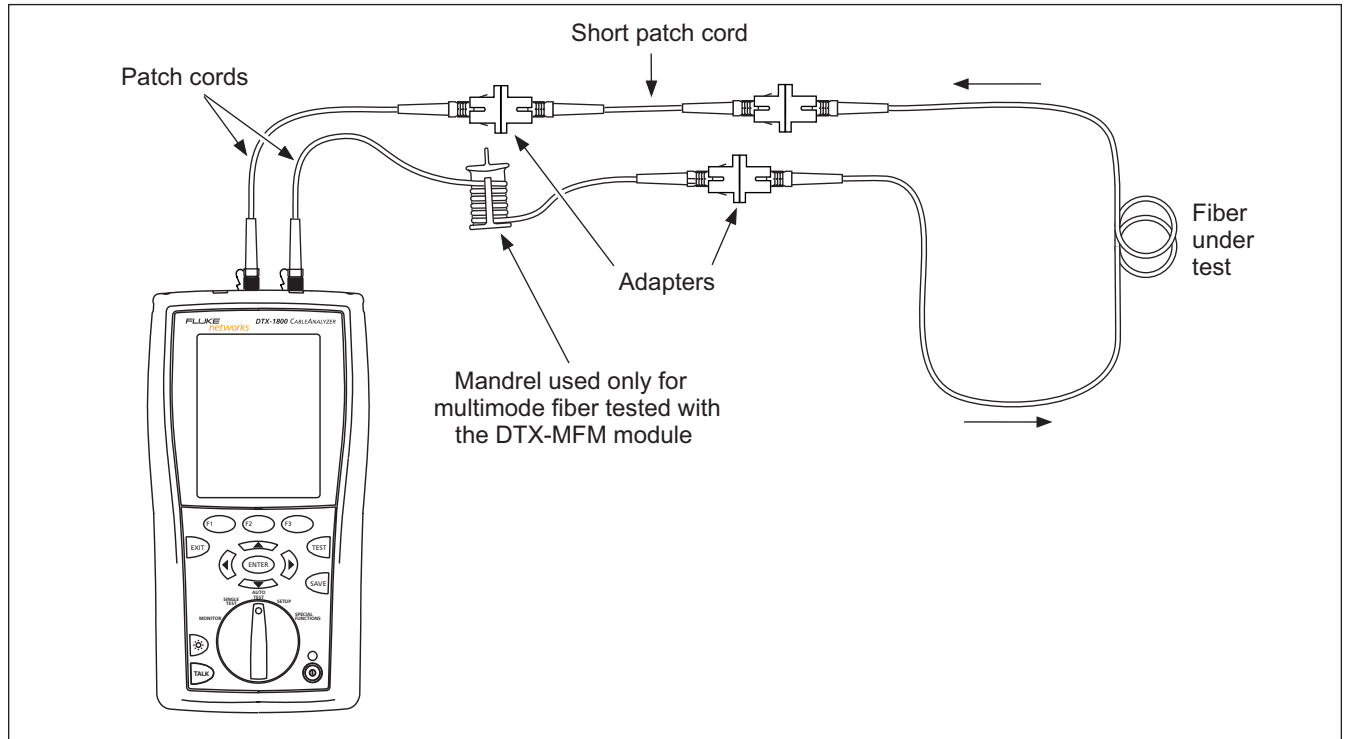

Figure 10. Loopback Mode Test Connections

amd24f.eps

Autotest in Far End Source Mode

Use Far End Source mode to measure loss at one wavelength on individual fibers.

Far End Source mode requires a stand-alone optical source. Figure 11 shows the equipment required for testing fiber in Far End Source mode.

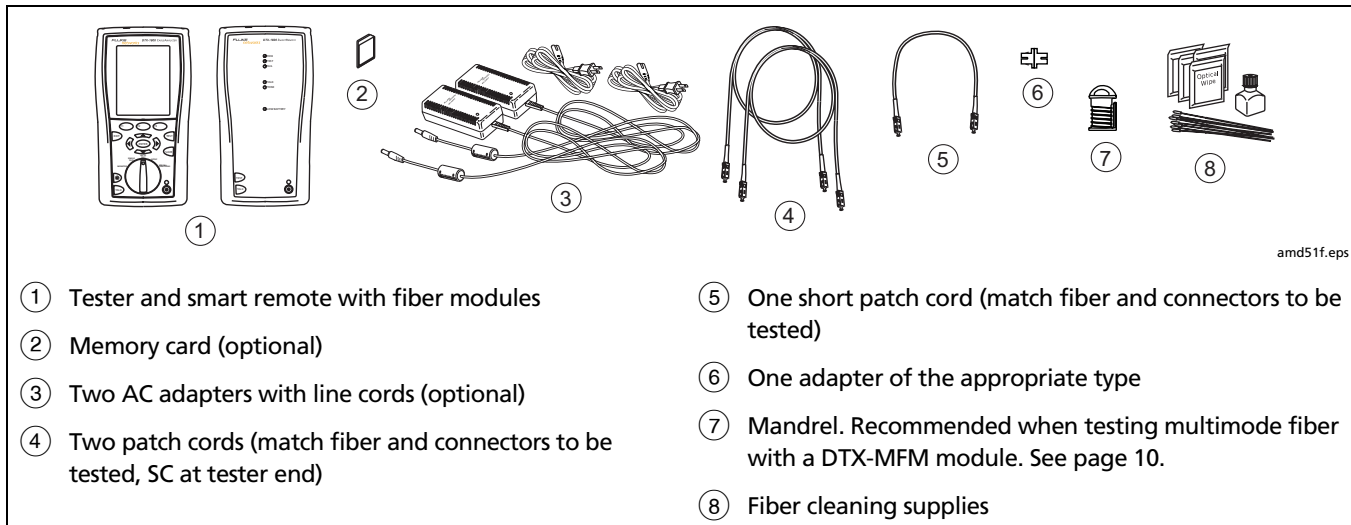



Figure 11. Equipment for Testing in Far End Source Mode

Autotest in Far End Source Mode

- 1 Turn on the tester and smart remote and let them sit for 5 minutes. Allow additional time if the modules have been stored above or below ambient temperature. For other sources, warm up according to the manufacturer's recommendations.
 - 2 Turn the rotary switch to **SETUP**, then select **Fiber**. Set the following on the **Fiber** tabs (press  to see other tabs):
 - **Fiber Type:** Select the fiber type to be tested.
 - **Test Limit:** Select the test limit required for the job. Press  **More** to see other lists of limits.
 - **Remote End Setup:** Set to **Far End Source**
 - **Bi-directional:** Does not apply to Far End Source mode.
 - **Number of Adapters and Number of Splices:** Does not apply to Far End Source mode.
 - **Connector Type:** Select the connector type used in the cabling to be tested. Select **General** if the exact type is not listed.
 - **Test Method:** Refers to the number of adapters represented in the loss results. Select **Method B** if you use the reference and test connections shown in this manual.
- See Table 2 on page 12 for details on settings.

-continued-

Autotest in Far End Source Mode (cont.)

- 3 Hold down the button on the smart remote's fiber module for 3 seconds to turn on the output port at 850 nm (DTX-MFM/GFM) or 1310 nm (DTX-SFM). Press again to switch to 1300 nm (DTX-MFM), 1310 nm (DTX-GFM), or 1550 nm (DTX-SFM).



The LED is red for the shorter wavelength and green for the longer wavelength.

For other sources, verify the output is set to the correct wavelength and is in continuous-wave mode.

- 4 Turn the rotary switch to **SPECIAL FUNCTIONS**, then select **Set Reference**. If both a fiber module and a twisted pair or coaxial adapter are attached, select **Fiber Module** next.
- 5 The **Set Reference** screen shows connections for the test method you selected. Figure 12 shows connections for Method B. Clean the connectors on the tester, patch cords, and source, connect the tester and source; then press .

Caution

If you disconnect the patch cord from the source's output port after setting the reference, you must set the reference again to ensure valid measurements.

- 6 Clean the connectors on the cabling to be tested; then connect the tester and source to the cabling. The tester shows connections for the test method you selected. Figure 13 shows connections for Method B.
- 7 Turn the rotary switch to **AUTOTEST**, press ; then select the wavelength set on the smart remote.
- 8 To save the results, press , select or create a fiber ID; then press  again.

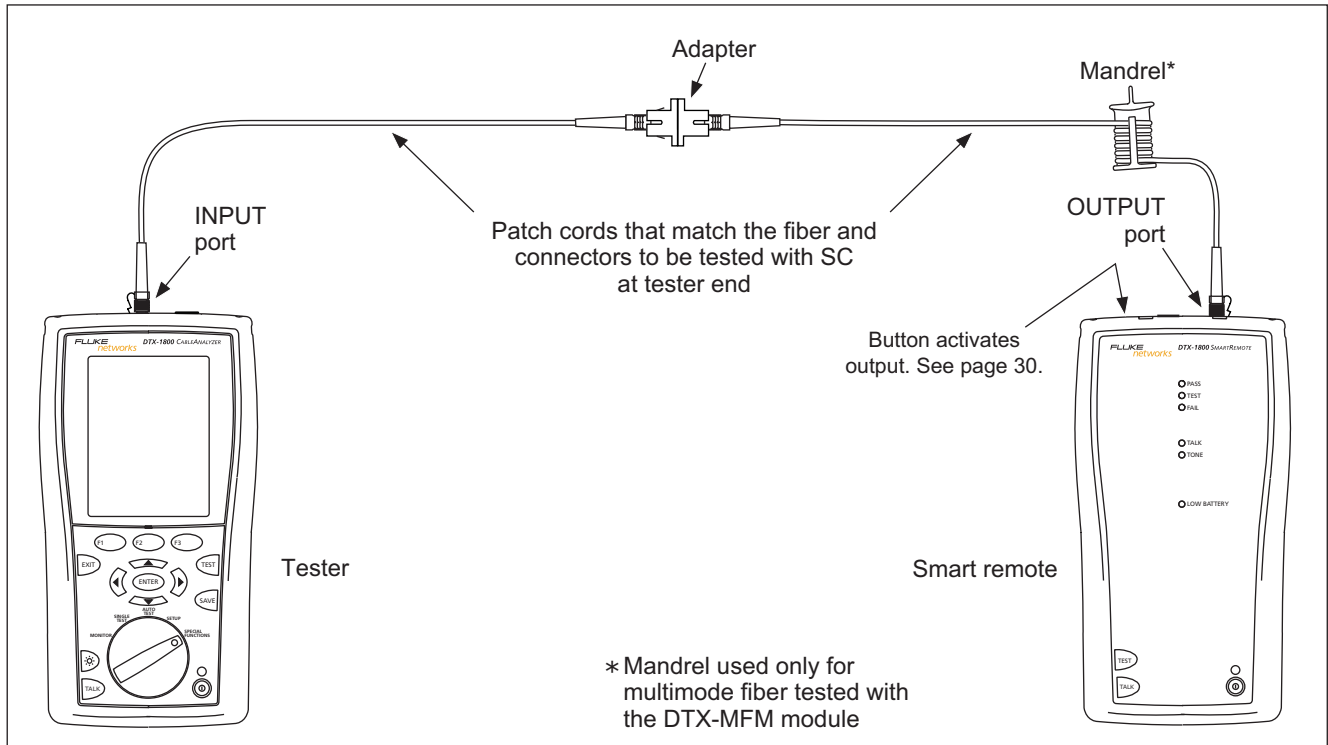
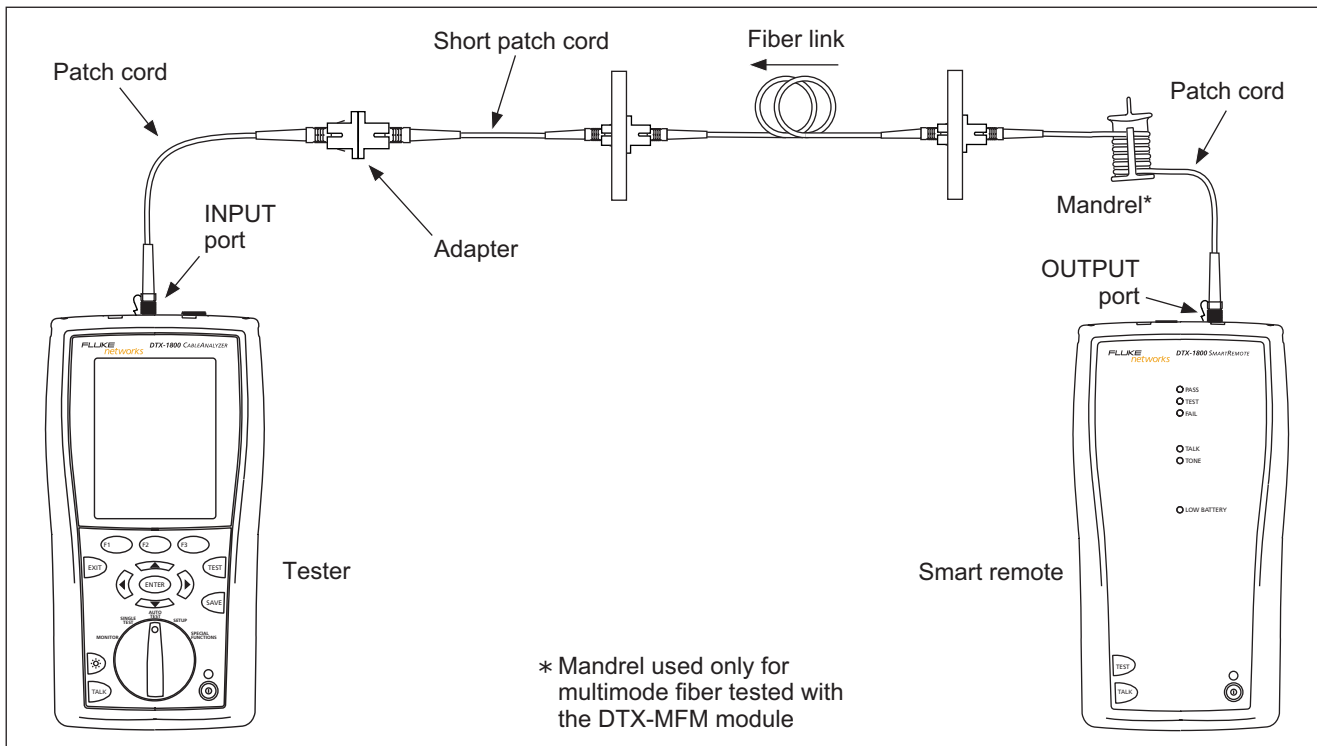

Figure 12. Far End Source Mode Reference Connections (Modified Method B)

amd68f.eps



amd52f.eps

Figure 13. Far End Source Mode Test Connections

Using the Visual Fault Locator

The fiber module includes a visual fault locator that helps you quickly check fiber continuity, trace fibers, and locate faults along fibers and in connectors.

The visual fault locator port accepts connectors with 2.5 mm ferrules (SC, ST, or FC). To connect to other ferrule sizes, use a patch cord with the appropriate connector at one end and a SC, ST, or FC connector at the tester end.

Figure 14 shows the equipment needed for using the visual fault locator.

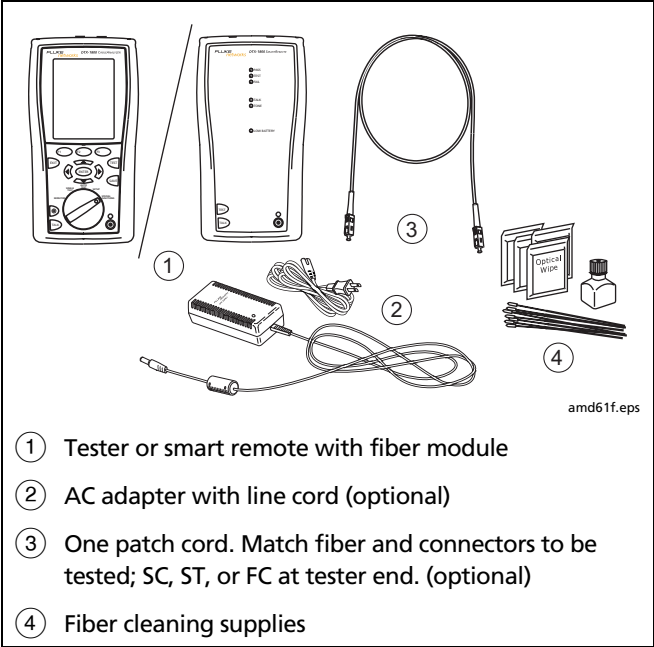

Figure 14. Equipment for Using the Visual Fault Locator

Using the Visual Fault Locator

- 1** Clean the connectors on the patch cord, if used, and the fiber to be tested.
- 2** Connect the fiber directly to the tester's VFL port or connect using the patch cord.
- 3** Turn on the visual fault locator by pressing the button near the VFL connector, as shown in Figure 15. Press again to switch to flashing mode. Press again to turn off the locator.
- 4** Look for the red light to locate fibers or faults (Figure 15):
 - To check continuity or trace fiber connections, look for the red light at the end of the fiber. View the VFL's light indirectly by holding a white card or paper in front of the fiber connector emitting the light.
 - To locate faults, move along the fiber from either end, looking for a red glow coming from the fiber jacket or a connector housing.

Note

The locator's light may not be visible through dark-colored fiber jackets.

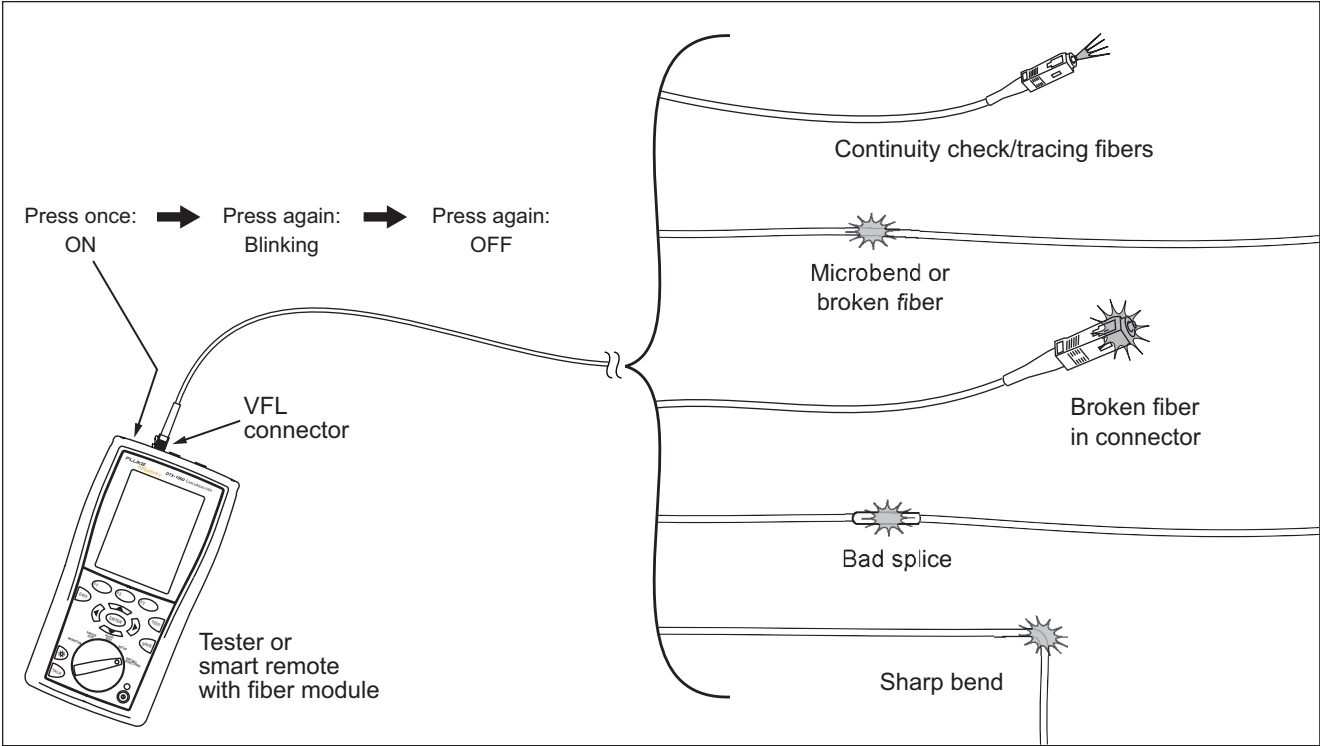

Figure 15. Using the Visual Fault Locator

amd23f.eps

Monitoring Optical Power

The power meter lets you monitor the optical power produced by a source such as an optical network interface card or optical test equipment.

The tester offers two versions of the power meter function:

- **SINGLE TEST** mode: Measures power in the current remote end configuration (Smart Remote, Loopback, or Far End Source mode). Takes one power measurement at 850 nm and 1300 nm (DTX-MFM), 850 nm and 1310 nm (DTX-GFM), or 1310 nm and 1550 nm (DTX-SFM). You can save the power measurement in this mode.
- **MONITOR** mode: Monitors power continuously at the input port at 850 nm, 1300 nm, 1310 nm, or 1550 nm. This measurement cannot be saved.

Figure 16 shows the equipment required for monitoring power in the **MONITOR** mode.

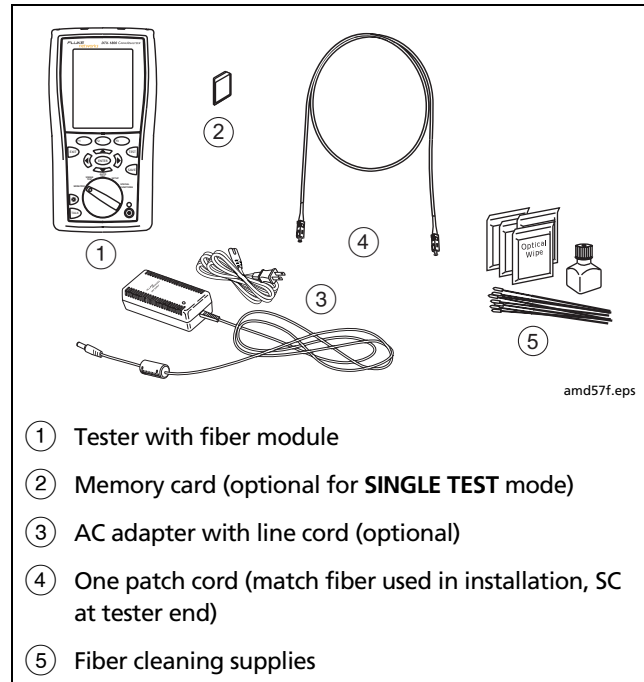

Figure 16. Equipment for Monitoring Optical Power

Monitoring Optical Power

- 1 Clean the tester's input port and the patch cord and source connectors.
- 2 Use the patch cord to connect the source to the tester's input port, as shown in Figure 17. Turn on the source.
- 3 Turn the rotary switch to **MONITOR**. If the media type is not set to **Fiber**, press **F1** **Change Media** to change it.
- 4 Select **Power Meter**. You do not need to select a fiber type or test limit.
- 5 Select the correct wavelength; then press **TEST**.
To change the wavelength after starting the test, press **F3** **Change λ** .

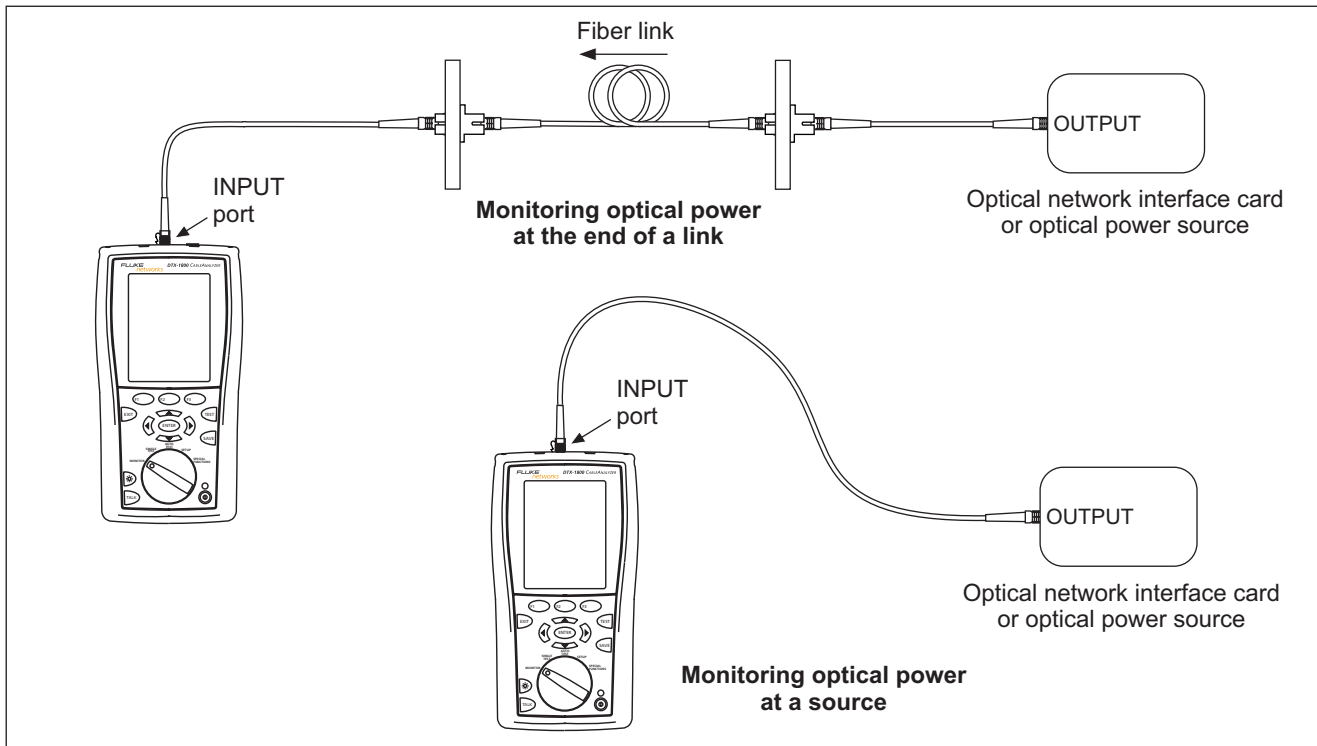

Figure 17. Connections for Monitoring Optical Power

amd58f.eps

Options and Accessories

Table 3 shows options and accessories available for the DTX Series CableAnalyzers. For a complete list of options

and accessories visit the Fluke Networks website at www.flukenetworks.com.

To order options or accessories, contact Fluke Networks as described on page 2.

Table 3. Options and Accessories

Option or Accessory	Fluke Networks Model Number
DTX-MFM Multimode Fiber Module, 850 nm/1300 nm	DTX-MFM
DTX-GFM Gigabit Fiber Module, 850 nm/1310 nm	DTX-GFM
DTX-SFM Singlemode Fiber Module, 1310 nm/1550 nm	DTX-SFM
DTX-FTK Fiber Test Kit Fiber optic meter module and 850 nm/1300 nm SimpliFiber™ source. Measures power and loss at 850 nm/1300 nm (1310 nm/1550 nm with optional source).	DTX-FTK
DTX-FOM Fiber Optic Meter Module Measures power and loss at 850 nm/1300 nm and 1310 nm/1550 nm.	DTX-FOM
Fiber Jack Accessory Kit, 62.5 µm multimode	NFK1-FJ
LC Accessory Kit, 62.5 µm multimode	NFK1-LC

-continued-

Table 3. Options and Accessories (cont.)

Option or Accessory	Fluke Networks Model Number
MT-RJ Accessory Kit, 62.5 μm multimode	NFK1-MTRJ
MT-RJ Accessory Kit, 50 μm multimode	NFK2-MTRJ
VF-45 Accessory Kit, 62.5 μm multimode	NFK1-VF45
VF-45 Accessory Kit, 50 μm multimode	NFK2-VF45
ST Cable Kit, 50 μm multimode	NFK2-ST
Fiber Optic Cleaning Kit	NF430
ST/ST Singlemode Fiber Optic Adapter	NF300SM
SC/SC Singlemode Fiber Optic Adapter	NF310SM
ST/FC Simplex 62.5 μm 1m patch cord	FOC-ST/FC
ST/ST Simplex 62.5 μm 1m patch cord	FOC-ST/ST
ST/SC Simplex 62.5 μm 1m patch cord	FOC-ST/SC

-continued-

Table 3. Options and Accessories (cont.)

Option or Accessory	Fluke Networks Model Number
ST/SMA Simplex 62.5 μm 1m patch cord	FOC-ST/SMA
ST/FC Simplex Singlemode 1m patch cord	NF120SM
ST/ST Simplex Singlemode 1m patch cord	NF100SM
ST/SC Simplex Singlemode 1m patch cord	NF110SM
SC/SC Simplex 62.5 μm 1m patch cord	NF215
ST/ST Simplex 62.5 μm 1m patch cord	NF230
Red Multimode Fiber Mandrel for 50 μm fiber with 3 mm jackets	NF-MANDREL-50
Gray Multimode Fiber Mandrel for 62.5 μm fiber with 3 mm jackets	NF-MANDREL-625
Multimode Fiber Mandrel kit containing two red 50 μm mandrels and two gray 62.5 μm mandrels	NFK1-MANDREL-KIT

Maintenance

Follow the maintenance procedures given in the *DTX Series CableAnalyzer Users Manual*.

Clean the optical connectors as described on page 8.

Replacing Fiber Patch Cords

Choose replacement fiber optic patch cords that meet the following requirements:

- Core and cladding size: match the fiber to be tested
- Connector polish: PC or UPC
- Patch cord length: maximum 5 m

To ensure optimum performance from your tester, get replacement patch cords from Fluke Networks.

Using the Smart Remote with an OptiFiber™ Certifying OTDR

You can use a DTX Series smart remote with a DTX-MFM or DTX-SFM fiber module as the remote for a Fluke Networks OptiFiber Certifying OTDR. The DTX remote takes the place of a second OptiFiber tester for measuring loss and length with the OptiFiber loss/length option in Smart Remote mode. You can buy a smart remote separately for this purpose. See the Fluke Networks website or contact Fluke Networks for details.

Certification, Compliance, and Regulatory Information



N10140

Conforms to relevant Australian standards



Conforms to relevant European Union directives.



Listed by the Canadian Standards Association.

Laser safety

OUTPUT port: Class 1
VFL port: Class 2
Complies with EN60825-1 and EN61010-1 (CE) and CFR21

Appendix A: Test Method Reference Tables

Industry standards use different names for equivalent test methods. Table A-1 shows the names used in this manual and by four common industry standards for the three fiber test methods

Table A-1. Test Method Names

Link End Connections Included in Loss Results	This Manual	TIA/EIA-526-14A (multimode)	TIA/EIA-526-7 (singlemode)	IEC 61280-4-1 (multimode)	IEC 61280-4-2 (singlemode)
1 connection	Method A	Method A	Method A.2	Method 1	Method A2
2 connections	Method B	Method B	Method A.1	Method 2	Method A1
None	Method C	Method C	Method A.3	Method 3	Method A3

Table A-2 shows the test methods required by standards.

Table A-2. Test Methods Required by Standards

Standard or Application	Test Method (as named in this manual)
TIA-568-B	B
ISO 11801	B
EN50173	B
10BASE-FB	A
10BASE-FP	A
10BASE-FL	A
10/100BASE-SX	B
100BASE-FX	B
1000BASE-LX	B
1000BASE-SX	B

Standard or Application	Test Method (as named in this manual)
10GBASE-S	B
10GBASE-L	B
10GBASE-LX	B
10GBASE-E	B
Fibre Channel	B
ATMI	B
FDDI	B
Token Ring	B
Fluke Networks General Fiber	B

Index

—A—

accessories, 3, 39

Autotest

Far End Source mode, 28

Loopback mode, 22

Smart Remote mode, 17

—B—

Bi-Directional, 13

—C—

cautions, 4

cleaning connectors and adapters, 8

connections. See Smart Remote,
Loopback, or Far End Source mode

alternate, 15

Connector Type, 13

Custom Fiber Type and Test Limit, 12

—F—

Far End Source mode

Autotest, 29

equipment, 28

reference connections, 31

test connections (Modified Method
B), 32

Fiber Type, 12

Fluke Networks

contacting, 2

Knowledge Base, 2

—I—

index of refraction, 16

installation and removal, 6

—K—

Knowledge Base, 2

—L—

Loopback mode

Autotest, 24

equipment, 23

reference connections, 25

results, 26

test connections (Modified Method
B), 27

loss is negative, 9

—M—

mandrels, 10

Method A, B, C, 15

—N—

n, 16

negative loss, 9

Number of Adapters, 13

Number of Splices, 13

—O—

Open (Smart Remote mode), 20

options, 39

—P—

patch cord

 replacement, 42

 testing, 8, 11

Patch Lengths, 16

power meter, 36

—R—

reference

 alternate connections, 15

 Far End Source mode, 30

 Loopback mode, 24

 Smart Remote mode, 18

 when to set, 9

registration, 1

Remote End Setup, 12

—S—

safety, 4

settings, 12

SFF connectors, 15

small form-factor connectors, 15

Smart Remote mode

 Autotest, 18

 equipment, 17

 reference connections, 19

 results, 22

 test connections, 21

—T—

Test Limit, 12

Test Method, 45

—U—

Unknown (Smart Remote mode), 20

—V—

visual fault locator, 33

—W—

warnings, 4