

JDSU MSAM Module Specs

Provided by www.AAATesters.com

T-BERD®/MTS-6000A

Multi-Services Application Module



Key Features

- Modular form-factor enables field upgrade of test capabilities by adding or replacing PIMs and optics
- Multi-service capability allows simultaneous Ethernet, Fibre Channel, and SONET/SDH/PDH/OTN testing through physical port
- Performs two independent tests in parallel with dual-port chassis
- Supports PBB/PBT, Ethernet OAM, VLAN, Q-in-Q, VPLS, MPLS Tunneling applications, and IP
- Identifies problems with fiber optics faster with optical power source, high accuracy power meter, OTDR, CD, PMD, and WDM
- Provides visual fault locator and fiber microscope
- Allows for control remotely (Ethernet/IP) and VT-100 emulation

Applications

- Tests 10 GigE LAN- and WAN-PHY at 850, 1310, and 1550 nm wavelengths (single-port)
- Tests dual- and single-port 10 Mb/s to 1 GbE
- Supports 1G/2G/4G/10G Fibre Channel and FICON for Storage Area Networks with automated FC testing and buffer-to-buffer control verification, Fibre Channel Login
- Tests OTN at 2.7, 10.7, 11.05, and 11.1 Gb/s bit rates with SONET/SDH and Ethernet client emulation
- Tests T-carrier and PDH with T1, E1, E3, DS3, and E4 interfaces and mappings
- Tests Ethernet OAM, PBB/PBT, and transparency of Layer 2 services
- Tests SONET/SDH at OC-3/STM-1 through OC-192/STM-64 line rates
- Tests Layer 1-4 Ethernet with RFC2544, VLAN, Q-in-Q, VPLS, and MPLS
- Tests TCP/UDP at 10 Mb/s to 10 Gb/s with stateful emulation
- Tests FTP/HTTP/Telnet
- Tests IP Video at 10 Mb/s to 10 GigE line rates

In one rugged, handheld unit, the T-BERD/MTS-6000A Multi-Services Application Module (MSAM) delivers the industry's most compact and powerful 10-Gigabit Ethernet (GbE) multifunction tester for the installation and maintenance of carrier-grade Ethernet and Internet Protocol (IP) services. Technicians can also add testing capability with pluggable physical interface modules (PIMs), small form-factor pluggable modules (SFPs), and 10 Gb/s small form-factor modules (XFPs) to create a variety of field-configurable optical/electrical test combinations.

Transport and Special Services technicians using this modular handheld field tester can quickly turn up and maintain Metro Core networks. Features include Ethernet and synchronous optical network technologies/synchronous digital hierarchy (SONET/SDH) testing at line rates from 10 Mb/s up to 10 Gb/s. It can also verify and troubleshoot higher-layer IP video, Layer 4 (L4) User Datagram Protocol/Transmission Control Protocol (UDP/TCP), File Transfer Protocol (FTP), and Hypertext Transfer Protocol (HTTP). A powerful user interface helps technicians quickly set up and evaluate tests as well as troubleshoot problems, reducing operational expense.

With field applications for servicing Metro Core telecom networks, wireless/cable switch centers and backhaul networks, government telecommunications and network equipment manufacturer field installation and support groups, the Multi-Services Application Module is the latest innovation for the award-winning, industry-leading T-BERD/MTS family of test solutions.

Ethernet and IP

The Multi-Services Application Module enables transport technicians to quickly turn up and maintain Metro Core networks. It can verify end-to-end connectivity, measure bit error rate (BER), and determine whether throughput, utilization, frame loss, packet jitter, and round-trip delay (RTD) characteristics meet service level agreements (SLA). It can perform Ethernet and SONET/SDH tests at line rates from 10 Mb/s to 10 Gb/s. The Multi-Services Application Module can also test a wide range of mechanism and tunneling technologies, including 10 GigE within 11.05 and 11.1 Gb/s optical transport network (OTN). It can also verify the full transparency of Layer 2 (L2) networks by generating and analyzing a large number of control plane frames, which the user can customize. With Ethernet operation, administration, and maintenance (OAM), users can verify the link connectivity, insert alarms, and initiate loopbacks. On electrical Ethernet circuits, the Multi-Services Application Module can display the link speed, link status, cable status, media delivery index/media delivery index crossover media delivery index/media delivery index crossover (MDI/MDI-X), and distance to fault with the press of a button.

Powerful IPTV Test Abilities

The Multi-Services Application Module provides comprehensive Internet Protocol television (IPTV) test capabilities. Technicians can verify network provisioning through video stream access at various network points and analyze receipt of the streams and their quality of service (QoS) at each point. This capability enables them to verify that the physical, transport, and video stream layers are free of errors and alarms. Technicians also can perform detailed troubleshooting in selected streams to verify transport layer conditions, including packet loss, jitter, MDI, distance error, and period errors. Technicians also can verify conditions of video stream layer, including program clock reference (PCR) jitter, sync loss errors, and continuity counter errors, such as video packet loss, transport error indicators, and packet identification (PID) errors. Figure 1 provides an example of the detail provided about IPTV transport stream quality.

Analyzer	IP Address	Port	Mbps	Tot. Pkt Loss	Pkt Loss	Pkt Jitter (ms)	Pkt Jitter Max (ms)
<input type="checkbox"/>	239.0.10.1	1024	6.37	0	0	0.000	0.000
<input type="checkbox"/>	239.0.10.2	1025	6.37	0	0	0.000	0.000
<input type="checkbox"/>	239.0.10.3	1026	6.37	0	0	0.000	0.000
<input type="checkbox"/>	239.0.10.4	1027	6.37	0	0	0.000	0.000
<input type="checkbox"/>	239.0.10.5	1028	6.37	0	0	0.000	0.000
<input type="checkbox"/>	239.0.10.6	1029	6.37	0	0	0.000	0.000
<input type="checkbox"/>	239.0.10.7	1030	6.37	0	0	0.000	0.000
<input type="checkbox"/>	239.0.10.8	1031	6.37	0	0	0.000	0.000

Figure 1. IPTV transport stream quality detail

Additional Ethernet and IPTV-Specific Test Features

Ethernet

- 10 Gb/s LAN/WAN Single-port
- 10 Mb/s to 1 Gb/s (electrical/optical) Single- and dual-port
- 850, 1310, and 1550 nm Wavelength
- PBB/PBT, Ethernet OAM, VLAN, Q-in-Q, VPLS, MPLS tunneling
- Layer 1 (L1) BER test
- L2 Multiple streams, L2 transparency, and traffic generation¹
- Layer 3 (L3) Multiple streams and traffic generation²
- L4 TCP/UDP stateful emulation, traffic blasting
- FTP/HTTP/Telnet connectivity and Throughput test
- RFC2544
- Optical power measurement
- Cable diagnostics

IPTV

- 10 Mb/s to 10 GigE line rate test for IPTV
- Single program transport stream (SPTS)
- Multiple program transport stream (MPTS)
- Video Explorer: up to 512 SPTS and 32 MPTS
- Bandwidth, packet loss, packet jitter
- Video Analyzer up to 16 SPTS and 1 MPTS:
 - PCR jitter, MDI (per RFC4445), continuity error bit, and error indicator bit
 - TR 101 290 priority 1 errors such as PID, PAT, and PMT
 - Loss distance and period errors (per RFC3357)
 - Results per transport stream, and per PID
 - Internet Group Management Protocol (IGMP) support

¹ Constant, bursty, ramp, configurable source and destination address, frame format, type field (for Digital, Intel, Xerox [DIX]), frame length (including jumbo and undersized), VLAN tag, pause frames, payload, utilization percent

² Configurable source and destination IP address, Domain Name Server (DNS) type, DNS server, transmit (TX) payload, type of service/differentiated services code point (TOS/DSCP), transistor-to-transistor logic (TTL), packet size length (34 to 1500 bytes), ping, trace route

Quality of Service Measurements Testing with Multiple Streams

The Multi-Services Application Module relies on multiple stream traffic generation, allowing users to emulate various types of traffic with the appropriate Class of Service (CoS) mappings and assess the impact of such traffic on the overall network design, as Figures 2 and 3 illustrate.

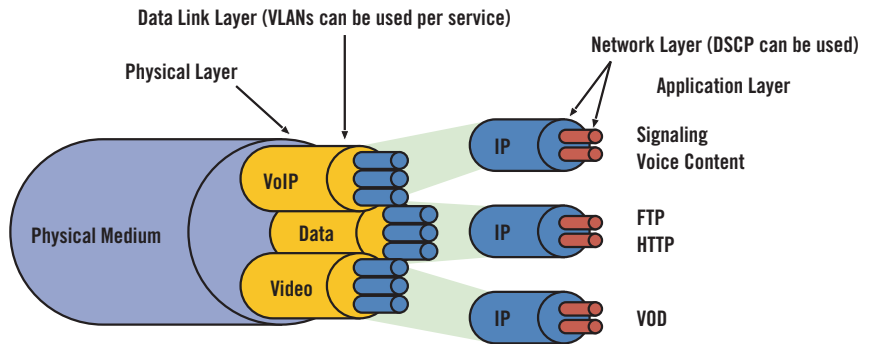

Figure 2. Multiple data streams

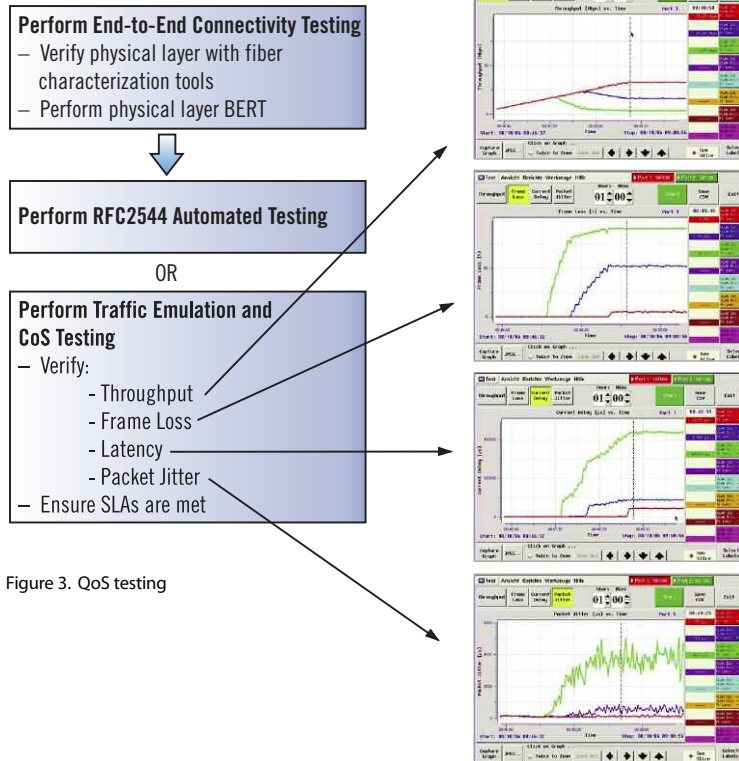

Figure 3. QoS testing

Application-Centric Layer 4 and Higher Turn-Up

The Multi-Services Application Module offers L4 and higher Application-Centric Turn-up that enables technicians to go beyond the traditional Ethernet service turn-up process that verifies the ability of the network to meet SLAs for L2 (Ethernet) and L3 (IP) performance. Upon completion of the basic connectivity and throughput testing, the Multi-Services Application Module Triple-Play Turn-up test application can be used to simplify the test and verification of ability of a network to carry Triple-Play Traffic. Users simply configure the desired number of representative standard definition (SDTV) and high definition (HDTV) television channels along with voice calls and data traffic, and the unit presents an easy-to-understand summary screen shown in Figure 4, including a network pipe diagram shown in Figure 5.

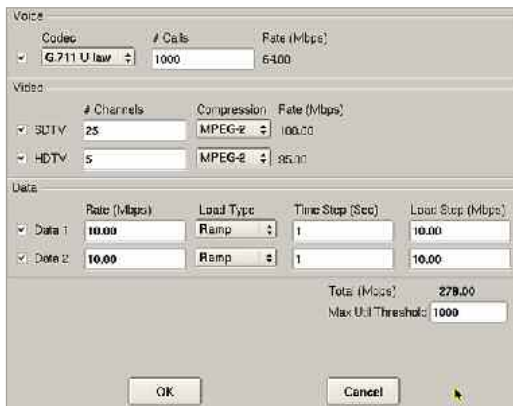

Figure 4. Configuring triple-play profiles



Figure 5. Triple-play summary network pipe screen

PBB/PBT, Ethernet OAM, VLAN, Q-in-Q, VPLS, and MPLS Tunneling Technologies

Various mechanism and tunneling technologies exist today that let providers effectively deliver carrier-grade Ethernet services across their networks, while maintaining a specified CoS. These technologies are grouped into categories:

- Native Ethernet protocol extensions (IEEE-based)—Virtual LAN (VLAN) tags (often referred to as 802.1q/p) and Q-in-Q (often referred to as VLAN stacking or 802.1ad) techniques
- Provider Backbone Bridged (PBB), Provider Backbone Bridged Transport (PBT), and Ethernet OAM Extensions (IEEE)
- Encapsulations by Multi-Protocol Label Switching (MPLS) networks, which also come in L2 (Virtual Private LAN Service, VPLS) and L3 versions

The Multi-Services Application Module enables the installation and maintenance of these technologies.

Scripts Automate TCP Window Optimization, FTP, and HTTP Throughput Testing

The Multi-Services Application Module automates the process of setting the TCP Window, which is critical to an application's performance. The Walk the Window script tests performance over a range of window sizes and provides an easy-to-understand test report that clearly highlights the optimal Window size. The Multi-Services Application Module also simplifies FTP and HTTP throughput testing with a wizard-like configuration interface. The FTP test results show FTP upload and download throughput for a wide range of file sizes. The HTTP throughput test is run with a live Web server and the test report highlights the Web page sizes versus throughput for each universal resource locator (URL).

Storage Area Networking

Fibre Channel/FICON Overview

The Multi-Services Application Module tests 1, 2, 4, and 10 Gb/s FC and fiber connection (FICON) services. Users can manipulate various fields of the FC frames to emulate end-customer traffic and perform BER measurements on L1 and L2 circuits. The Multi-Services Application Module supports buffer crediting capability, which lets providers verify the effect of delay on the link throughput and test the ability of the link to obtain the optimum buffer credit values. The Multi-Services Application Module also allows users to turn up storage area networks (SANs) efficiently using the FC automated test script producing reliable throughput, packet loss, RTD, and burstability results with a consistent test methodology. Figure 6 displays an example of a testing in a SAN.

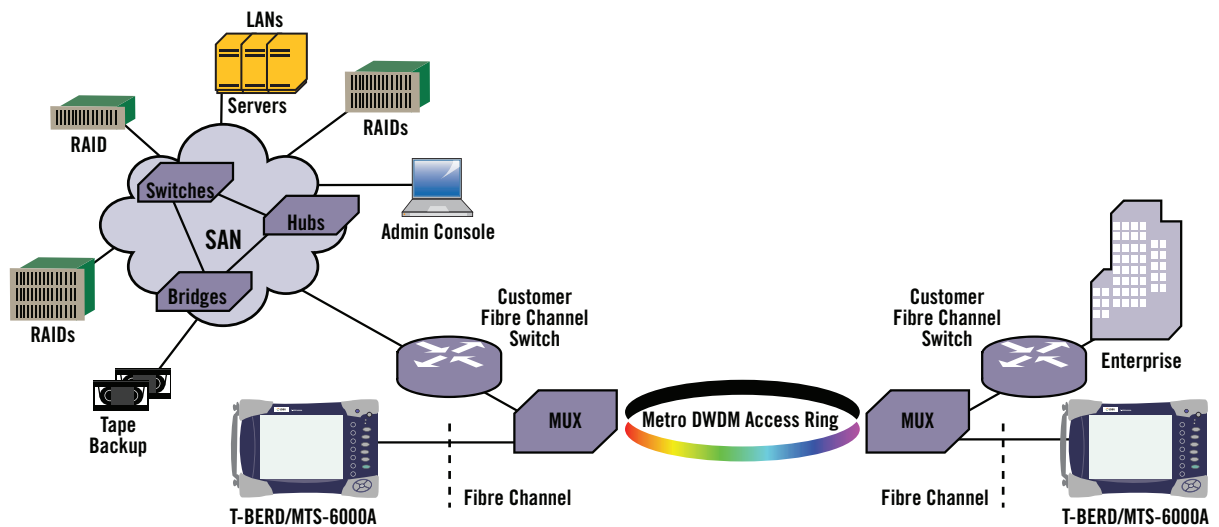

Figure 6. Storage area network

'RFC-like' Fibre Channel Testing

- Adapts RFC2544 testing methodology to FC circuits
- Allows for automated test routines and results analysis
- Allows for the saving of specific test configurations and routines

The Multi-Services Application Module provides an automated test routine and results analysis that can be configured to automatically verify the optimal buffer credit size to meet the desire SLAs of the link by:

- 1) Finding the optimal buffer size
- 2) Calculating the minimum buffer credit size for the specified throughput at each frame length (see Table 1)
- 3) Measuring throughput at various buffer credit sizes (see Table 2)

Frame Length (Bytes)	Cfg Rate (Mb/s)	Minimum Buffer Size (Credits)
76	1700.0	375
128	1700.0	278
256	1700.0	155
512	1700.0	83
1024	1700.0	43
1536	1700.0	30
2076	1700.0	22
2140	1700.0	22

Table 1. Buffer credit test limits

Frame Length (Bytes)	Buffer Size (Credits)	Cfg Rate (Mb/s)	Measured Rate (Mb/s)	Measured Rate (%)	Measured Rate (frames/s)
76	1	1700.0	4.1	0.24	4802
76	2	1700.0	8.3	0.49	9604
76	4	1700.0	16.7	0.98	19208
76	8	1700.0	33.1	1.95	38416
76	16	1700.0	66.3	3.90	76832
76	32	1700.0	132.8	7.81	153664
76	64	1700.0	265.5	15.62	307328
76	96	1700.0	398.3	23.43	460911
76	128	1700.0	531.1	31.24	614610
76	160	1700.0	663.7	39.04	768176
76	192	1700.0	796.5	46.85	921833
76	224	1700.0	928.2	54.60	1074402
76	256	1700.0	1060.8	62.40	1227849
76	288	1700.0	1193.4	70.20	1381315
76	320	1700.0	1326.0	78.00	1534774
76	352	1700.0	1458.6	85.80	1688229
76	375	1700.0	1554.0	91.41	1798528

Table 2. Throughput at incremental buffer credit size

Very Easy to Use

The graphical user interface (GUI) of the Transport Module makes it easy for even relatively inexperienced technicians to perform a broad range of tests, as Figure 7 shows. The screen displays test results stacked in layers on top of each other, with each OK indicated in green and errors indicated in red. Tabular results are provided in the form of graphs for easier understanding, such as throughput, frame loss, delay, and jitter presented as functions of time. Wizard-driven scripts now automate formerly complicated testing procedures. For example, the Walk the Window script automates the process of determining the proper TCP Send Window size. Scripts are also provided to determine FTP and HTTP throughput.

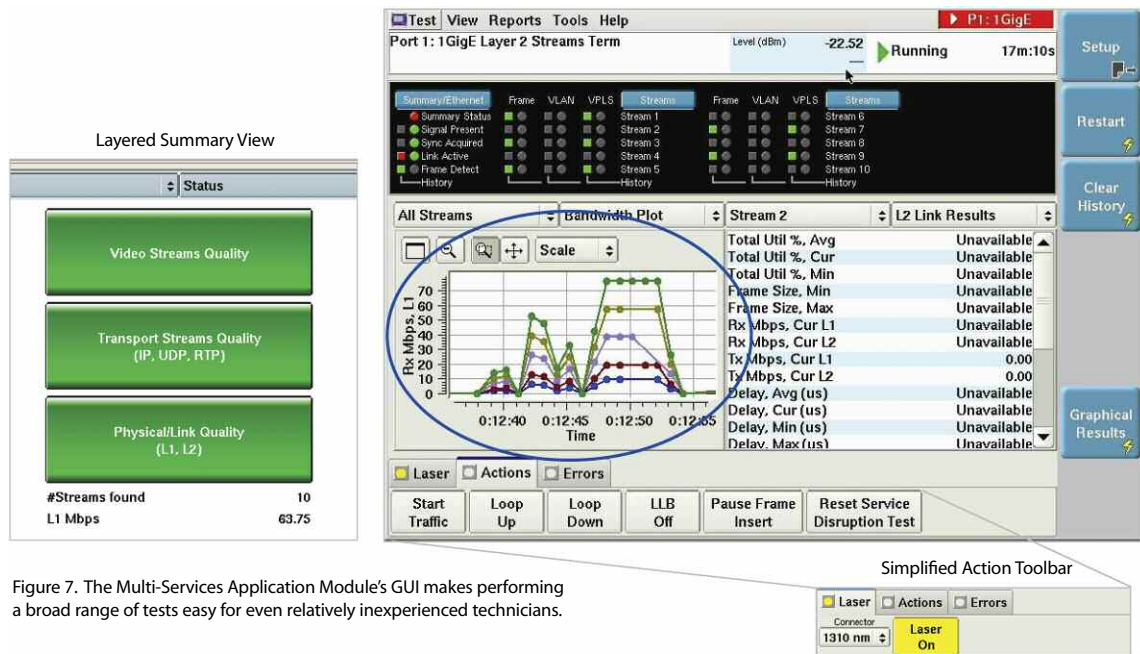

Figure 7. The Multi-Services Application Module's GUI makes performing a broad range of tests easy for even relatively inexperienced technicians.

SONET/SDH

1.5 M to 10 G SONET/SDH BER Testing

The Multi-Services Application Module performs BER testing on all line interfaces in end-to-end or loopback applications, inserts errors and alarms to verify NE conformance and connectivity, and measures BERs to ensure QoS.

SONET/SDH Overhead Byte Manipulation and Analysis

Using the overhead byte manipulation and analysis capability of the Multi-Services Application Module, users can modify K1 and K2 bytes to test automatic protection switching (APS) to specify and identify user-configurable path trace messages and payloads.

Service Disruption Measurements

The Multi-Services Application Module measures the protection switch times of SONET/SDH rings and their effects on tributaries. By measuring various error and alarm conditions on the tributaries, providers can verify that their transport network is providing adequate redundancy to guarantee SLAs, as Figure 8 shows.

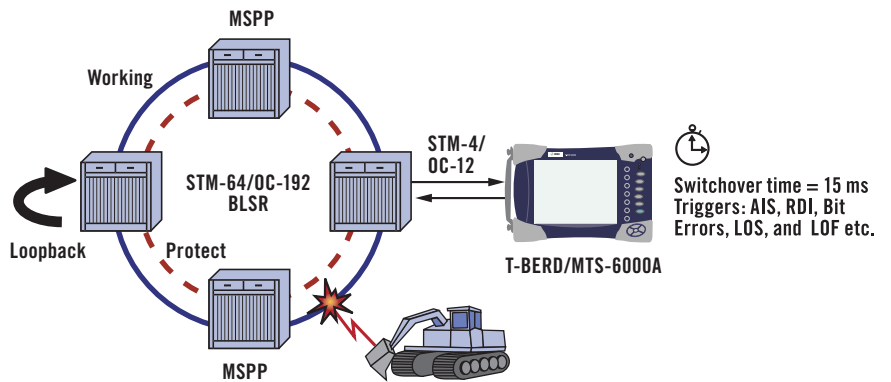

Figure 8. Service Disruption

OTN

The goal of the OTN, or digital wrapper technology, is to combine and accelerate the benefits of SONET/SDH with the bandwidth expandability of dense wavelength division multiplexing (DWDM). OTN applies the operations, administration, maintenance, and provisioning (OAM&P) functionality of SONET/SDH, which allows for protocol transparency; optimized, error-free transmission; and reduces the number of Reamplify – Reshape – Retime (3R) regeneration points in an optical network. This enables operators to cost-effectively install, maintain, and scale their next-generation networks. Figure 9 provides a view of the OTN frame.

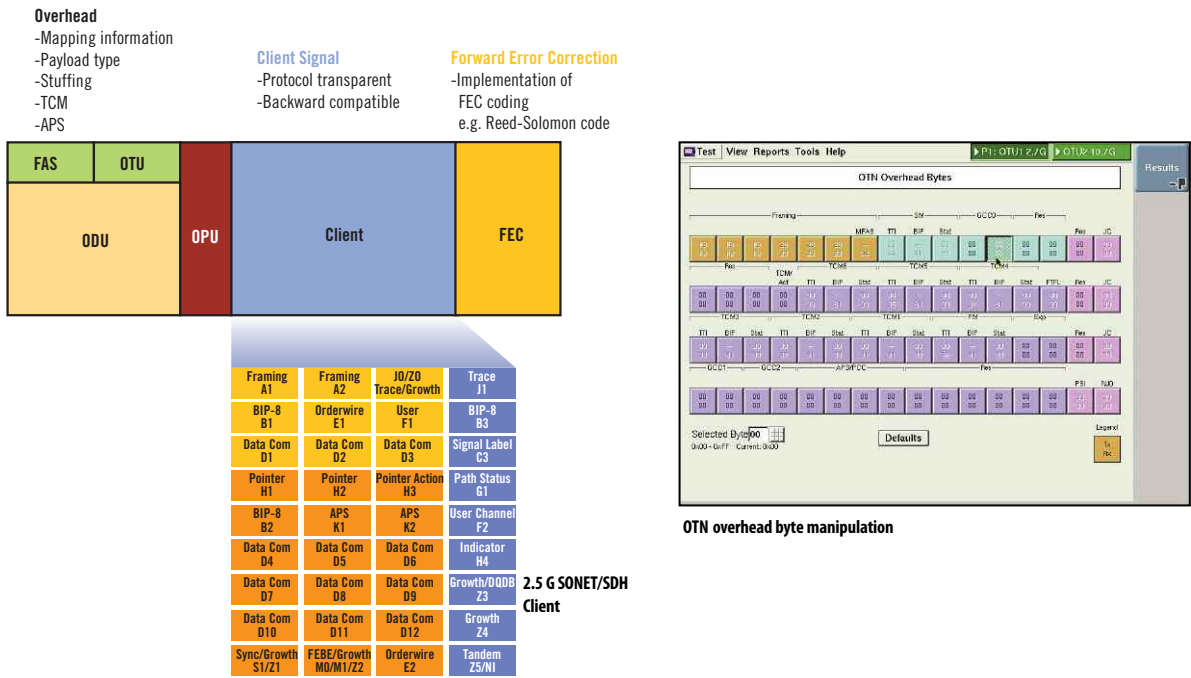

Figure 9. OTN Frame

Support OTU-1 (2.7 G) and OTU-2 (10.7, 11.05, 11.1 Gb/s) Optical Interfaces

- Test end-to-end connectivity by transmitting and receiving OTN (Reed Solomon [RS], 255/239) signals including a variety of client signals and pseudorandom bit sequence (PRBS) test patterns
- Save time by simultaneously and independently testing 11.1, 11.05, 10.7, and 2.7 Gb/s interfaces
- Emulate 10 GigE client within 11.1 and 11.05 Gb/s OTN interface
- Perform SONET BER testing within 2.7 and 10.7 Gb/s OTN interface

Transmit and Analyze Correctable and Uncorrectable FEC Errors

- Verify the ability of a NE to correct conditions through the use of forward error correction (FEC)-enabled signals

Fiber Optics

Faulty fibers and connectors continue to be the most common problems in today's transport networks. Even the smallest issue with the fiber plant can adversely affect high-speed transmission services. The T-BERD/MTS-6000A user interface module provides fiber test functionality without adding excess size or weight, eliminating the need to carry and manage separate test sets or additional modules. Never lose time due to faulty patch cords or optical connectors when turning up services.

High-Accuracy Power Meter and Source

Using the stable power source and high accuracy power meter of the T-BERD/MTS-6000A, users can measure power at any point in an active network, measure the insertion loss of a link between transmitter and receiver, and verify the loss characteristics of patch cords before turning up services. Providing this high-accuracy loss test set eliminates the need for a separate handheld instruments or additional test modules.

Visual Fault Locator

Considered a mandatory tool for technicians dealing with fiber patch cords, the built-in visible light source allows for quick fiber continuity checks and visual break locations.

Fiber Optic Microscope

Upon installation and maintenance of transmission systems, the optical inspection scope allows for the quality verification of the front optical connector during measurement or system turn-up. The use of the video probe allows for visualization of the connector in a safe environment, even if the fiber is active.

Additional Features and Applications

Numerous configurations and options are available for the T-BERD/MTS-6000A, including a dual test option that enables performing two independent tests in parallel; optical power source, high-accuracy power meter, optical time domain reflectometer (OTDR), chromatic dispersion (CD), polarization mode dispersion (PMD), and wavelength division multiplexing (WDM) test options that help identify fiber optic problems faster.

Specifications
General Specifications (Typical 25°C)
Display

Touchscreen, TFT color, 8.4 in LCD, 800 x 600, high-visibility

Storage and I/O Interfaces

Internal memory	1000 test results
Extended memory	Minimum 1 GB
2x USB V1.1, 1x RJ45 Ethernet	

Power Supply

Battery type	Standard removable Li-ion battery
AC/DC adapter	Input 100–240 V, 50–60 Hz
	Output 19 V DC/3.1 A
Operation time	Typical operation time is 3 hours, depending on the application

Size and Weight

Mainframe with one plug-in module and battery (l x h x w)	285 x 195 x 93 mm (11.2 x 7.7 x 3.7 in)
Mainframe only (without battery and module)	2.4 kg (5.3 lb)
Mainframe with one plug-in module and battery	4 kg (9 lb)

Environmental Specifications

Operating temperature range (no options)	–20 to +50°C (–4 to 122°F)
Operating temperature range (all options)	0 to +40°C (32 to 104°F)
Storage temperature range	–20 to +60°C (–4 to 140°F)
Humidity, non-condensing	95%

Base Unit Optical Interfaces (optional)
Power Meter

Power level	+10 to –55 dBm
Calibrated wavelengths	850, 1310, and 1550 nm
Connector type	Universal push/pull (UPP)

Talk Set

Wavelength	1550 nm ±20 nm
Dynamic range	>45 dB range
Function	With data/file transfer
Laser safety	Class 1M laser
Connector type	Field interchangeable

Visual Fault Locator (VFL)

Wavelength	635 nm ±15 nm
Output power level	<1 mW
Laser safety	Class 2 laser
Connector type	Universal push/pull (UPP)

Continuous Wave (CW) Light Source

Wavelengths (selection)	1310, 1550, and 1625 nm
Output power level	–3.5 dBm
Stability in 15 min	± 0.02 dB
Stability in 8 hrs	± 0.2 dB
Laser safety	Class 1M laser
Connector type	Field interchangeable

Video Inspection Scope (via USB)

Magnification	250X or 400X, through the USB port
---------------	------------------------------------

Ordering Information

Part Number	Description
-------------	-------------

Chassis

C0400	Single port 10 Mb/s to 2.5 Gb/s
C0404	Dual port 10 Mb/s to 2.5 Gb/s
C1000	Single port 10 Mb/s to 10 Gb/s
C1004	Dual port (one port 10 Mb/s to 10 Gb/s, one port 10 Mb/s to 2.5 Gb/s)
C1000LB	Single port 10 Mb/s to 10 Gb/s loopback only

Low Rate Interface Options

CT10M1GE	10/100/1000 Mb/s Elect Ethernet & 1 GigE Optical
CT25GSONSDH	OC-48/STM-16
CT622MSONSDH	OC-12/STM-4
CT155MSONSDH	OC-3/STM-1

High Rate Interface Options

CT10GELAN	10 GigE LAN
CT10GEWAN	10 GigE WAN
CT10GSONSDH	OC-192/STM-64

Additional Test Options

CTMPLSVPLS	MPLS/VP/LS
CTCOS	Multiple Streams/COS
CTIPVIDEO	IP VIDEO
CTLAYER4	Layer 4 TCP/UDP

Physical Interface Modules (PIMs)

CPSFP	SFP PIM
CPXFP	XFP PIM

GigE SFPs

CSFP-2G-8-1	SFP GigE and 2/1 Gb/s Fibre Channel, 850 nm, 300 m, SX
CSFP-2G-3-1	SFP GigE and 2/1 Gb/s Fibre Channel, 1310 nm, 20 km, LX
CSFP-2G-5-1	SFP GigE and 2/1 Gb/s Fibre Channel, 1550 nm, 80 km, ZX
CSFP-1G-CU	SFP 10/100/1000 Mb/s Copper RJ45

2.5 Gb/s & GigE SFPs

CSFP-2G5-3-1	SFP 2.5 – 2.7 Gb/s & GigE & 2/1 Gb/s FC, 1310 nm, 40 km, LR1
CSFP-2G5-5-1	SFP 2.5 – 2.7 Gb/s & GigE & 2/1 Gb/s FC, 1550 nm, 80 km, LR2
CSFP-2G5-5-2	SFP 2.5 – 2.7 Gb/s & GigE & 2/1 Gb/s FC, 1550 nm, 15 km, IR2

155 – 622 Mb/s SFPs

CSFP-622M-3-1	SFP 155 – 622 Mb/s, 1310 nm, 15 km, LR1
CSFP-622M-5-1	SFP 155 – 622 Mb/s, 1550 nm, 80 km, LR2

100 Mb/s SFPs

CSFP-100M-3-1	SFP 100 Mb/s, 1310 nm, 2 km, MM
CSFP-100M-3-2	SFP 100 Mb/s, 1310 nm, 10 km, SM, 10 Gb/s XFPs
CXFP-10G-8-1	XFP 9.95 Gb/s & 10 GigE & 10 Gb/s FC, 850 nm, 300 m, SR
CXFP-10G-3-1	XFP 9.95 – 11.1 Gb/s & 10 GigE & 10 Gb/s FC, 1310 nm, 10 km, SR1
CXFP-10G-5-1	XFP 9.95 – 11.1 Gb/s & 10 GigE & 10 Gb/s FC, 1550 nm, 40 km, IR2
CXFP-10G-5-2	XFP 9.95 – 11.1 Gb/s & 10 GigE & 10 Gb/s FC, 1550 nm, 80 km, IR2, APD

Accessories

CB-2216	SC-to-SC Cable, Single-Mode
CB-019967	LC-to-LC Cable, Single-Mode
CB-2002	FC-to-FC Cable, Single-Mode
CB-019965	LC-to-LC Cable, Multimode
CB-019011	SC-to-LC Cable, Single-Mode
CB-019013	SC-to-LC Cable, Multimode
CB-LCFC2M	FC-to-LC Cable, Single-Mode
CLC10DB	10 DB LC-LC Attenuator M-F Single-Mode
CLC15DB	15 DB LC-LC Attenuator M-F Single-Mode
CLC5DB	5 DB LC-LC Attenuator M-F Single-Mode

Test & Measurement Regional Sales

NORTH AMERICA TOLL FREE: 1 866 228 3762 FAX: +1 301 353 9216	LATIN AMERICA TEL: +1 954 688 5660 FAX: +1 954 345 4668	ASIA PACIFIC TEL: +852 2892 0990 FAX: +852 2892 0770	EMEA TEL: +49 7121 86 2222 FAX: +49 7121 86 1222	www.jdsu.com/test
---	--	---	---	--