

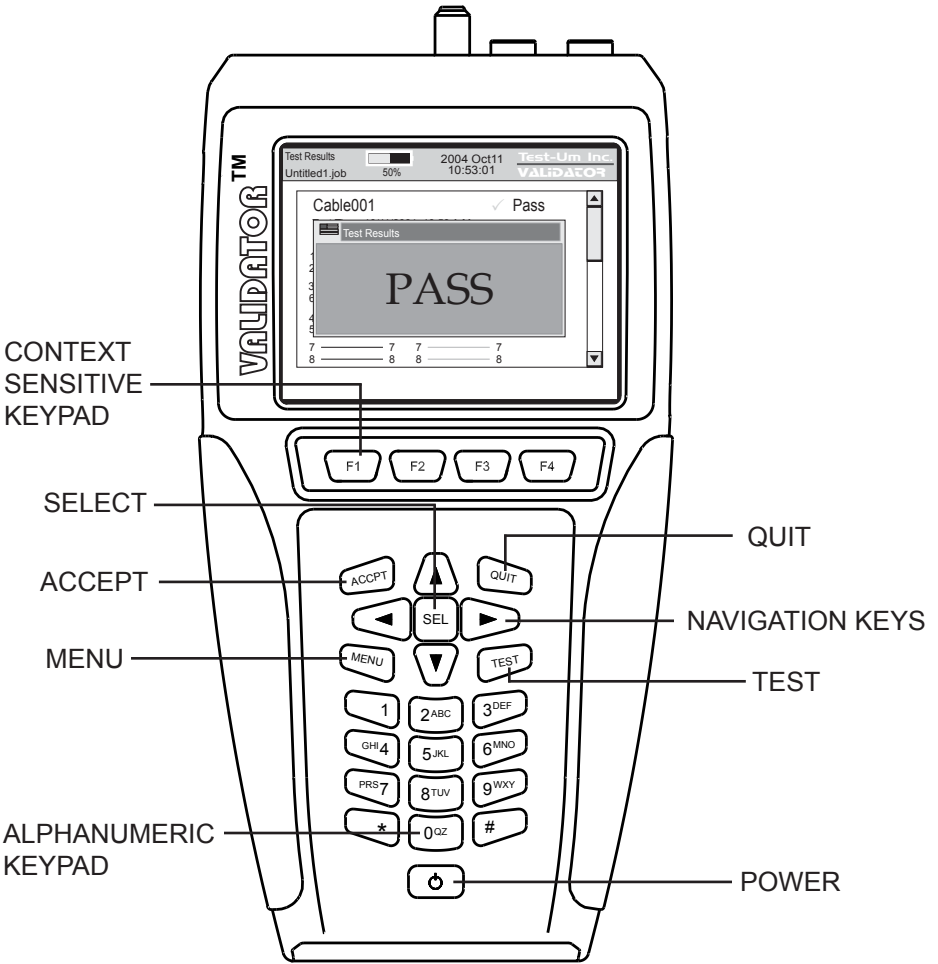

Validator™ Network/Cabling Certifier

www.jdsu.com/hbn

User's Guide



Congratulations!

You have just purchased the world's most advanced Speed and Performance Certifier. Your Validator is designed to give you years of reliable service with reasonable care. Remember these important Care Points.

- Re-charge the lithium-ion batteries fully when the Validator-NT is not in use. They do not have “memory” problems like older battery technology and are smart enough to know when they are full. Make sure you start your job with enough battery power to finish it.
- Keep your Validator clean with a damp soft cloth. Using cleaning agents can damage the poly carbonate lens over the LCD screen
- Clean spills and moisture from the Validator immediately. Do not allow the Validator to be submerged. Battery and display damage will result.
- Use the RJ45 Sacrificial Cable Modules (TP74) provided with the NT950 kit to prolong the life of your RJ45 data jack on your Validator main and remote unit. Replace these as necessary.
- Remember to register your Validator online immediately. You must register your product at www.jdsu.com/validator to download firmware and software updates and obtain access to other valuable support tools available on our web site.

Above all, enjoy your new Validator. It will make your testing life easier.

TABLE OF CONTENTS

Introduction	5
Ethernet Cable Certification	6
Plan-Um® Software	7
Test Ports and Cable Adapters	8
Registration	11
Support Information	12
Tests Performed	13
About Your Validator	14
Main Unit Features	14
Remote Unit Features	17
Standard Accessories	19
Optional Accessories	20
Menu Options & Navigation	21
Battery and Power Management	22
Validator Main Unit	23
Validator Remote Unit	24
Battery Lock Feature	25
Operations	26
1. Setting Up the Test Tool	28
1.1. Display Contrast	29
1.2. Printer Settings	30
1.3. Shutdown Timeouts	31
1.4. Set the Clock using the Real Time Clock Screen	32
1.5. Localization	33
1.6. Calibrate	34
1.7. Settings	35
2. Validator Properties	37
2.1. Battery Info	38
2.2. Product Version	40
2.3. Compact Flash Card Usage	41
2.4. Support Info	42
3. Managing Job Files	44
3.1. Creating A New Job	47
3.2. Creating Job Information	48
3.3. Creating Template Information	49
3.4. Using Template Files	50
3.5. Step By Step Instructions for Creating a New Job	51

TABLE OF CONTENTS

4. How Auto Test Works	53
4.1. Cable Test Schedule	55
4.2. Site Info	61
4.3. Contractor Info	61
4.4. Custom Cable Definitions.....	62
4.5. Job Utilities	65
4.6. Step by Step Instructions for Performing Auto Tests	66
5. Running Manual Tests	68
5.1. Data Cables	68
5.2. Phone Cables	70
5.3. 2-Wire Cables	71
5.4. Step by Step Instructions for Performing Manual Tests	72
6. Uploading/Downloading Jobs	77
6.1. Uploading the Cable Test Schedule to the Validator	77
6.2. Downloading Test Results from Validator to Plan-Um®	78
7. Archiving/Saving Test Results	79
8. Printing Test Results	80
9. Application Notes for Typical Field Use	81
9.1. New Job, New Cable Installations	81
9.2. New Job, Previously Installed Cables	81
9.3. Existing Job, Adds, Moves and Changes	82
10. Warranty	83
10.1. Shipping	84

Introduction

The Validator (NT900) Certifier uses Speed and Performance criteria to test and certify Ethernet network cables against IEEE802.3 specifications up to 1 Gigabit. It also tests critical noise and delay (Skew) measurements to assure that the respective cable runs will perform to their maximum capability. Breakthrough technology has made **Speed and Performance Certification** possible. It is the most up to date way of seeing the physical condition of the wiring and how a specific cable run will handle data flow on Ethernet speeds, 10 Megabit, 100 Megabit and Gigabit.

In addition to its state of the art 21st Century cable certification technology, Validator boasts a full selection of active network features designed to report cable performance and verify connectivity to network devices. These features include the ability to negotiate with network components and discover both the speed and configuration of connected equipment.

Ethernet Cable Certification

Speed and Performance Certification uses digital technology centered on the latest advances in Gigabit Ethernet Transceivers. These new highly integrated chips are capable of testing for noise in the network, faults in the cabling wiring and even generating live data packets that stress the cables to make sure they are able to support the equipment connected to them. This is the heart of the Validator Certifier.

To do **Speed and Performance Certification** Validator measures three specific levels of cable and connector conditions. Unless all three of these levels are tested it is impossible to accurately determine a cable run's capability.

1. Measure **TIA 568 Interconnect Specifications** such as Opens, Shorts, Miswires, Split Pairs and Reversals. The distance to faults and length of cable runs are accurately pinpointed with the use of both TDR and capacitance length measurement techniques. The Validator measures length up to a maximum of 1500 feet or 457 meters.
2. Measure **Pertinent Parameters** of Noise and propagation delay. NEXT, Return Loss, Attenuation, Amplitude and other noise factors are tested using Signal to Noise Ratio measurements. SKEW is measured using TDR (Time Domain Reflectometry) to insure acceptable signal time delay differences between pairs for Gigabit use.
3. Conduct a **Bit Error Rate Test**. **BERT** sends actual data packets down specified cable runs at defined data rates and quantities. Random code data is generated and checked for errors at the maximum throughput of the link, full duplex.

Plan-Um® Software

If the heart of Validator is a Gigabit Ethernet Transceiver then the soul of the Validator is the powerful planning and reporting software included in your test kit, Plan-Um®. Plan-Um® software ties the superior testing capability of the Validator with a simple to use software tool that helps organize the cable information and test results associated with your jobs.

Plan-Um® will help set up each job, define the scope of the job, aid in testing the individual cable runs accurately and produce an End of Job report that will tie in all the expectations of the installer and the customer.

Validator and the Plan-Um® software combine to close the loop on cable/network installations so that both the network user and the network installer can be confident of the physical properties of specific cable runs and the overall capability of the network in general.

Test Ports and Cable Adapters

Validator is equipped with four dedicated ports for testing data, telephone, coax, and 2-wire cable types.

Data Jack	RJ45 8-wire data interface
Telephone Jack	RJ11, 6-wire Telco interface USOC pairing
Coaxial Connector	“F” connector coax interface
Banana Jacks	2-wire testing

The Validator test kit is supplied with five cable assemblies designed to connect to the data, telephone, coax, and 2-wire ports of the main or remote Validator units.

- TP74 4” sacrificial cable with RJ45 connectors
- TP20 7.5” no fault cable assembly with RJ11 connectors for the RJ11 or RJ45 port
- TP55 12” shielded cable assembly with RJ45 connectors
- TP68 24” cable assembly with an RJ45 connector and 8 alligator clips
- TP62 Adapter, BNC plug to F jack

Note: It is recommended that you leave the TP74 Sacrificial Cables connected to prolong the life of the RJ45 network cable port of your Validator main and remote unit.

Data Cables and Connection



Figure 1. TP55 Connected to Validator

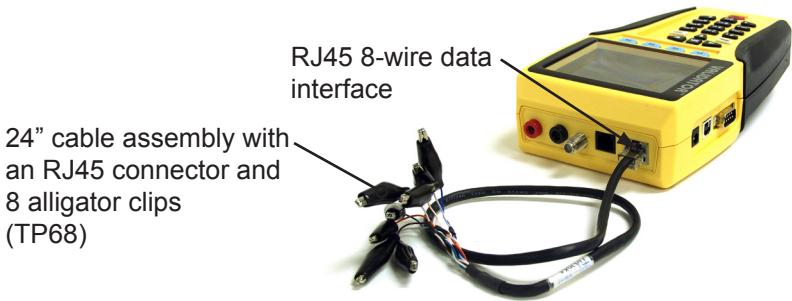

Figure 2. TP68 Connected to Validator

Telephone Cable and Connection

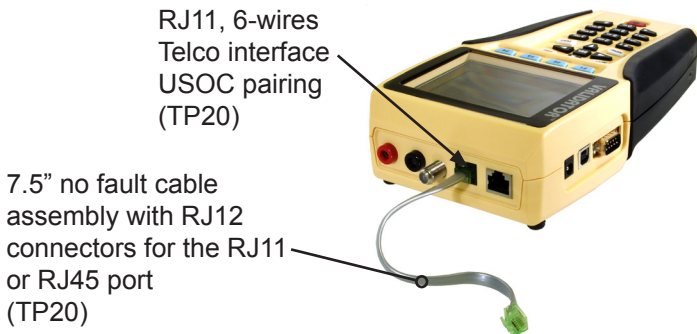

Figure 3. TP20 Connected to Validator

Two Wire and Connections



Figure 4. Video Coaxial Cable Connected to Validator

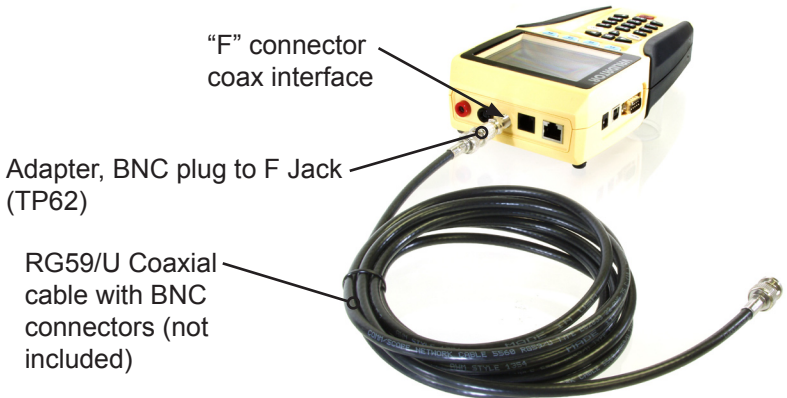

Figure 5. Security Cable Connected to Validator

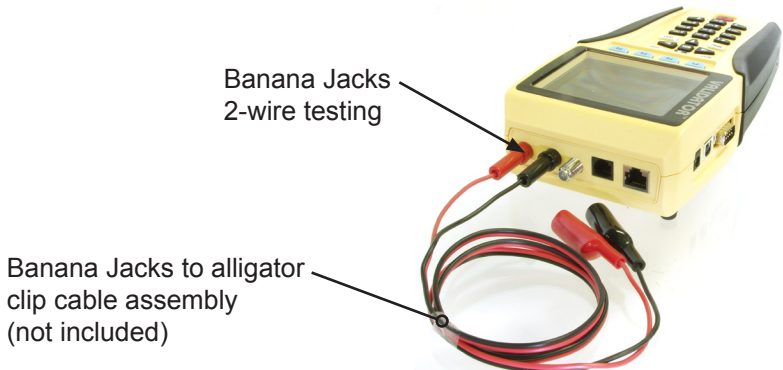

Figure 6. Banana Jack Cables Connected to Validator

Registration

You must register your product with JDSU to be eligible to receive firmware and software updates, as well as important product announcements, helpful hints and other support services. To register, go to our web site at www.test-um.com/warranty_form.asp and click on Warranty Registration.

Support Information

Post-sale Technical support is available Monday through Friday 8:30 am to 4:30 p.m, PST. Online technical assistance is available via our web site at www.jdsu.com/hbn.

Accessing the User's Guide Online

The NT950 User's guide is available at www.jdsu.com/validator. As product updates are released, revisions to the instructions will be posted to our web site.

Tests Performed

Validator performs specified tests that produce PASS or FAIL results on a wide range of standard cables. In addition, a Bit Error Rate Test (BERT) is performed to determine the actual speed capabilities of CAT 5, CAT 5E, and CAT 6 network cables. A green check mark with VoIP indicates the cable is certified to support a data rate of 100 Megabit or greater, which is a basic requirement for VoIP applications.

The following chart specifies the pre programmed tests that are performed on specific cable types (see figure 7).

Figure 7. Pre programmed Auto Tests for Specific Cable Types

Cable Types	Cable Mapping	Length	Shorted Pairs	Open Pairs	Split Pairs	Reversed Pairs	Distance to Short/Open	Signal to Noise Ratio (SNR)	Suggested Data Rate (Spec)	Bit Error Rate (BERT)
Data										
CAT5	X	X	X	X	X	X	X	X	X	X
CAT5E	X	X	X	X	X	X	X	X	X	X
CAT5 STP	X	X	X	X	X	X	X	X	X	X
CAT5E STP	X	X	X	X	X	X	X	X	X	X
CAT6	X	X	X	X	X	X	X	X	X	X
CAT6 STP	X	X	X	X	X	X	X	X	X	X
Phone										
CAT3	X	X	X	X	X	X	X			
CAT3 2P	X	X	X	X	X	X	X			
CAT3_4P	X	X	X	X	X	X	X			
2 Wire										
RG-6	X	X	X	X		X	X			
RG-58	X	X	X	X		X	X			
RG-59	X	X	X	X		X	X			
Fire	X	X	X	X		X	X			
Security	X	X	X	X		X	X			
Audio	X	X	X	X		X	X			
Tel_Cord	X	X	X	X		X	X			

In addition, the installer can define custom or nonstandard cable type test definitions. Once a Custom Cable Definition is created, you can create a Template File to store this information and retrieve it as needed.

About Your Validator

Main Unit Features

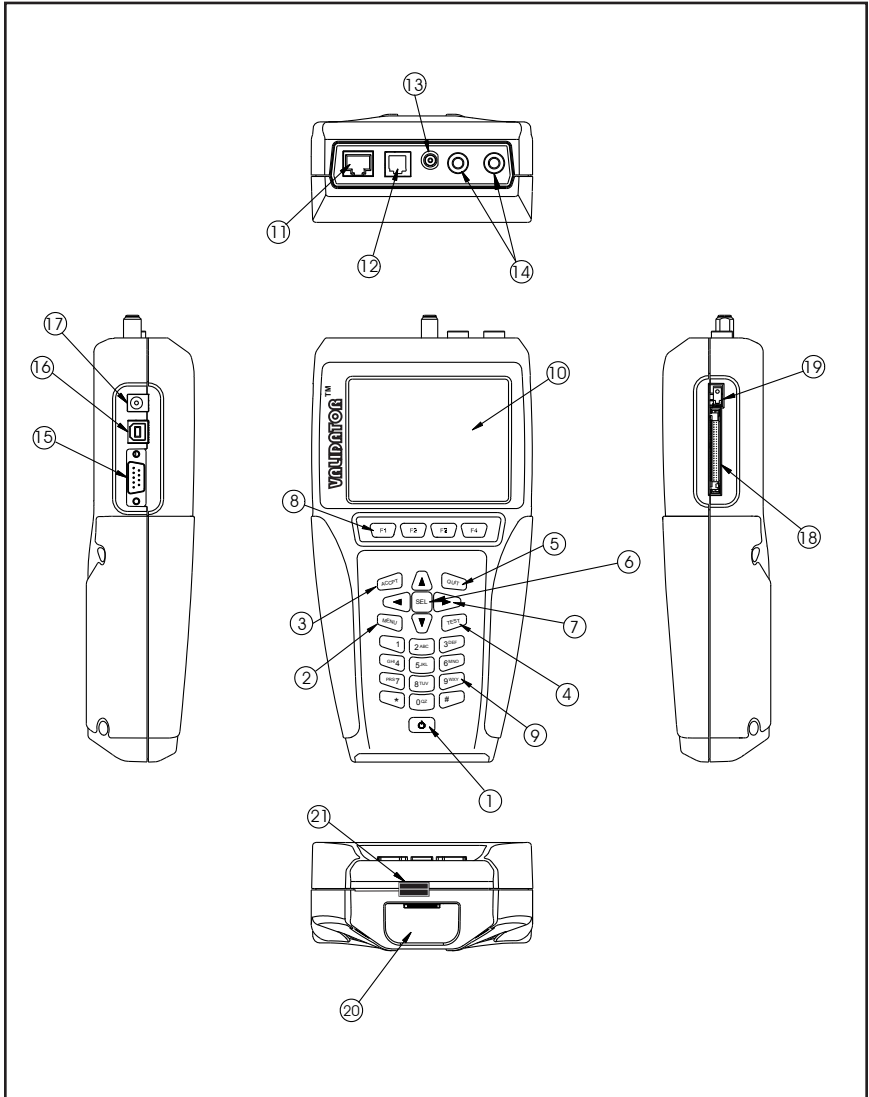

Figure 8. Main Unit Features

Table 1. Main Unit Features









Item	Feature	Description
1		<p>Power Key is pushed to power unit on/off. When unit is on a short tap changes the backlight from dim to bright. Holding key down for over a second turns the unit off.</p>
2		<p>Menu Key opens a shortcut window of simple functions.</p>
3		<p>Accept Key accepts the current selection or edited field.</p>
4		<p>Quit Key exits the current selections or moves backup in the menu sequence.</p>
5		<p>Test Key runs the automatic test sequence for the highlighted cable.</p>
6		<p>Select Key enables editing of currently highlighted field or activates the next level into the menu navigation sequence.</p>
7		<p>Arrow Keys are used for navigation of the active-selected field on the current menu.</p>
8		<p>Context Sensitive function keys enable the soft keys, which appear on the bottom of the LCD screen.</p>
9		<p>Alphanumeric keypad used to enter data. Pressing the 1 key multiple times displays the following special characters: @ () - . , and space. The (*) key is also a shortcut for the (.) period punctuation mark.</p>

Table 2. Main Unit Features (Cont.)

Item	Feature	Description
10	Display	4 inch LCD color screen.
11	Data Jack	RJ45, 8 wire data interface, T568A/B pairing.
12	Telephone Jack	RJ11, 6 Wire Telco interface, USOC pairing.
13	Coaxial Cable Connector	"F" Connector Coaxial Cable interface
14	Banana Jacks	Connection for 2-wire testing
15	Serial Port	Connection for serial port printer (Currently inactive)
16	USB Port	When computer is sensed connected to USB port, NT950 powers down and enters USB mode.
17	DC Power Supply	External power supply
18	Compact Flash Card	Standard data grade compact flash card. Only remove when unit is off.
19	Card Ejector	Folding ejector button. Fold over to prevent accidental ejection of the compact flash card.
20	Battery	Li-ion rechargeable battery (NT93)
21	Battery Lock	Sliding lever to secure battery

Remote Unit Features

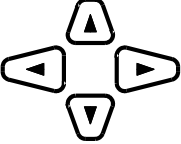
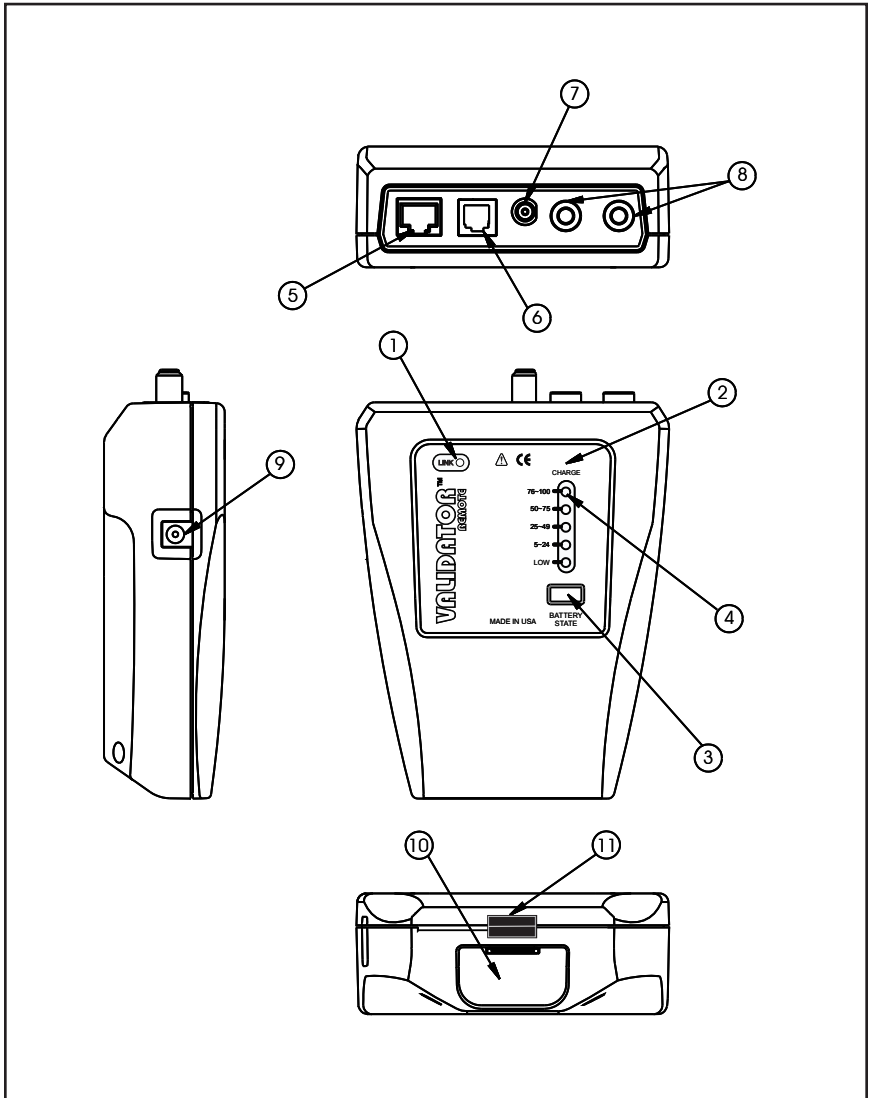

Figure 9. Remote Unit Features

Table 3. Remote Unit Features

Item	Feature	Description	
1	Link LED	Turns on when a link is established with another network device.	
2	Charge LED	Battery is charging when LED light is blinking.	
3	Battery state	When selected the battery life capacity is shown.	
4	Battery State Indicator	76-100 LED	Battery life capacity is between 76% to 100%, fully charged
		50-75 LED	Battery life capacity is between 50% to 75%
		25-49 LED	Battery life capacity is between 25% to 49%
		5-24 LED	Battery life capacity is between 5% to 24%
		LOW	Battery life capacity is low, and does need to be recharged.
5	Data Jack	RJ45, 8 wire data interface, T568A/B pairing.	
6	Telephone Jack	RJ11, 6 Wire Telco interface, USOC pairing.	
7	Coax Cable Connectors	“F” Connector Coaxial Cable interface	
8	Banana Jacks	Connection for 2-wire testing	
9	DC Power Supply	External power supply	
10	Battery	Li-ion rechargeable battery (NT93)	
11	Battery Lock	Sliding lever to secure battery	

Standard Accessories



NT900
Validator™



NT925
Validator™
Remote



NT930
Validator™
Carrying Case



NT940
Plan-Um®
Software



NT95
Cable Labels



Compact
Flash Card



(2) NT93
Lithium-ion
Rechargeable
Batteries



(2) NT92
AC Adapter,
Charger Units



NT94
72" Cable
Assembly, USB



(2) TP55
12" Cable
Assemblies,
Shielded RJ45
Connectors



(2) TP20
7.5" Cable Assemblies,
No Fault
RJ12 Connectors for RJ11
or RJ45



(2) TP68
24" Cable
Assemblies,
RJ45 with 8
Alligator Clips

Standard Accessories (Continue)



(2) TP62
Adapters, BNC Plug
to F Jack



(2) TP74
Sacrificial Cable for
Extending Modular Plug

Optional Accessories



NT935
Validator Main Unit
Carrying Case



TP610
Set of 8 Wiremap
Remotes

Menu Options & Navigation

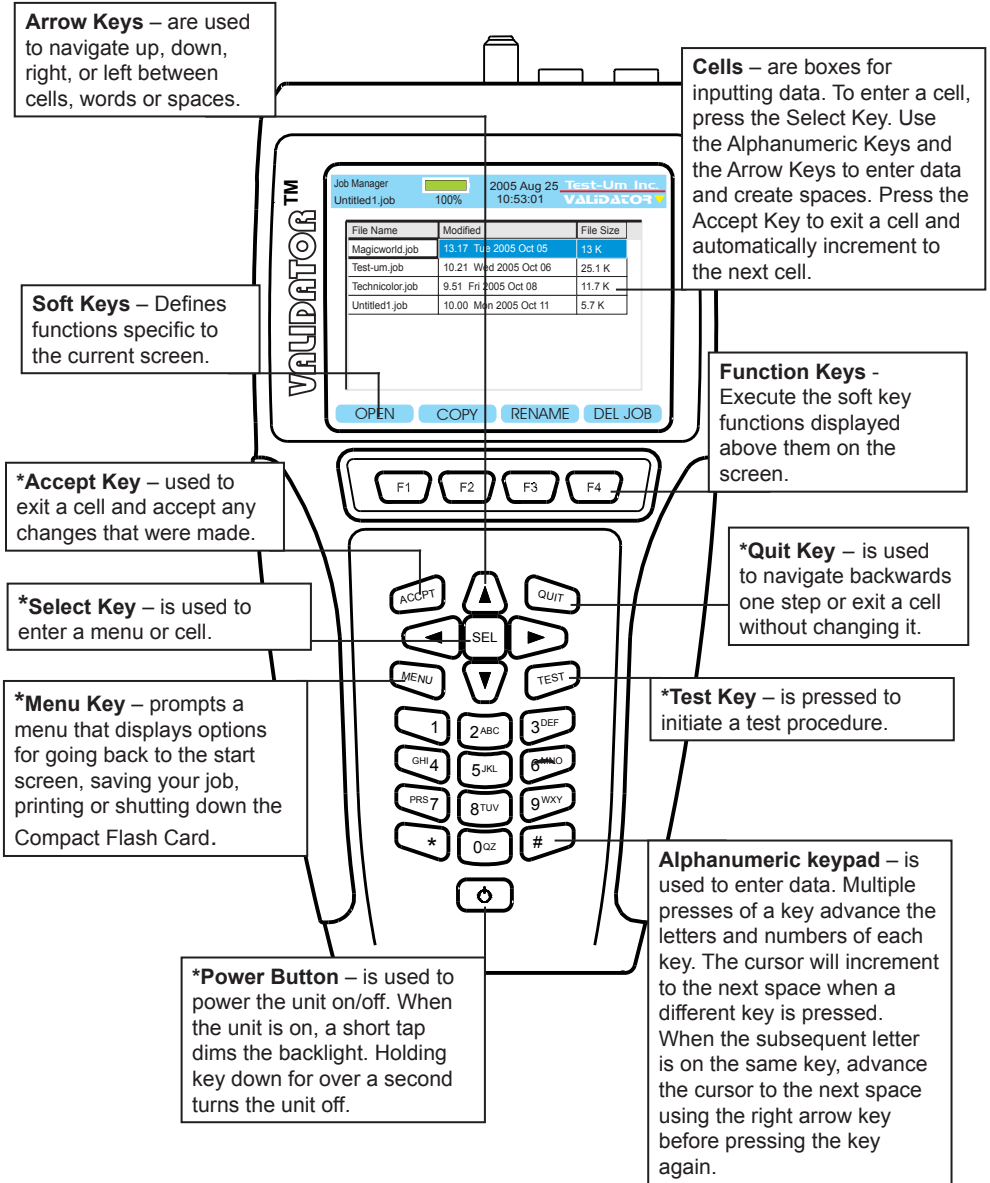

Figure 10. Keypad Navigation

Battery and Power Management

The lithium-ion rechargeable batteries (NT93) included with the Validator main unit and remote are recharged any time the Validator or remote are connected to the AC adapters included in the Validator kit. Use of other adapters, particularly car adapters, should always be avoided.

The batteries continue to charge during operation. The batteries included in the kit are designed to work with the Validator battery information system. They have the ability to store usage information that can be used to monitor the loss of capacity in the battery over time. Using other batteries of similar style will result in not knowing the battery condition or state of charge.

Each unit can run on battery power for approximately 8 hours. Since the remote uses considerably less power than the Validator main unit, a full days use can be assured by swapping the batteries between the two in the middle of the day.

A full recharge cycle takes approximately 2 ½ half hours.

The lithium-ion batteries for Validator can be used and stored in locations that do not exceed 122 degrees Fahrenheit (50 degrees Celsius) or 32 degrees Fahrenheit (0 degrees Celsius) limits. If the Validator senses an out of range condition while charging, it displays Hot or Cold below the battery symbol and suspends charging. The remote flashes the charging light rapidly and suspends charging for as long as the temperature is out of range.

Validator-NT will not be able to provide accurate test results if the AC power is not grounded properly. It is recommended that both the main unit and remote are operated on battery power during the cable tests.

<p>Note: Do not discard lithium-ion batteries in an area where they can be burned or in regular trash. Li-Ion batteries can explode if exposed to open flame and create hazardous waste. Dispose in a proper environmentally safe fashion.</p>
--

Validator Main Unit

When powered on, the Validator reports the charging status at the top of the screen under the battery icon. A green full battery icon indicates the battery is fully charged. As the battery discharges, the percentage of remaining charge is displayed in 10% steps. The battery icon changes from green to amber when the battery reaches approximately 30% of its charge capacity.

When the battery is Low, the battery icon will change to red and begin to flash. An audible warning tone will sound when the battery reaches LOW to notify the user that in approximately three minutes, the Validator will power down automatically and save the current job.

Note: The battery must be fully charged the first time it is used to report charging status. After one full charge, the batteries in the main unit and the remote unit are interchangeable.

If the battery is replaced, it is necessary to start a new charge cycle by either disconnecting the AC adapter momentarily or pressing the Reset Charge (RST CHR) soft key (F1) on the Properties/Battery Info screen.

In addition to the charging status, additional information that is useful to monitor the loss of capacity in the battery over time is displayed on the Battery Properties screen.

Charging will continue when the Validator is powered off but there is no visual indication. The Validator has various timeout conditions to conserve battery life. The specific timeout values are adjustable in the Setup, Shutdown Timeouts screen.

Validator Remote Unit

The Remote unit has a battery charge indicator light that is on solid during rapid charge, blinks slowly while topping off, or is off when charging is completed. The 76-100% light will be on to indicate a fully charged battery. The remote unit displays the percentage of charge remaining in 25% increments. If no lights are on while powered by an AC adapter, the battery is not inserted.

If the battery is replaced by another while topping off, it is necessary to press the Battery State button to initiate a new charge cycle. When operating from battery, a state of charge light is on whenever the remote is auto-powered on by the Validator or the Battery State button is pressed.

Although the display capability is limited on the remote, you can view the detailed charging information on the remote battery by inserting it in the main unit.

Battery Lock Feature

A Battery Lock feature on the main and remote Validator units is designed to prevent accidental ejection of the battery.

Apply pressure with your thumb to slide the Battery Lock lever across the channel to secure the battery in the locked position (see Figure 11) and in the opposite direction to unlock the Battery Release button (see Figure 12). Press the Battery Release button to eject the battery.

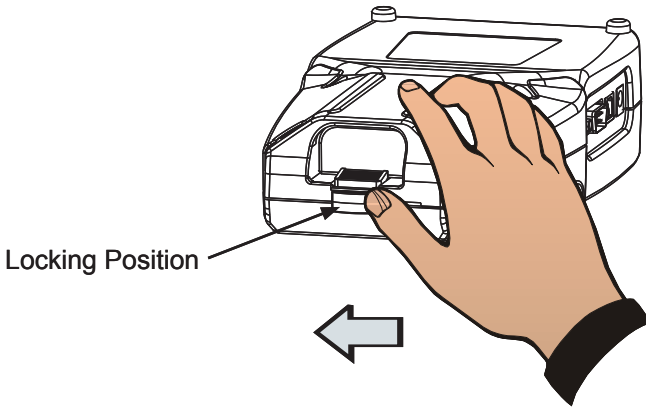

Figure 11. Battery Locking Position

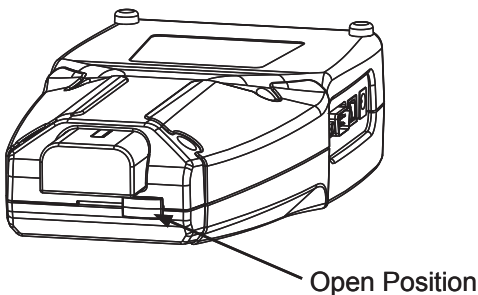

Figure 12. Battery Lock Open

Operations

The Validator main unit is powered on by pressing the red power button. When powering on, the unit will display a series of start up screens until the Start screen is reached, which contains the main menu. At the top of every screen the following information appears - The name of the screen being displayed “Start, Auto Test” etc., the current job name, the battery condition and the date/time from the internal clock.

The Validator always has a file open, which is the current file name that appears at the top of the screen, so that data can be saved in the event of auto-power down. The last job opened will remain as the current job until changed even through on and off cycles.

The Start screen has four buttons: **Auto Test**, **Manual Tests**, **Job Manager**, **Setup** and **Properties**. You can navigate between these buttons with the arrow keys that move from left to right on each row.

Auto Test

Selecting this button takes you to a menu of five functions used to work with existing jobs or create new jobs and test cables. Test Results are automatically saved and can be downloaded to Plan-Um® to document and archive the job.

Cable Test Schedule: Tests cables from a predefined job file or define-as-you-go Cable Schedule using Pass/Fail criteria.

Site Information and Contractor Information: View, edit or create this job information.

Custom Cable Definitions: View existing cable definitions and create or edit custom cables.

Job Utilities: File utilities used to create or manipulate job files.

Manual Tests

Select this button to test data, phone, or 2 wire cables without defining the job, cable name or type. The specified test is run and the raw results displayed without pass or fail criteria being applied. Manual tests cannot be saved as Auto Tests can.

Job Manager

The Job Manager displays a list of jobs that have been uploaded from the Plan-Um® software or have been created in the Validator and are on the CF card. By highlighting a job name and pressing the Open (F1) soft key you can select an existing job to test or edit the job information using the Auto Test menu functions.

Setup

This key takes you to internal adjustment functions of Validator such as Display Units, Display Contrast, internal time settings, Shutdown Timeouts etc. Normally these can be set once and left alone unless some specific change is desired. Each function has drop down dialog boxes for changes, if necessary.

Properties

This screen displays internal information on Validator such as Battery life, Compact Flash usage, revision levels, support phone numbers and web site support information etc.

1. Setting Up the Test Tool

The Setup menu allows the user to adjust internal functions such as Display Contrast, the internal time clock, English or Metric units, the displayed language, Shutdown Timeouts, Perform Response Tests, and Turn On Auto-Save. Most of these functions can be set once and left alone unless a specific change is desired. In addition, although currently not functional, future upgrades may permit the user to print Test Results directly from the Validator to a serial port printer.

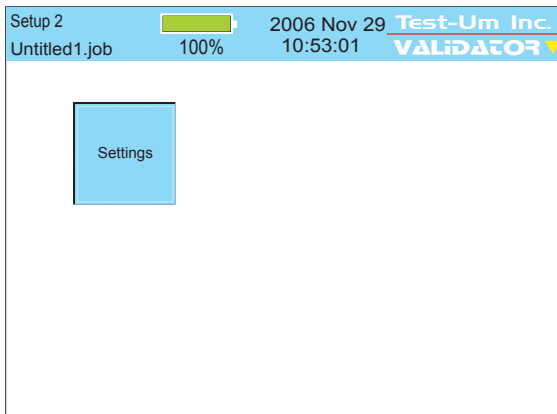
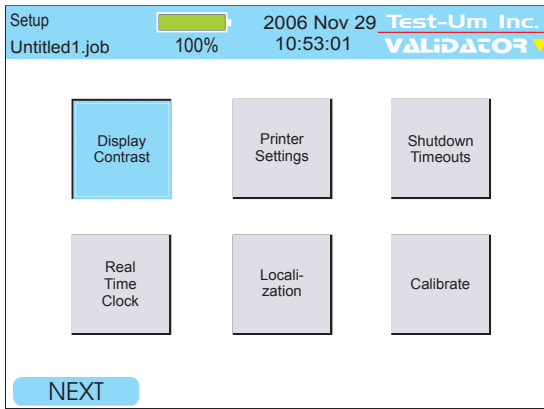

Figure 1.1 Setup Screen

1.1. Display Contrast

The Validator main unit allows contrast settings for different environments. Use the + (F1) soft key to increase the contrast for a dark environment or – (F2) soft key to decrease the LCD contrast in a bright environment (see Figure 1.2).

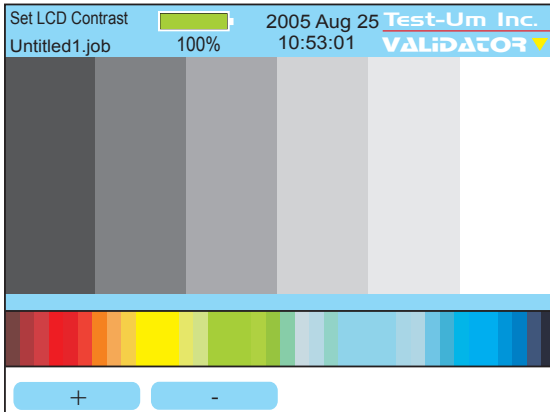

Figure 1.2 Display Contrast Settings

1.2. Printer Settings

Select Printer Settings (see Figure 1.3). A pull down menu appears which displays common Bit Rates for printers. The Bit Rate you select must match the Serial Port Printer properties of the printer you use.

Press Save (F1) to set and exit Printer Settings.

Use the serial port on the left side of the Validator to connect to the printer. A Cable Assembly is not provided.

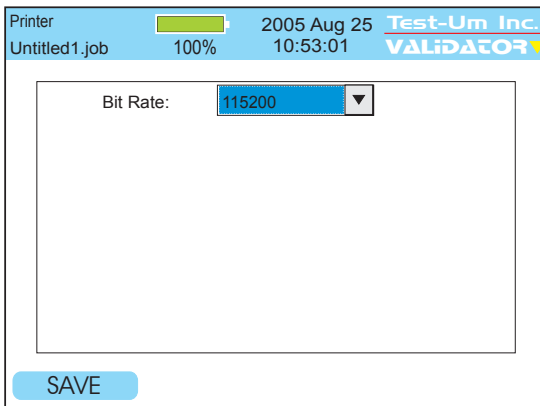

Figure 1.3 Bit Rate Settings for Printers

1.3. Shutdown Timeouts

A Power Save mode is installed in Validator to conserve battery life (see Figure 1.4). When the pre-set time limit is reached without any key input the main unit screen will begin to blink. Pressing any key will bring back the full screen and reset the timer.

Select preferences for the timeframes in minutes that you wish the Backlight, the Validator Operating System, and the Tone Generator to automatically shutdown and timeout in order to preserve battery life. Click the down arrow on each drop down dialog box and select the number of minutes desired before each function turns off. Press Accept, then press Set (F1) to initiate your selections and return to the Setup screen.

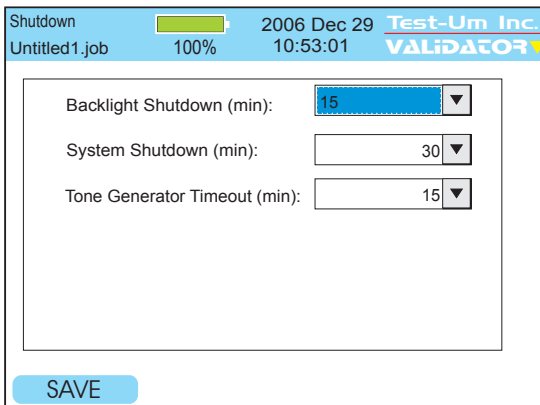

Figure 1.4 Shutdown Settings

1.4. Set the Clock using the Real Time Clock Screen

Using the drop down dialog boxes, select the current year, month, day, hour, and minute (see Figure 1.5). Press Accept to select your choice and move to the next field. Press Set (F1) to confirm your choices and return to the Setup Screen.

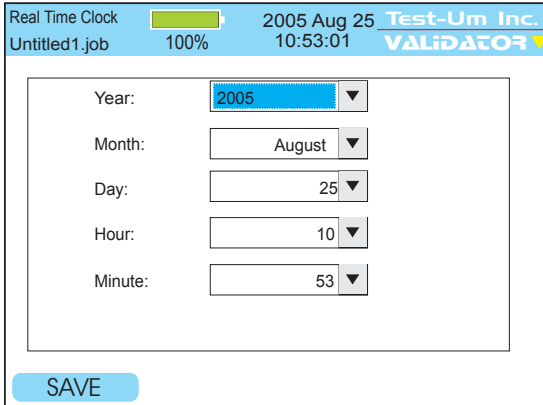

Figure 1.5 Real Time Clock Settings

1.5. Localization

Using the drop down dialog box, select Metric or English units to report length measurements (see Figure 1.6) to select the displayed language for Validator. Press Accept. Press OK to confirm your choice and return to the Setup screen.

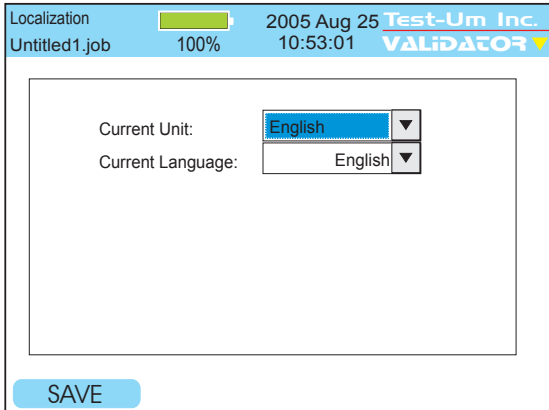

Figure 1.6 Localization Settings

1.6. Calibrate

The calibration procedure is performed to set a reference point for cable length to 0 feet/meters. Once calibration is performed, the test unit retains the information. The Validator does not require any other calibration. (Figure 1.7)

Note: Please disconnect all Patch Cables

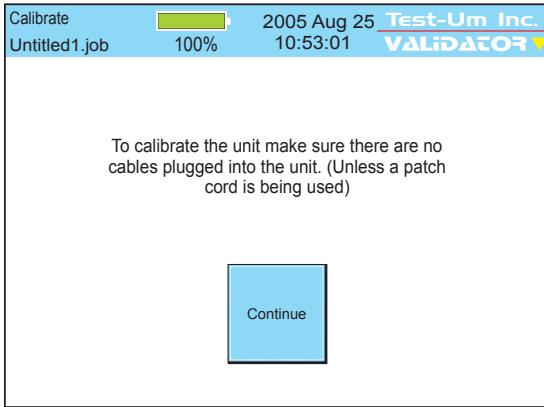

Figure 1.7 Calibrating The Unit

1.7. Settings

Currently, the settings button allows the user to be able to turn on and off the cable frequency response (attenuation) tests that are run during an auto test. In addition, the user can turn on and off the auto-save feature performed after each cable is tested. Using the drop down dialog box next to the label 'Perform Response Tests', select Yes or No to turn on or off the cable frequency response test during an 'Auto Test' (see Figure 1.8). Using the drop down dialog box next to the label 'Turn On Auto-Save', select Yes or No to turn on or off the auto-save feature performed after each cable test during an 'Auto Test' (see Figure 1.8). Press Accept to set the selection. Press OK to confirm your choice and return to the Main menu screen.

There are three different results that are generated and graph plotted during a cable frequency response (attenuation) test: Near-end Crosstalk (NEXT), echo (return loss) response, and channel response. These tests are un-calibrated approximations of the cable's attenuation and should be used for reference only.

Near-end crosstalk (NEXT) is defined as the unwanted signal coupling from a near-end transmitter into a pair measured at the same end. For the purposes of the NEXT test, Validator measures the 'B/C' dimension pairs. The first dimension pair 'B' indicates the transmit dimension (the dimension of the interfering signal). The second dimension pair 'C' indicates the receive dimension (the dimension onto which the interfering is coupled). Therefore, dimension 'B/C' represents the interfering signal from the dimension 'B' couple onto the dimension 'C' couple. Validator does not test all possible dimensions because most of the time the 'BC' dimension offers the worst-case approximation.

Echo response (return loss) is the ratio, measured in dB, at the junction of a transmission line and a terminating impedance or other discontinuity, of the amplitude of the reflected wave to the amplitude of the incident wave. For the purposes of the return loss test, Validator measures the 'B' dimension pair as it offers the worst-case approximation.

Channel response is the frequency dependent signal loss, measured in dB, created by the transmission of a signal at a specific frequency through the cable. For the purposes of the return loss test, Validator measures the 'B' dimension pair as it offers the the worst-case scenario.

Validator measures the signal loss of the dimension pair in the frequency domain. The sampling frequency of the NEXT and Echo cancellers in the PHY is 125 MHz and the channel equalizer is 250 MHz. The maximum frequency that can be represented is one-half the sampling frequency, therefore, the NEXT and Echo response frequency ranges are recorded from 0-62.5 MHz, and the channel response range is recorded from 0-125 MHz.

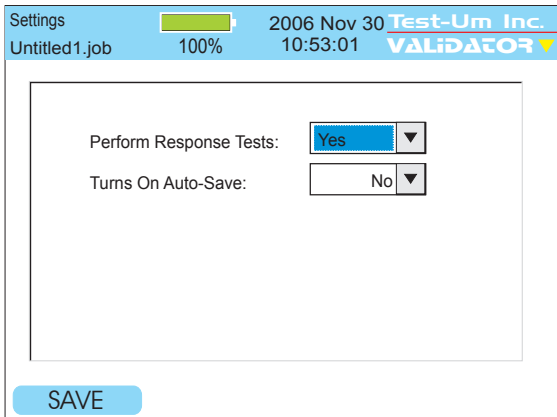

Figure 1.8 Settings

2. Validator Properties

The Properties menu displays buttons that contain internal information on the state of charge associated with the battery, product revision levels, available free space on the Compact Flash card, and JDSU support information. (Figure 2.1)

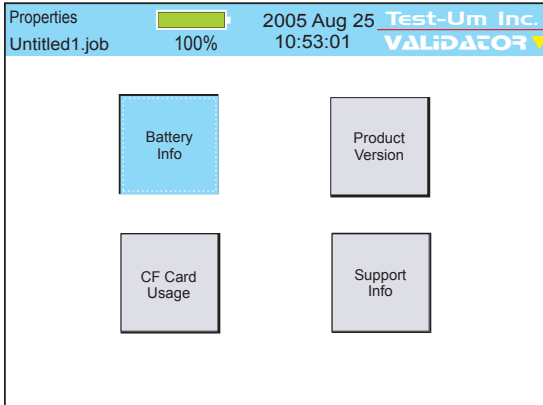

Figure 2.1 Properties Menu

2.1. Battery Info

This screen indicates whether the unit is operating on Battery Power or External Power and displays information that allows the user to monitor the remaining charge status and aging of the battery.

(Figure 2.2 & Figure 2.3)

Charge Remaining: Displays the percentage of charge remaining in percentages ranging from 0% to 100%. As the battery discharges, the percentage of remaining charge is reported in 10% steps.

Status: Reports the status of the charge cycle as Charging, Normal (temperature in range), Charge Cycle Complete, Automatic Shutdown Pending, Temperature Out of Range (too high or too low to charge), Cannot Read Battery Status, or No Battery.

Serial Number: Allows the user to identify a specific battery

Charge Cycles: Reports the number of times the battery charger completes the charge cycle.

Total Charge Accumulated: Tracks the amount of charge put into the battery.

The Battery Info screen also includes a Reset Charge (RST CHR) F1 soft key. The purpose of this function is to reset the charge cycle when you change out the battery. You can also start a new charge cycle by disconnecting the AC adapter momentarily.

The battery from the remote can be placed into the main unit and its properties can be viewed.

Note: For additional power and battery information see the Battery and Power Management section of this guide.

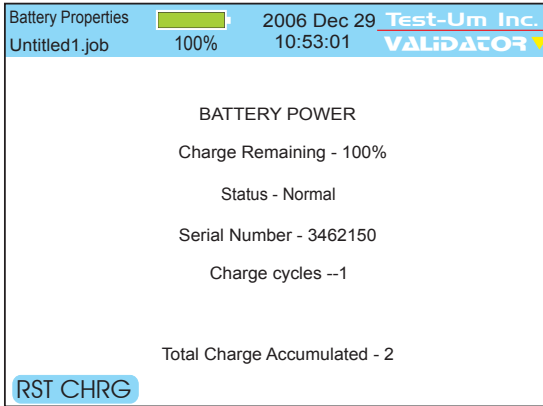

Figure 2.2 Unit Operating on Battery Power

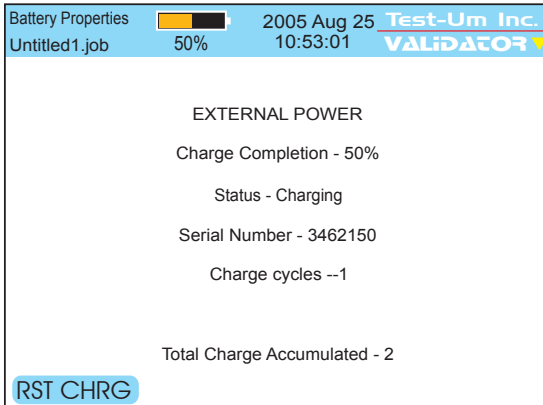

Figure 2.3 Unit Operating on External Power

2.2. Product Version

This screen displays the product’s electronic serial number plus the revision levels of the hardware, firmware and software in the Validator (See Figure 2.4).

Should you require technical assistance you may be asked to refer to this screen to confirm current product revision information. This screen will also be important in managing future product upgrades and updates.

Revisions		2005 Aug 25	Test-Um Inc.
Untitled1.job		100%	10:53:01
Component	Revision		
Serial Number	30745		
VAL_Batt	02.03		
VAL_Board	01.01		
VAL_Boot	01.05		
VAL_JFFS2	02.03		
VAL_PIC	02.11		
VAL_Root	02.01		
VAL_valapp	02.03		

Figure 2.4 Unit Revision Properties

2.3. Compact Flash Card Usage

The Validator kit includes a high quality mass storage compact flash card. Approximately 6000 cable tests can be stored per 32 Megabytes of card space. Press Select to view a pie chart that displays free card space with numeric values for percentage and kilobytes available (See Figure 2.5).

Validator requires compact flash cards that are intended for mass storage use and support both true IDE and PCMCIA interface modes of operation.

To remove the compact flash card while the unit is powered on, press Menu then CF Shutdown. The triangle at the top right corner of the screen changes from yellow to green. When it turns green, you can remove the flash card by gently pulling up and unlocking the ejector button and pushing it to eject the card.

To reinsert the card, place the contact side of the card in the slot and press gently to lock it in place. When the card is seated, gently pull up and press the ejector button into the locked position. A card must be in place in order to use the Validator.

Warning! Removing the compact flash card with the power on without using the CF eject function may cause data loss.

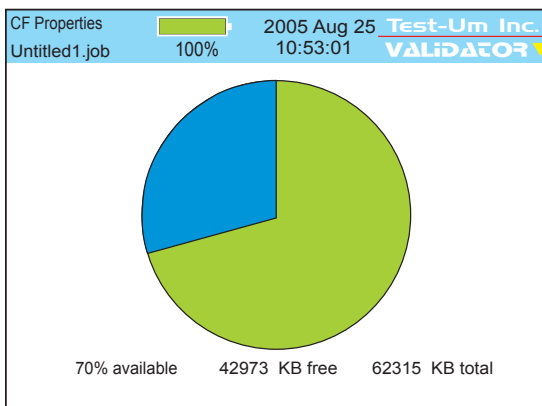

Figure 2.5 Compact Flash Card Properties

2.4. Support Info

The Support Screen displays Technical Support contact information, including our web site, telephone number, and e-mail address. The NT950 Technical Reference Manual is available at www.jdsu.com/validator.

In addition a blue box titled Manage Firmware displays which you will be able to select in the future to download product revisions from our web site. Specific update procedures will be included with the update file.

1. With the Validator powered off, connect the USB cable to your Validator and to the USB port on your PC.
2. Power On the Validator and a message appears “USB-File I/O Mode.” From the JDSU web site (www.jdsu.com/validator), select the downloads button and login. Follow the instructions to Download Firmware directly to the compact flash card.
3. Carefully remove the USB Cable after the file transfer has been completed following the instructions in Uploading/Downloading jobs.
4. Select Properties from the Start screen, then Support Info. (Figure 2.5)
5. Manage Firmware is already highlighted and can be accessed by pressing Select. A progress indicator will appear while the firmware files load.

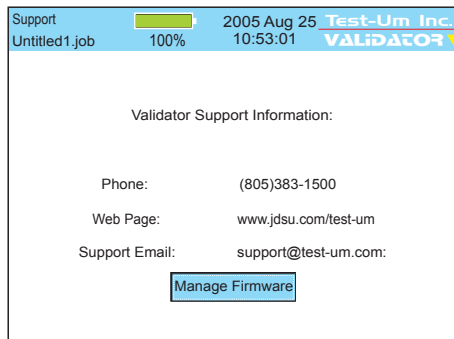

Figure 2.6 Support Information

6. Select the firmware file from the Firmware Package list. Press the Install soft key (F1) to install the firmware. (Figure 2.7)

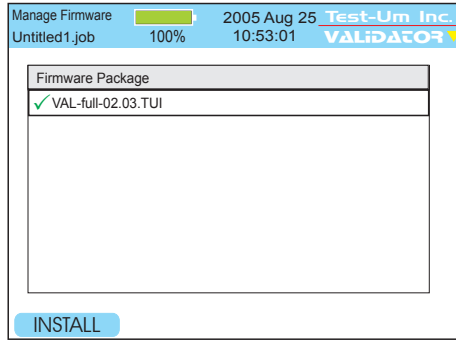

Figure 2.7 Firmware Manager

7. The Firmware Revisions screen will show the new revision in the Now column. It also shows the minimum revision level necessary for compatibility with the new component.
8. A Green check in the component column indicates the existing component is compatible with the new. A Red check signifies it is not. If this occurs, call JDSU support. Do not attempt to operate the Validator with incompatible files.
9. If all components have a Green check press Continue (F1) to begin the update process. Do not interrupt the update process that can take several minutes.
10. The Validator automatically reboots when the update is complete.
11. From the Properties screen, select Product version to verify all updates installed correctly.

3. Managing Job Files

The Job Manager screen is used to view a list of all job files stored on the compact flash (CF) card. Use the up and down arrows to highlight the job entry of interest. The soft keys are labeled with the functions that can be performed on the currently highlighted job: **Open, Copy, Rename, or Delete.** (Figure 3.1)

When the Validator is powered on, the current job (the last job opened in the Validator) displays in the upper left corner of the screen. This makes it easy to proceed directly to the Auto Test mode for that job. When you upload a new job, you must navigate to the Job Manager to view the list of all jobs and select the job you wish to open. If a job has never been created or opened, the current job will be “untitled1.job.”

Press the **OPEN** (F1) soft key to open the selected job. Opening the job will switch you to the Auto Test screen where the Cable Test Schedule displays all of the cable runs associated with the selected job.

Note: If there is unsaved data from the currently selected job, a pop-up window displays providing the option to save the current job.

The **COPY** (F2) soft key is used to make an exact copy of the highlighted job with a different name. This can be useful as a backup or as a starting point for another job that is similar.

The **RENAME** (F3) soft key is used to revise the name of the highlighted job.

The **DEL JOB** (F4) soft key will permanently remove the job from the CF card. A pop-up window asks you to confirm your request to delete the selected job. As a precaution, you cannot delete a job that is currently open. You must select and open a different job and then scroll to the job you wish to delete and press **DEL JOB**.

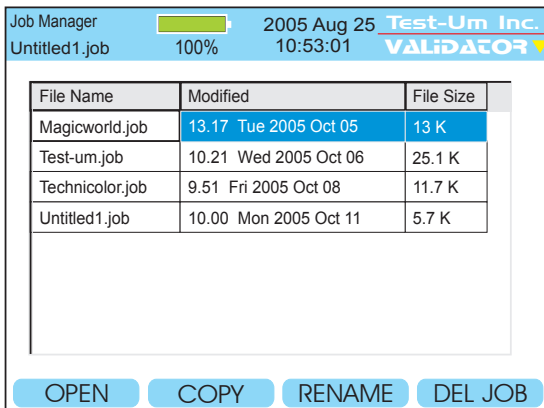

Figure 3.1 Job Manager

The Job Utilities screen provides the ability to create new jobs and template (*.Tut) files as well as the Save As function to save the current job information in memory under a different job name. From the Start screen, select Auto Test, and use the right arrow key to scroll to Job Utilities. The Save command on this screen is the same as the save in the Menu Window, which saves the current RAM memory contents to the currently loaded job's file.

In addition, this screen provides a shortcut to the Job Manager. Press Open to access a list of files stored in the Job Manager. (Figure 3.2)

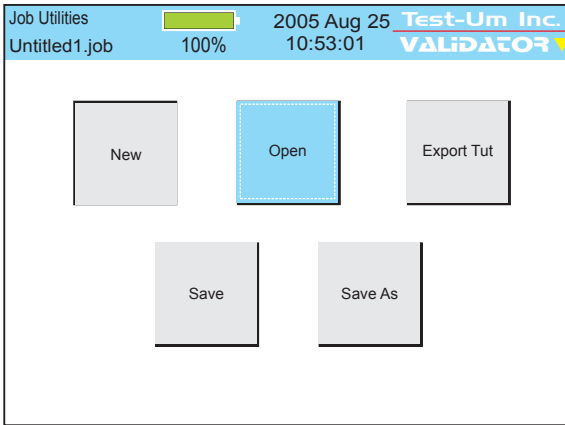

Figure 3.2 Job Utilities

3.1. Creating A New Job

Creating the job in Plan-Um® and uploading it to Validator is generally the quickest and easiest method of preparing your Cable List for testing. Only Test Results associated with a job can be saved and downloaded to Plan-Um® for printing and archiving.



Figure 3.3 Creating a New Job Flowchart

3.2. Creating Job Information

Job Information consists of **Contractor Information** and **Site Information**. Contractor Information identifies contact information for the company performing the job. Site information contains information about the site you are designing. (Figure 3.4)

Site and Contractor information prints on all job reports, and is used for bidding and invoicing.

1. Select **Auto Test** from the start screen.
2. Select **Site Info** or **Contractor Info** to enter into the screens.
3. Use the alphanumeric keypad to enter information into the fields. Use the **Backspace** (F1) and **Delete** (F2) soft keys to edit and delete data.
4. Press **Quit** to exit the screen when finished.

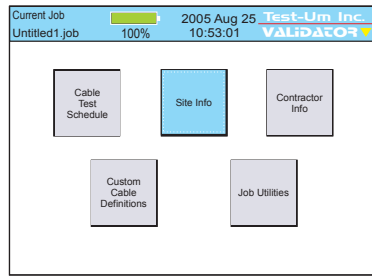

Figure 3.4 Creating Job Information

3.3. Creating Template Information

The purpose of the Template file (*.tut file) is to avoid reentering Company Information and/or Custom Cable Definitions for each job by saving the information in a Template that can be used on multiple jobs. You can also use an existing Job to create a Template.

JDSU recommends creating one or more reusable Template files (*.tut files) when you perform the initial setup on your Validator. Each time you create a New Job select the template that you created and make changes to the information as necessary.

The most efficient way to create templates is by using the Plan-Um® software. See the section of the Plan-Um® instruction booklet titled Managing Job Files/Save and Export As Template for complete instructions. Template files can be created and stored in Plan-Um® and uploaded to the Validator as needed, or created directly in the Validator.

1. To enter Template Information using the Validator keypad, select Auto Test on the Start screen. Enter the Contractor and/or Custom Cable Information that you wish to save as a template. Press Quit to return to the Auto Test screen.
2. Select Job Utilities and navigate to the Export Tut button.
3. Use the alphanumeric keypad to name the Template. Use the Backspace (F1) and Delete (F2) soft keys to edit the name as required. Press Accept to complete the name. Press OK (F3) soft key to save the template information under the name entered.

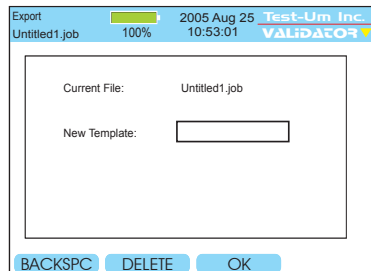

Figure 3.5 Exporting to a Template

4. The Template Information that you created contains contractor and/or custom cable information associated with the current job. You can use this template as is or edit the information when loaded into other jobs. You can also use an existing Job to create a Template.

3.4. Using Template Files

Each time you create a New Job, select a previously created template with Contractor Information and/or Custom Cable Definitions to avoid reentering information. (Figure 3.6)

1. From the Start screen, select **Auto Test**.
2. Using the arrow key, navigate to **Job Utilities** and press Select.
3. On the Job utilities screen, select **New**.
4. Enter a name for your job in the Filename box using the alphanumeric keypad. Press Accept. You must create a Filename. If you do not create a new Filename a Warning Message appears advising that the “Filename is empty.” Press OK to go back and create a Filename for the job.
5. Press Select to display the existing template files.
6. Select a template that has been previously created or select Default for a blank template.
7. Press OK (F3) when finished. Your new job that has been created will be your current job.

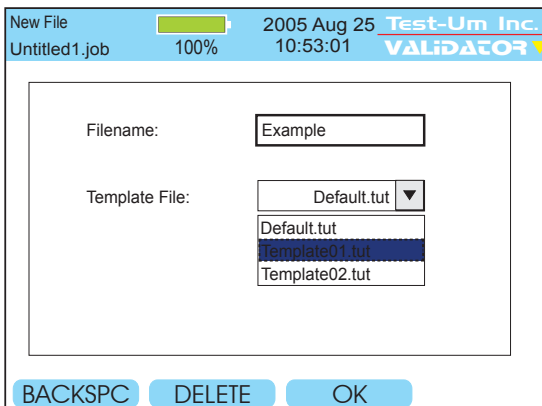

Figure 3.6 Selecting a Template File

3.5. Step By Step Instructions for Creating a New Job

1. From the Start screen, select **Auto Test**.
2. Using the arrow key navigate to **Job Utilities** and press Select.
3. On the Job Utilities screen, select **New**.
4. Enter a **Filename** using the alphanumeric keypad. (Figure 3.4) Press Accept. Depress the respective key multiple times to scroll through the alpha and numeric options. If the subsequent alphanumeric character is on the same key, you must use the right arrow key to navigate to the next space. When the subsequent letter is on a different key the cursor automatically advances to the next space. The number one (1) key contains the following special characters: @ () - . , space The Filename you create will reside in the Job Manager.
5. You must create a Filename. If you do not create a new Filename a Warning Message appears advising that the "File name is empty". Press OK to go back and create a Filename for the job.
6. Select a **Template** on the New File Screen. The default template is blank. If you have previously created a Job Info template with your company contact information, press the down arrow and select it now. Press Accept to confirm your selection.
7. Press the OK (F3) soft key.
8. The Auto Test screen appears. Using the arrow keys navigate to the Site Info button.
9. Enter Site Info using the alphanumeric keypad. Press Accept to advance to the next field.
10. If you have selected a template with your company information, it will automatically appear in the Contractor Info field. If you have not selected a template, enter Contractor Info using the alphanumeric keypad. Press Accept to complete each entry field.

11. When all fields have been completed, press Quit. The Auto Test screen reappears.
12. Select Cable Test Schedule. Using the alphanumeric keypad create a Test Schedule by completing the Cable ID field and selecting a Cable Type from the drop down menu. The To and From fields are optional information. The Result field is automatically populated when tests are run on that cable.
13. Proceed to Test by connecting the appropriate cable assembly.

4. How Auto Test Works

Creating the Cable Test Schedule in Plan-Um®, uploading it to the Validator, and running Auto Test is the easiest and most efficient way to verify cables. See the Uploading/Downloading Jobs section of this manual (or the Plan-Um® Software Instructions) for detailed instructions on how to upload and download job information and test results between Plan-Um® and the Validator.

When you have uploaded a job from Plan-Um® to the Validator-NT main unit, the job will appear in the list on the **Job Manager** screen. To run an existing job, you must first open it from the Job Manager before using it with Auto Test.

When you open a job, the Auto Test screen appears. This screen gives you five options: **Cable Test Schedule, Site Information, Contractor Information, Custom Cable Definitions and Job Utilities**. See Figure 4.1 for a Flowchart of the Auto Test process.

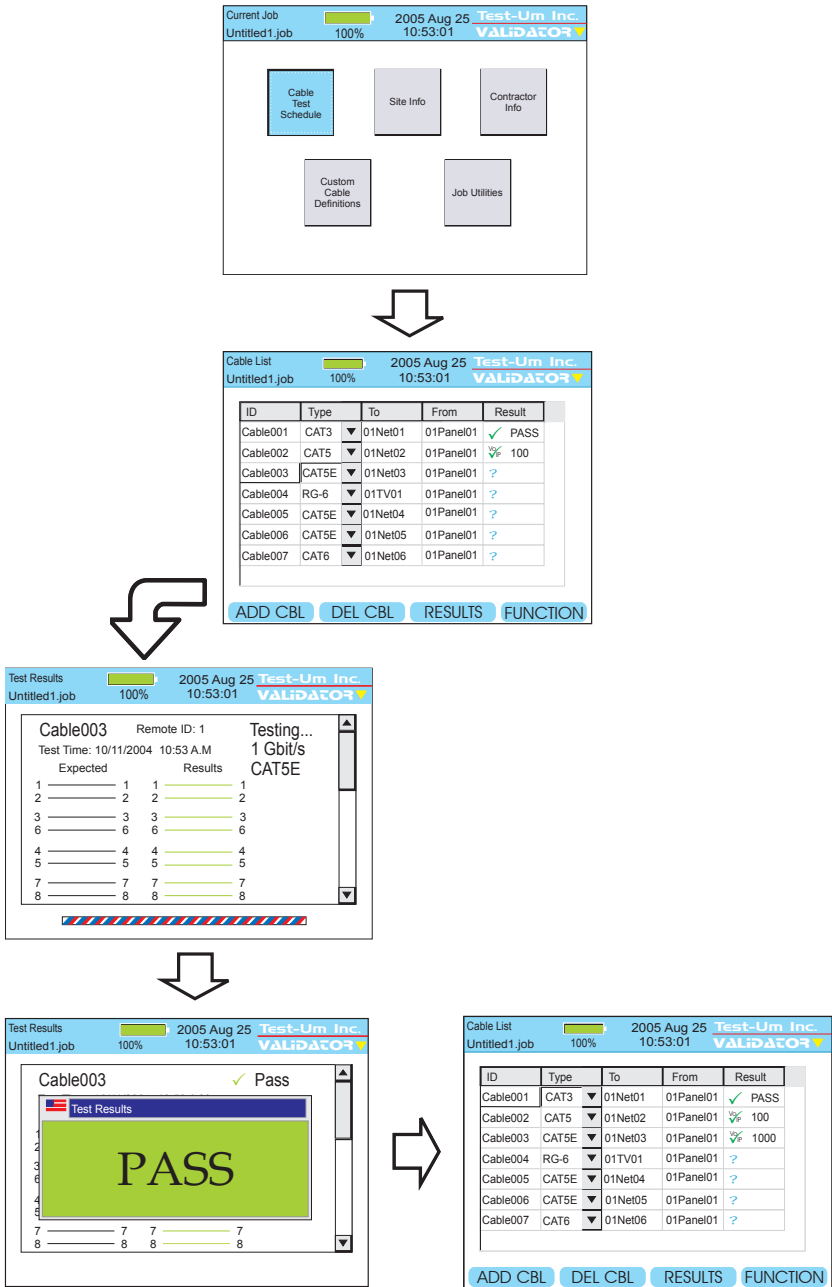

Figure 4.1 Auto Test Flowchart

4.1. Cable Test Schedule

The Cable Test Schedule displays all the individual cable runs associated with the open job. To test a cable on the list, highlight the Cable ID you wish to test. Attach that cable to the appropriate connector on the main unit. Attach the remote unit to the other end of the cable you wish to test.

With the remote connected to the cable, the test function can be started. Press TEST (See Figure 4.2). You will hear relays switching in the main unit and remote. A link is established with the remote, and Validator-NT begins testing the cable to the parameters that have been defined for its type. If it is a data cable, Validator-NT will perform full Signal-to-Noise Ratio and Skew testing as well as Speed testing with a Bit Error Rate Test (BERT). If the Frequency Response test setting is turned on (see Section 1.8), then the Auto Test will perform the NEXT, Echo, and Channel response tests as well.

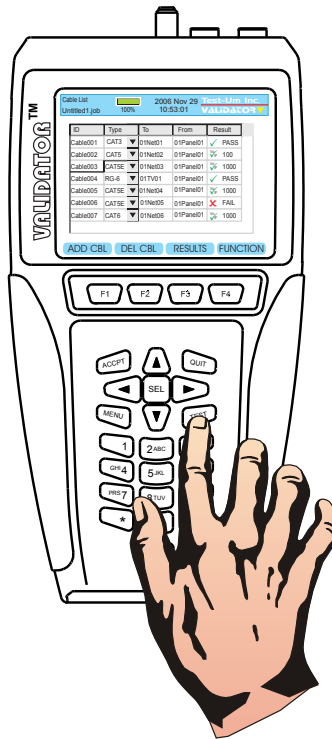
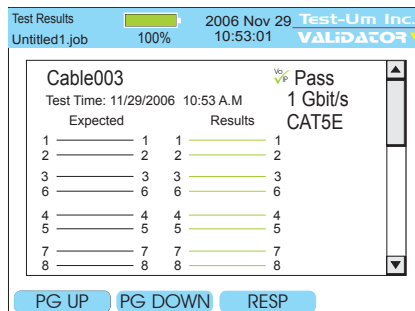

Figure 4.2 Test Button

A **PASS** or **FAIL** indication will be briefly displayed along with a speed rating up to 1 Gigabit depending on the cable type. The screen will show the Remote ID, wiremap of the individual pairs, and automatically scroll down to display Length, Skew, SNR and BERT test results. The lights on the remote unit flash sequentially to indicate a PASS condition. The job file is saved after every Auto Test.

Then the Cable Test Schedule displays the results and the test highlight automatically increments to the next cable in the list. The Voice over IP icon (VoIP) displays if the cable test results indicate a speed rating of 100MB or greater. You can go back to the previously tested cable by using the arrow navigation buttons and the Results soft key (F3) to inspect the specific test measurements, the speed test results, and the wire map conditions of each individual pair on the cable. Use the Arrow keys to scroll down this screen. Use the Response (RESP) soft key (F3) to view the graph plot of the NEXT, Echo, and Channel response measurements for the cable.



Additional Cable Test Schedule Features: To incorporate the need for more function keys on the Cable Test Schedule screen the F4 button toggles between two sets of operations. In the first set of operations the F1, F2 and F3 keys are used for add cable, delete cable and view cable test results respectively. In the second set of operations the F1, F2 and F3 keys are used for page up, page down and sort. The menu for the Cable Test Schedule screen has choices for viewing more details about the cable. In addition to cable details there are tools to navigate the Cable Test Schedule which prove useful when there are many cables in the job.

The Cable Test Schedule can be sorted by any column in ascending or descending order. To sort the Cable Test Schedule, move the highlight to a cell in the column to be sorted and press the SORT (F3) soft key. The column is sorted first in ascending order. A second press sorts by descending order and toggles between the two on subsequent presses.

Cable Frequency Response Plot: The cable frequency response plot data consists of three types of cable loss data measured in decibels in the frequency domain: Channel Response (the signal loss associated with frequency dependent channel characteristics), Echo Response (the signal loss associated with reflected signals), and Near-End Cross Talk (the signal loss associated with noise generated by signals carried on other cable pairs). The data is measured using Validator and stored in the job file for each cable tested.

The Frequency Response Plot depicts each cable's channel response, echo response and near-end crosstalk (NEXT). The plot is measured in decibels (dB) over the frequency domain (MHz). The channel response plot is drawn in green, the echo response in yellow and the NEXT in red.

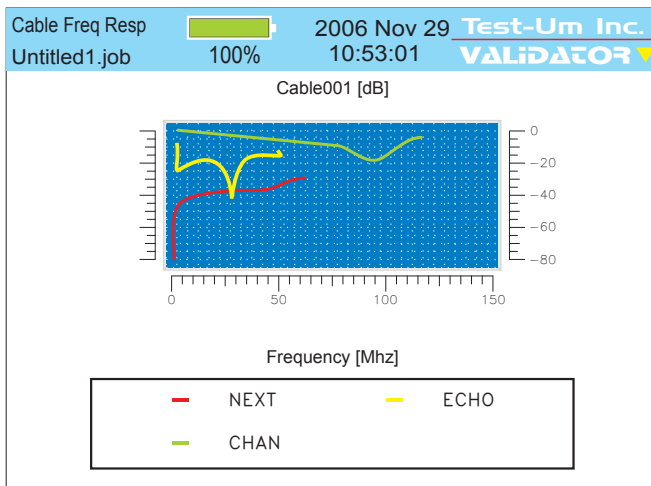

Auto Find Feature: It is necessary to connect the Validator remote unit to the other end of the cable to measure for both Speed and Performance. If the remote is not plugged in a message will appear “Remote not found. Alternating between Tone and Test.” We call this “Auto-find” and it is a feature that let’s you start the test and then go to the other end where the remote should be plugged in. If the end of the cable being tested is not known Validator helps by generating tone on the line so that a tone probe can be used to locate the far end of the cable. Auto-Find will terminate when the remote is plugged in.

Short - The pair has a low resistance connection between wire pairs or the shield. The wire pairs involved and the distance to the short in feet or meters displays in red on the wiremap screen. Press the PG DOWN soft key (F2) to view the detailed test results. (See Figure 4.3 & Figure 4.4)

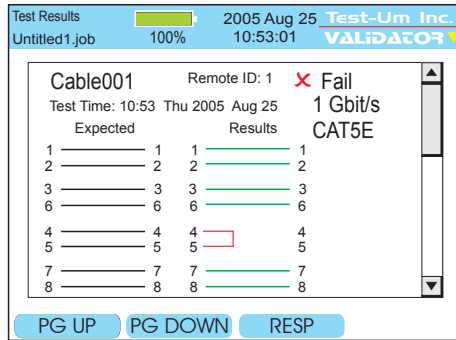

Figure 4.3 Test Results Short on Pair 4 and 5

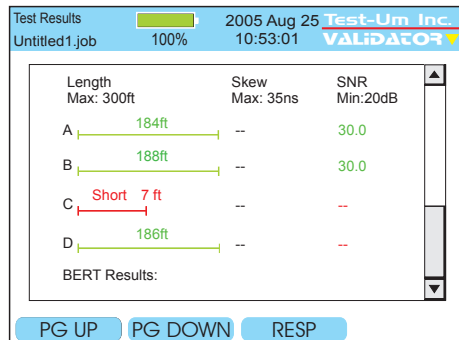

Figure 4.4 Page down to Display Distance to Short

Miswire - A wire or both wires of a pair are not connected to correct pins at the other end of the cable. For example, a reverse pair displays the wires connected to the correct pair of pins, but the two leads are reversed. (See Figure 4.5)

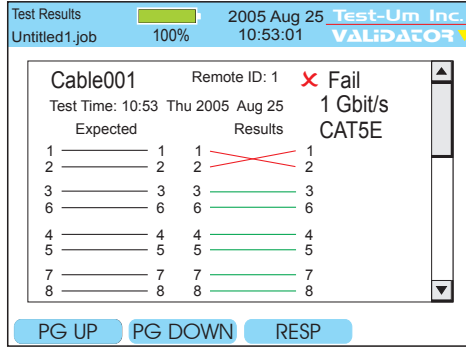

Figure 4.5 Test Results-Miswire

Split Pair - The cable has an error in the twisting of the wires together within the cable. Cables are generally made up of 8 wires twisted together in 4 pairs. A cable can be wired with correct continuity, but not with correct pairing. If the only error is a split pair error, the cable has correct continuity. If the Validator main unit is unable to link to its remote due to another error, such as a short, A Link Test Error Message displays “Unable to Measure SNR.” Press OK to view the wiremap results. (See Figure 4.6)

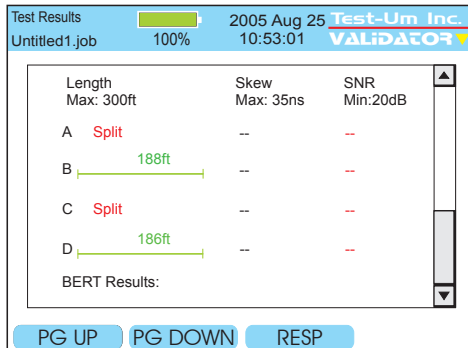

Figure 4.6 Test Results-Split

Auto Find Feature: It is necessary to connect the Validator-NT remote unit to the other end of the cable to measure for both Speed and Performance. If the remote is not plugged in a message will appear “Remote not found. Alternating between Tone and Test.” We call this “Auto Find” and it is a feature that let’s you start the test and then go to the other end where the remote should be plugged in. If the end of the cable being tested is not known, Validator-NT helps by generating tone on the line so that a tone probe (TT100) can be used to locate the far end of the cable. Auto Find will terminate when the remote is plugged in.

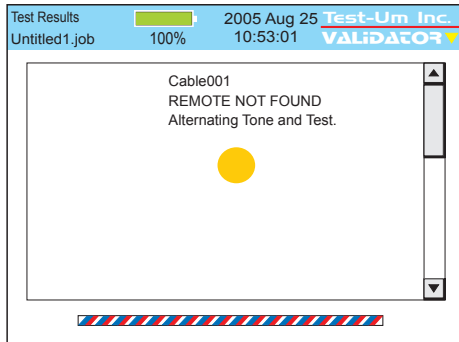

Figure 4.7 Cable Test without Remote

4.2. Site Info

The next button on the Auto Test sub-menu is **Site Info**. This button displays the Customer Contact Information associated with the job you have selected for testing. By highlighting and selecting a field you can update or change the information in each field, i.e.; Job ID, Contact name, etc. Press Accept to accept the changes that were made and exit that field. To save text press Menu, scroll to Save Job, and press Select.

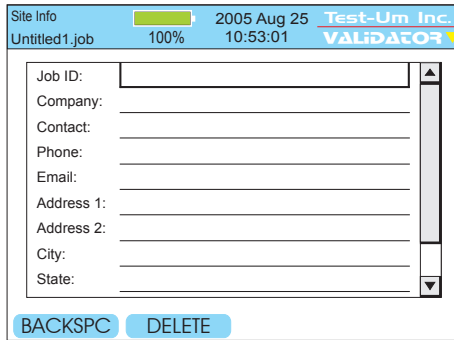

Figure 4.8 Customer Contact Information

4.3. Contractor Info

The next button is **Contractor Info**. Information on this screen can be added or changed in the same manner as on the Site Info screen.

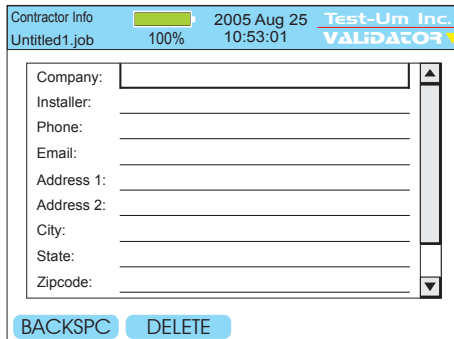

Figure 4.9 Contractor Information

4.4. Custom Cable Definitions

The Custom Cable Definitions screen shows all defined cable types loaded into the Validator from the current job and what category of test is performed on each type. The soft keys, F1 thru F3, allow for adding, editing, and deleting cable information. (Figure 4.10)

The recommended procedure is to create Custom Cable Definitions in Plan-Um® and upload them to Validator. However, by following the steps outlined below you can also create Custom Cable Definitions and Save them directly in your Validator.

Custom Cable Types will only be saved to the current job unless you create a Template File to store and retrieve this information.

1. Select **Auto Test** from the Start screen. Select **Custom Cable Definitions**.
2. Modify a default cable type or select New using the soft keys. Select Cable Type: Data, Phone, or 2-wire.
3. To create a New Custom Cable Definition, use the alphanumeric keypad to enter the information into each field. Press Accept when you are finished entering data into each field and to advance to the next field. You may also use the arrow keys on your keypad to navigate between fields. Backspace and Delete soft keys are provided to facilitate editing of information.
4. To edit an existing cable definition, use the alphanumeric keypad to modify the test parameters in each field. Press Accept or use the arrow keys to advance to the next field.
5. Length constant is used to calculate length measurements and may be adjusted for custom cable types depending upon their capacitance rating. Figure 5.1 displays typical cable length parameters.
6. Typical settings for custom cable types will include a Minimum SNR of 20 dB and Maximum SKEW of 35 nanoseconds on Ethernet cable rated for gigabit speed.
7. Wire Mapping, Pair Polarities, and Split Test selections are available using the drop down menus.

8. To save the custom test parameters you have entered, press the Save Type soft key (F3).
9. A message box appears that asks you to confirm the changes in the test parameters you have entered. If you are sure of the changes press Yes. To verify or edit or changes, repeat steps 4 through 7.

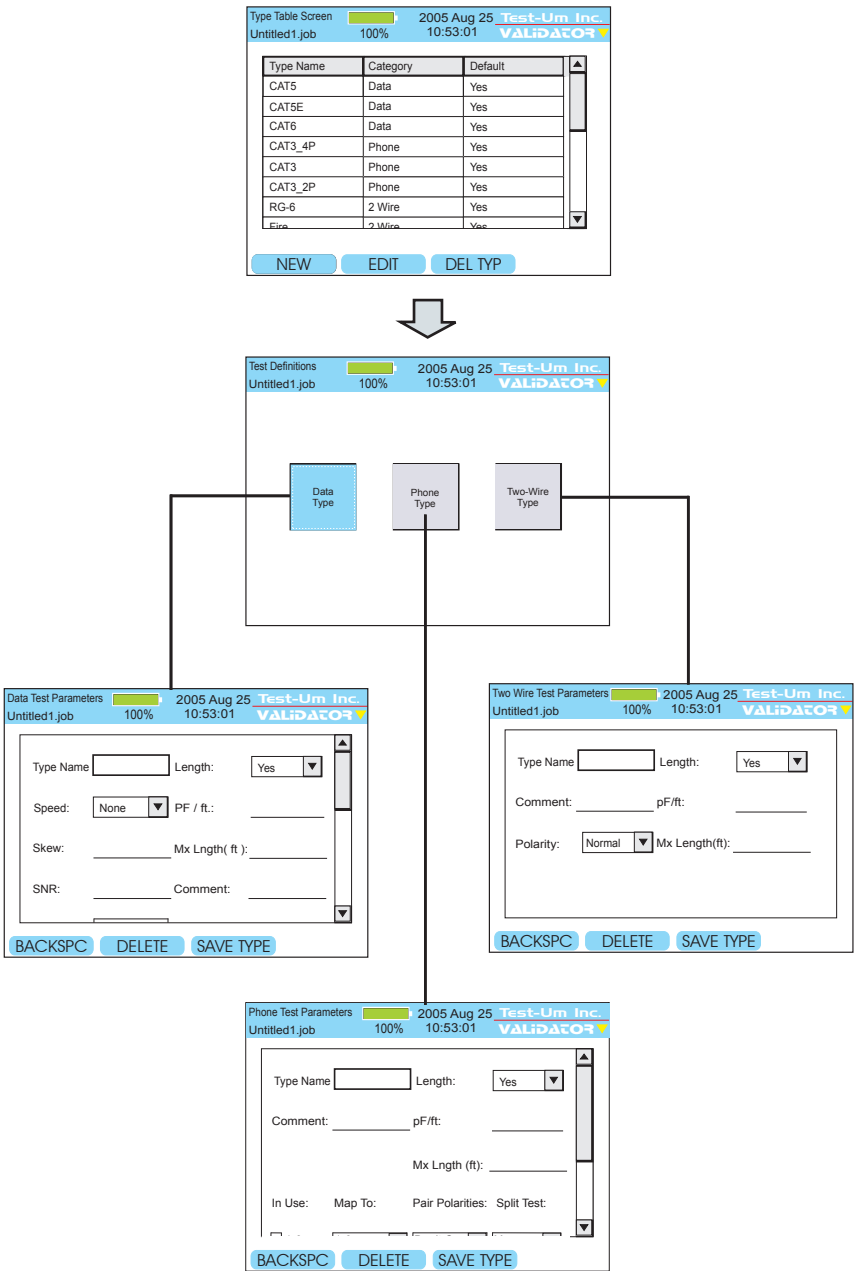

Figure 4.10 Custom Cable Flowchart

4.5. Job Utilities

The last button on the Auto Test menu is **Job Utilities**. This screen has buttons to allow creation of a new job file, open an existing job file on the CF card, export a template file, save the file that is currently open, or save an open file as a file with a new name (Figure 4.11)

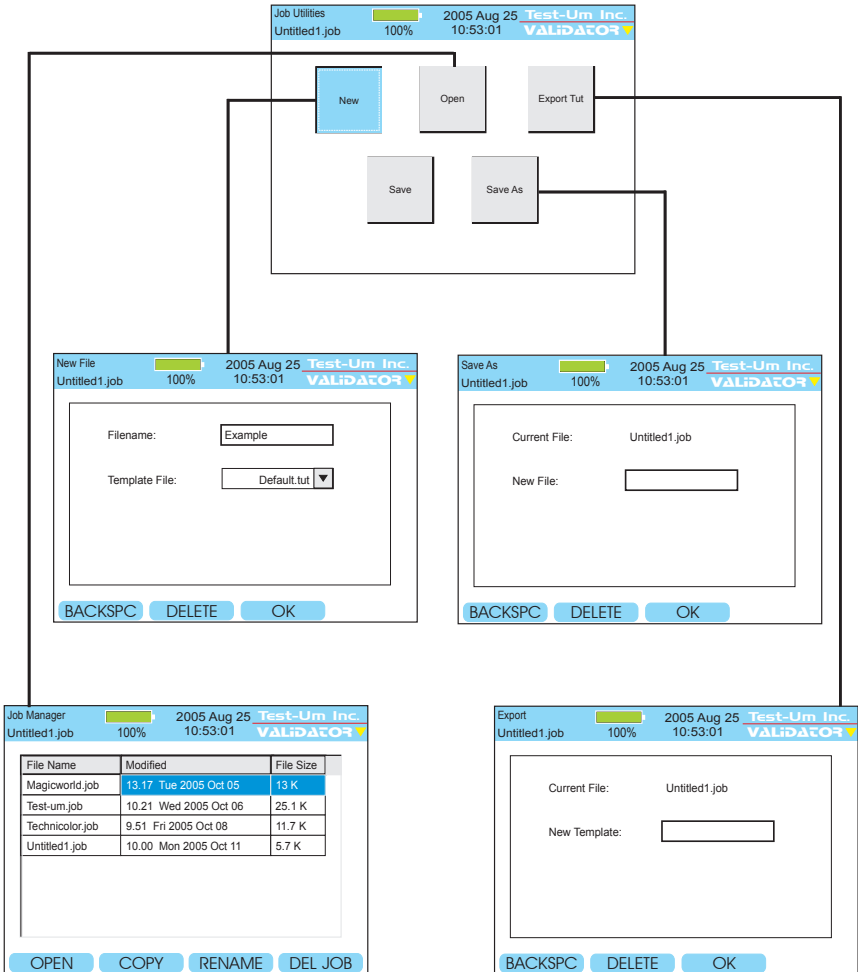

Figure 4.11 Job Utilities Flowchart

4.6. Step by Step Instructions for Performing Auto Tests

1. From the Start Menu, navigate to the Job Manager using the arrow keys which move from left to right on each row.
2. Select the Job you wish to test. Press Open.
3. The Auto Test screen is presented with the Cable Test Schedule button highlighted. Press Select to view the Test Schedule. Press the up and down arrows to highlight the cable to be tested.
4. Using the appropriate cable assembly and jacks, connect the Validator main unit to one end of the cable and the remote unit to the opposite end of the first cable identified in the Test Schedule.

Note: The Wiremapping Remotes (TP610) test wiremapping only and are NOT designed to work in the Auto Test mode. The Test Results will indicate Fail because the Validator was not able to perform a complete test sequence.

5. Press Test.
6. A message displays if the Main Unit is not communicating with the Remote Unit. If the Remote unit is not found, the main unit automatically sends tone on the cable. Using a Tone Tracer, such as JDSU's TT100, locate the cable you wish to test. Connect the Remote unit and testing will proceed.
7. Pass/Fail Test Results display, also indicating the speed the cable is certified to perform at, and whether the cable will support Voice over IP (VoIP).
8. The Validator automatically increments to the next cable to be tested.
9. Testing will proceed through the entire Cable Test Schedule regardless of test failures.
10. Press the Results (F3) soft key to display detailed test information for the cable that is currently highlighted.
11. Pass test parameters display in green and fail parameters display in red.

12. Test Results are automatically saved to the current job. To save text changes, select Save Job.

13. Test Results for the selected job can then be downloaded to laptop/ PC and an End of Job Report is generated for billing.

5. Running Manual Tests

Manual Tests performs individual tests on **Data**, **Phone**, or **2-wire cables** based on defined test standards. The tests that can be performed for each selected cable type are listed on the Manual Test screen for that type. (Figure 5.2)

5.1. Data Cables

Data Cables are defined as cables wired to T568A/B pin numbering and pairing. Validator will perform full Signal to Noise Ratio and Skew testing as part of the cable test. Speed testing is done with the Bit Error Rate Test (BERT). You can also send tone over the cable, check length, flash a hub or do a Speed Test with BERT.

Note: The TP610 Remote Wiremappers are designed to report wiremap, Skew and length results only. A Link Test Error message appears “Unable to Measure SNR.” To measure Signal to Noise Ratio you must use the Validator Smart Remote unit.

Length Constant is used for length measurement and is adjusted in .1pF increments by pressing the up and down arrow keys. The displayed cable length is recalculated as the length constant is changed. This allows an unknown length constant to be determined by attaching a known length of cable and running the test. The length constant can be varied up or down until the displayed length matches the measured length. The displayed length constant is then the correct value for that cable. This same adjustment feature is on both the Phone and 2-Wire test screens. (Figure 5.1)

Cable Type	pF/ft.	pF/m
Data Cable		
CAT3	19.0	62.5
CAT5/CAT5E/CAT6	15.0	49.0
Coaxial Cable		
RG58	27.5	90.0
RG6, RG11, RG59	16.25	53.0
Security Wire		
22AWG, Jacketed	24.0	78.5
22AWG, Unjacketed	14.0	46.0
20AWG, Unjacketed	16.0	52.5
18AWG, Unjacketed	17.0	55.5

Figure 5.1 Typical Cable Length Parameters

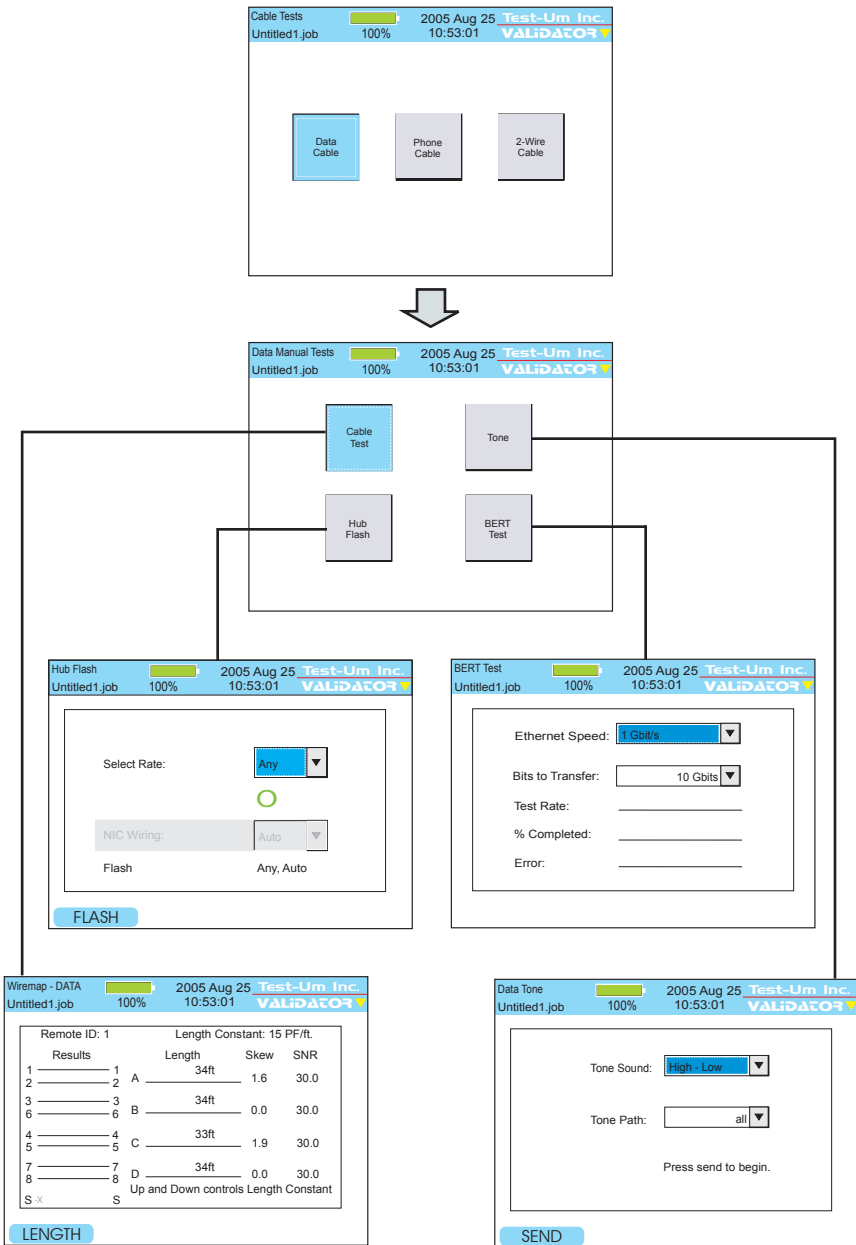

Figure 5.2 Data Manual Test Flowchart

5.2. Phone Cables

Phone Cables are defined as cables wired to the USOC 3 pair standard for pin numbering and pairing. The test shows opens, shorts and length of the run. The wiremap and length measurements are displayed. (Figure 5.3)

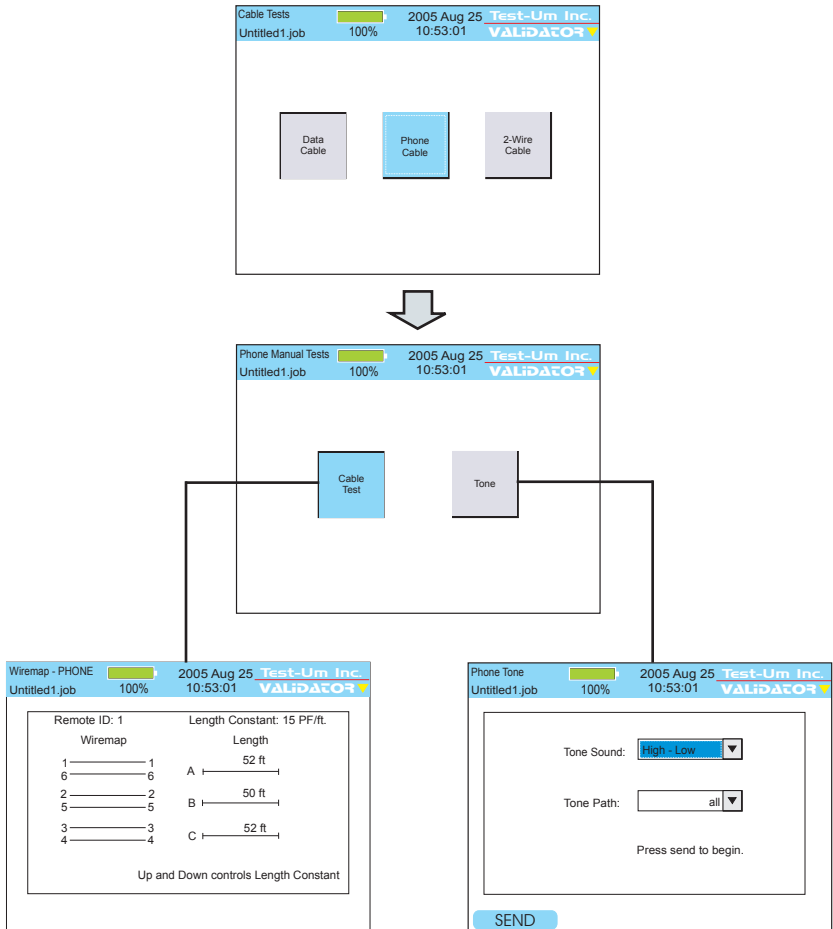

Figure 5.3 Phone Manual Test Flowchart

5.3. 2-Wire Cables

2-wire cables are tested for wire map and length. You can also send tone over the cable. (Figure 5.4)

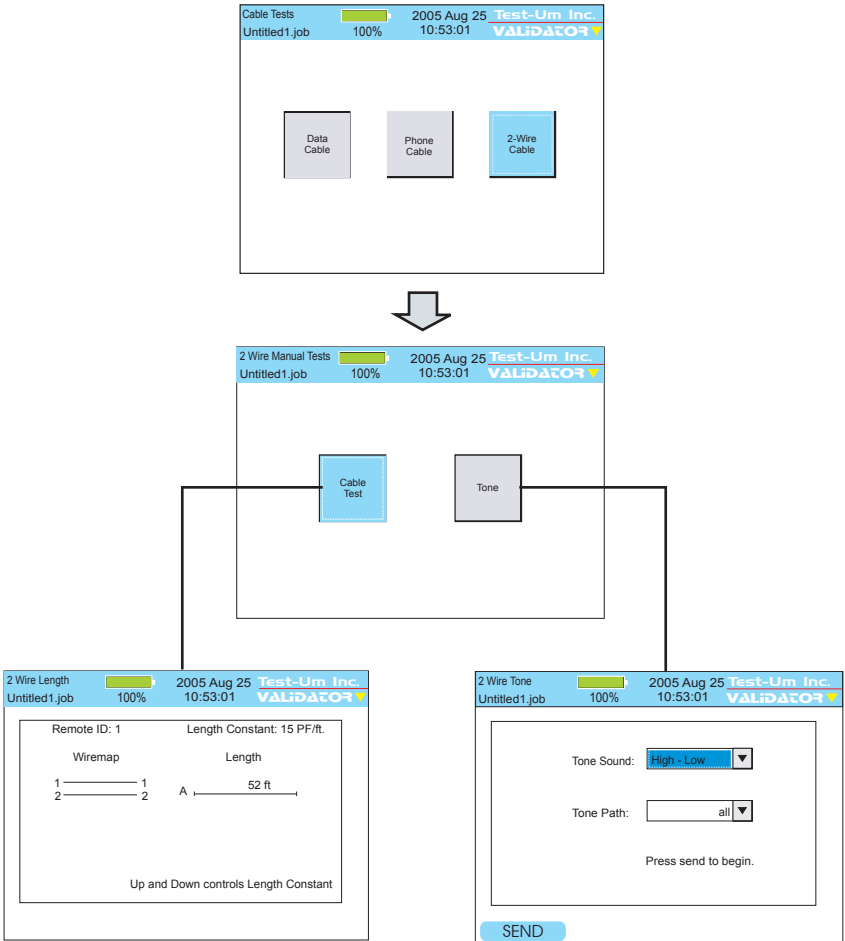

Figure 5.4 Two Wire Manual Test Flowchart

5.4. Step by Step Instructions for Performing Manual Tests

1. From the Start Menu, select Manual Tests. Choose **Data, Phone** or **2-wire cable type**.

Warning! Manual Test Results will NOT be saved.

2. Using the appropriate cable assembly and jacks, connect the Validator main unit to the cable identified in the Test Schedule with the Remote Unit connected to the opposite end.

Cable Test

1. Select Cable Test to initiate a test sequence. The wiremap, length, SNR, and Skew results will display. (Figure 5.5)
2. The up and down arrow keys adjust the length constant by .1 pF increments if the cable requires a different setting than that displayed at the top of the screen.
3. On the DATA test screen, the Length (F1) soft key can be used to run the length portion of the test sequence only, skipping the Skew and SNR tests.

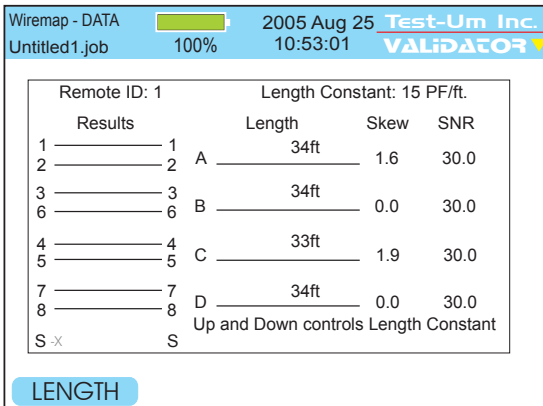

Figure 5.5 Manually Testing Cables

Placing Tone On a Cable Pair

1. Select **Manual Tests**. Choose **Data, Phone or 2-wire cable type**.
2. The Manual Test Menu for the cable type you selected displays.
3. Select **Tone**.
4. Select the desired **Tone Sound**. Press Accept. The cursor moves to the Tone Path dialog box. (Figure 5.6)
5. Select the **Tone Path** by choosing the cable pair or pairs you wish to apply Tone to. Press Accept.
6. Using the appropriate cable assembly, connect the cable to the Main unit jacks.
7. Press the **Send** (F1) soft key to start the tone.
8. Using a Tone Tracer, such as JDSU's TT100, trace the tone.

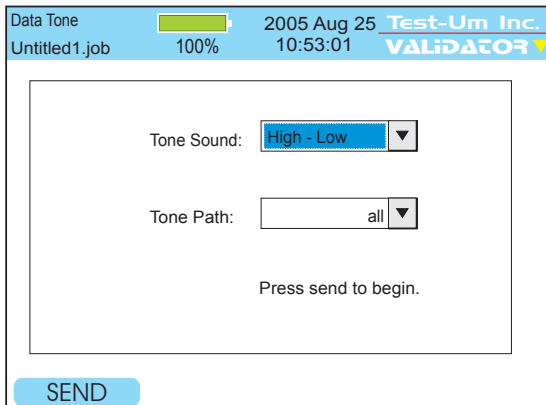

Figure 5.6 Tone Generator

Testing Cable Length

When you run Cable Test, length is reported in feet or meters. In addition, the Manual Cable Test for data includes a quick independent length test using the Length (F1) soft key. This test is useful to the installer to determine how much cable is left on the reel or the length of a cable run. Follow the procedure for Cable Tests described above. (Figure 5.7)

1. Select Manual Tests. Choose Data, Phone or 2-wire cable type.
2. The Manual Test Menu for the cable type you selected displays.
3. Using the right arrow key, select Cable Test.
4. The pF+ (▲) and pF- (▼) arrow keys adjust the length constant in pico farads per unit length if the cable requires a different setting than that displayed at the top of the screen.
5. Select the Length (F1) soft key.
6. The length of the cable pairs tested displays, as well as any associated errors.

Wiremap - DATA		2005 Aug 25	Test-Um Inc.
Untitled1.job		100%	10:53:01
		VALIDATOR	
Remote ID: 1		Length Constant: 15 PF/ft.	
Results	Length	Skew	SNR
1 _____ 1	34ft	--	--
2 _____ 2 A	34ft	--	--
3 _____ 3	34ft	--	--
6 _____ 6 B	34ft	--	--
4 _____ 4	33ft	--	--
5 _____ 5 C	34ft	--	--
7 _____ 7	34ft	--	--
8 _____ 8	34ft	--	--
S _____ S	Up and Down controls Length Constant		
LENGTH			

Figure 5.7 Testing Cable Length

Hub Flash Test

This test sends a link signal to test for active Ethernet equipment. This is the only test that runs with other Ethernet equipment.

1. From the Data Manual Test screen, select Hub Flash
2. From the drop down menu, select a specific data rate or Any if you wish to have the hub and Validator auto negotiate the speed. (Figure 5.8)
3. In 10Mb or 100Mb mode, the Validator can be set to emulate a NIC, a HUB or to Auto (auto MDI/MDIX) mode using the drop down menu. If plugging into a hub, the Validator must be set to NIC or Auto modes. The Auto mode can be used most of the time, but it may be necessary to select Hub or NIC mode when connecting to a network device that can “sleep” such as a laptop computer to wake it up.

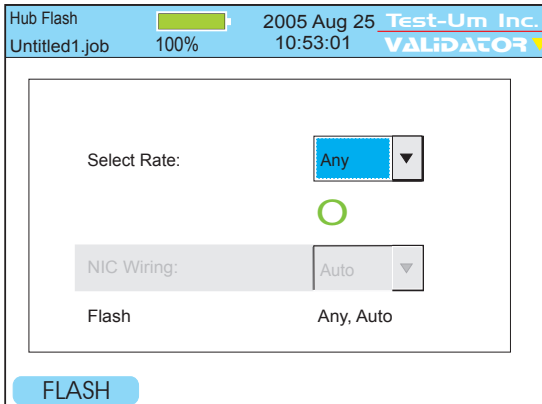

Figure 5.8 Hub Flash Test

Performing a Bit Error Rate Test

A Bit Error Rate Test (BERT) sends data packets from the main unit to the remote, measures speed and errors and correlates this to a PASS or FAIL result. This test can only be run from end to end on a single cable, it cannot be run through an Ethernet hub or switch.

1. From the Data Manual Tests screen, select the BERT Test button. (Figure 5.9)
2. Using the drop down dialog box, select an Ethernet speed of 1 gigabit or 100 Megabits. Press Accept
3. Select the number of bits to transfer from the drop down dialog box. Press Accept.
4. Press the Test button to begin the run. The % Complete will advance as the test proceeds and any errors will be reported as the % Completed is updated. A Pass or Fail will be displayed at the end of the test based on the industry standard of not more than one error in 10 Gigabits transferred.

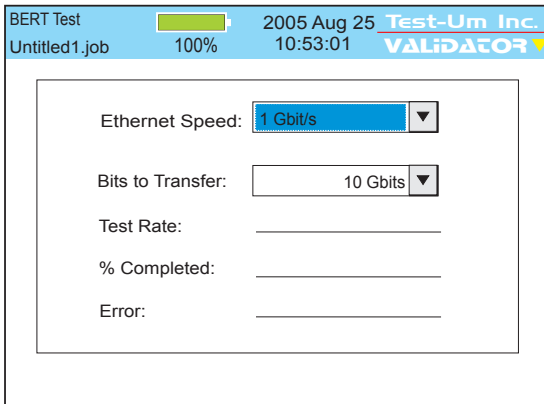

Figure 5.9 Bit Error Rate Test

6. Uploading/Downloading Jobs

6.1. Uploading the Cable Test Schedule to the Validator

Open the **My Documents** folder on your desktop. Right click the Plan-Um® job you want to transfer, and select **Copy**.

Power the Validator on. Open the **My Computer** folder on your desktop. Plug the USB cord into the USB port on your PC and into the Validator (Figure 6.1). As the connection is made, the drive the Validator is mapped to (usually Local Disk E:) appears on your desktop and the message “**USB – File I/O Mode**” appears in red on the Validator.

Right click the drive the Validator is connected to and select **Paste** to transfer the job file to the compact flash card on the Validator.

Do not remove the USB cable after this procedure; instead follow the instructions below to safely remove the USB cable

On your system tray (lower right side on your desk top), click the USB icon to safely remove hardware or Stop Mass Storage Device.

This completes the upload operation. Remove the USB cable from the Validator. When you remove the USB cable, the power automatically turns off on the Validator.

Power the unit on, select Job Manager, and open the job to begin testing. After you complete the testing and verification of the cables with the Validator, you will download the test results to Plan-Um®, populating the Length and Results columns on the Cable Test schedule.

6.2. Downloading Test Results from Validator to Plan-Um®

Open the **My Computer** folder on your desktop. Power the Validator on. Plug the USB cord into the USB port on your PC and into the Validator (Figure 6.1). As the connection is made, the drive the Validator is mapped to (usually Local Disk E:) appears on your desktop and the message “USB – File I/O Mode” appears in red on the Validator.

Right click the drive the Validator is connected to and select **Copy**. Open the **My Documents** folder on your desktop, right click, and select **Paste**. Select Yes to replace the previous file with one you just downloaded that contains the test results.

Do not remove the USB cable after this procedure; instead follow the instructions below to safely remove the USB cable. On your system tray (lower right side on your desk top), click the USB icon to safely remove hardware or Stop Mass Storage Device.

Open Plan-Um® and open the selected job file to view the populated Length and Results columns of the Cable Test Schedule.



Figure 6.1 Diagram of Validator Connected to PC

7. Archiving/Saving Test Results

To save, press Menu. Use the Up Arrow key to highlight Save Job and press Select to save your Test Results to the flash memory card. (Figure 7.1)

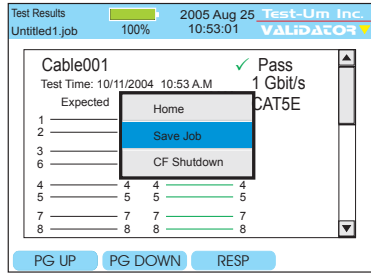

Another method for saving a job is to select the Job Utilities menu from the Current Job screen and press the Save or Save As option. (Figure 7.1)

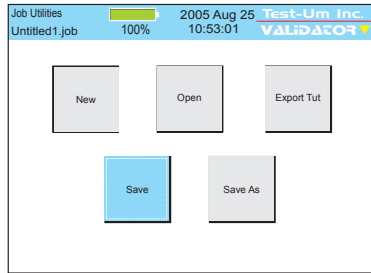

“Save as” will save your job as a new file name. Enter a name into the highlighted box next to New File using your alphanumeric keys. (Figure 7.1)

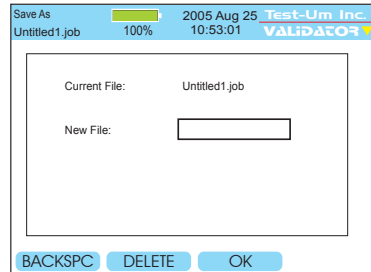

Figure 7.1 Options for Saving Jobs

Test results Auto Save after every cable test is performed. However, Job Information must be saved manually.

Download Test Results to a pc/laptop. Stored job information is used to generate an End of Job Report. Refer to the archived job for additional moves, adds, and changes.

8. Printing Test Results

The most efficient method to print job reports is to download test results to a pc/laptop. See Uploading/downloading Jobs.

Future upgrades may permit the user to print Test Results directly from the Validator to a serial port printer using a D-Sub 9 pin Male to Female cable assembly. (Figure 8.1)

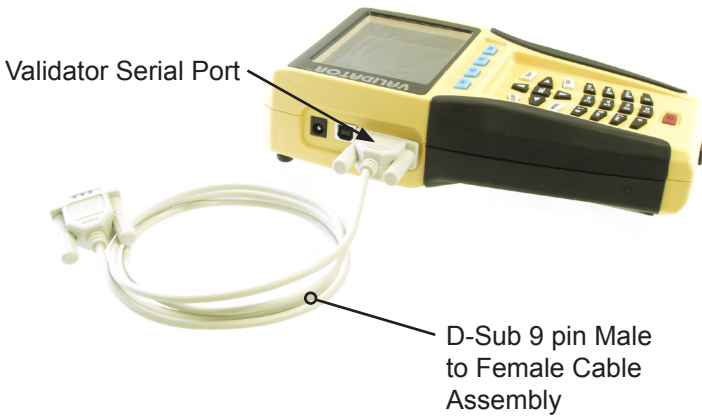

Figure 8.1 Serial Port Cable Connection to Validator

9. Application Notes for Typical Field Use

9.1. New Job, New Cable Installations

1. A Layout using the Plan-Um® software will be created conforming to the customers' facility or residence and a job id created.
2. Cables will be chosen and run between agreed upon ports and a Comm. Panel or Patch Panel.
3. Check Cable Test Schedule against the Layout to make sure all ports are connected correctly.
4. The Job File from the Plan-Um® software will be uploaded to the Validator Main unit. The Job File can then be accessed through the Job Manager on the Main Menu Screen of the Validator.
5. The Cable Test Schedule can be sorted so that all CAT 5E cables are listed first or all CAT 5 etc. This groups the types of cables for quicker testing at the Comm. or Patch Panel.
6. Once all tests are done, upload the finished Cable Test Schedule to the laptop or PC and print this as an End of Job report showing all the cable runs and PASS/FAIL results. This should be attached to a copy of the customer layout for comparison and final checking prior to billing.

9.2. New Job, Previously Installed Cables

1. Create a layout using the Plan-Um® software re-creating the customers' cabling system using port and cable icons in Plan-Um®.
2. Name the job and upload it to Validator for testing
3. Print out the finished Cable Test Schedule as an End of Job report for the customer to see what was tested and results.

9.3. Existing Job, Adds, Moves and Changes

1. Open the previously completed job on your PC or laptop and make changes as per customer requests.
2. Upload the file to the Validator. A screen prompt will appear notifying you that a file of the same name exists and do you want to overwrite it. Select Yes and proceed. The “old” file will be replaced with the updated customer file you have changed or added to.
3. You can then either re-test all the cables in the job or just the adds, changes and moves. Prior test results will be saved when the file is uploaded from the PC.
4. Printing out a finished Cable Test Schedule will show the new cables added. Highlight these cables to show the customer what has changed and was tested in this version.

10. Warranty

JDSU guarantees that its products will be free of all defects in material and workmanship. This warranty extends for the period of 12 months for test instruments and 3 months for cables from date of manufacture or purchase (proof of purchase required).

All product deemed defective under this warranty will be repaired or replaced at JDSU's discretion. No further warranties either implied or expressed will apply, nor will responsibility for operation of this device be assumed by JDSU.



WEEE Directive Compliance: JDSU has established processes in compliance with the Waste Electrical and Electronic Equipment (WEEE) Directive, 2002/96/EC. This product should not be disposed of as unsorted municipal waste and should be collected separately and disposed of according to your national regulations. In the European Union, all equipment purchased from JDSU after 2005-08-13 can be returned for disposal at the end of its useful life. JDSU will ensure that all waste equipment returned is reused, recycled, or disposed of in an environmentally friendly manner, and in compliance with all applicable national and international waste legislation. It is the responsibility of the equipment owner to return the equipment to JDSU for appropriate disposal. If the equipment was imported by a reseller whose name or logo is marked on the equipment, then the owner should return the equipment directly to the reseller. Instructions for returning waste equipment to JDSU can be found in the Environmental section of JDSU's web site at www.jdsu.com. If you have questions concerning disposal of your equipment, contact JDSU's WEEE Program Management team at WEEE.EMEA@jdsu.com.

10.1. Shipping

Before returning any product to JDSU, you must first request a Return Merchandise Authorization Number by contacting our Customer Service Dept. at (805) 383-1500.

- 1) No shipments will be accepted without this number, which must be clearly marked on the shipping label.
- 2) Ship the equipment with a copy of the sales receipt, if available.
- 3) Attach a description of the operational problem.
- 4) Include a contact name, phone number and E-mail address.
- 5) Pack securely to prevent damage during shipping.
- 6) Ship prepaid to: JDSU, 808 Calle Plano, Camarillo, CA 93012, USA.

Contact Information:

808 Calle Plano
Camarillo, CA 93012
USA

Regional Sales

North America
Tel: +1 805 383 1500
Fax: +1 805 383 1595

Latin America
Tel: +55 11 5503 3800
Fax: +55 11 5505 1598

Asia Pacific
Tel: +852 2892 0990
Fax: +852 2892 0770

EMEA
Tel: +49 7121 86 2222
Fax: +49 7121 86 1222

Customer Service

www.jdsu.com/customerservice

