

## Acterna ANT-20SE Specs

Provided by [www.AAATesters.com](http://www.AAATesters.com)

# ANT Advanced Network Tester Family

## ANT-20, ANT-20se, ANT-10G

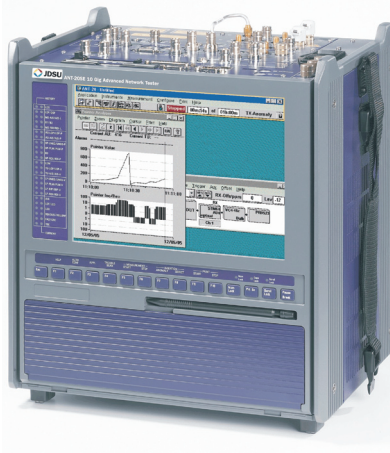

### Key Features

- Easy-to-use, portable, compact and comprehensive test kit for SDH/SONET bit rates up to STM-64/OC-192 including jitter and wander testing
- Platform offering SDH, SONET, PDH, DSn, and ATM capabilities
- Fully featured configurations, including BERT, errors, alarms, performance and pointer analysis and synchronization testing
- Pinpoint troubleshooting of in-service networks
- Complemented by a lot of easy-access, automated test features
- Large, color touch screen plus graphical results presentation



August 2006 Edition

### A design proven successful on a global base

Over the last few years, there has been a dramatic increase in global communications services.

The ANT has been designed working with systems manufacturers and network operators to define new standards of quality and technical excellence while guaranteeing maximum ease of use for testers and technicians.

Powerful, precise test capability or simple operation? PDH, SDH, SONET with all bit rates from 1.5 Mb/s to 10 Gb/s, or ATM? You don't have to choose. The ANT family delivers sophisticated, precision testing that is easy to use even in the most demanding environment for all the above bit rates and for ATM. In addition, comprehensive jitter/wander measurements in complete compliance with the ITU-T Rec. O.172 are supported for comparable, insightful and accurate measurement results.

The remote operation facilities give you the opportunity to reduce your costs e.g. operating the instrument from any Windows PC via modem or Ethernet LAN.

With its high degree of measurement flexibility, the ANT enables testers to investigate all major quality parameters using a variety of tests, ranging from simple bit error rate tests (BERTs) and performance and pointer analysis, to even complex synchronization testing.

The ANT family can be configured to meet user needs. It can resolve signal structures right up to STM-64/OC-192 level and analyze them down to 64 kb/s. Access to all standardized mapping structures is possible, including mixed structures, for example DS1 in STM-1 or E1 in STS-1.

## 2

## Configuration guide

### ANT-20/ANT-20se solutions

Packages	ANT version	Bit rates dual $\lambda$ up to	Jitter/Wander	10G single/dual	Jitter/Wander 10G	Ordering number
ANT-20 up to 155M el. P#13	SDH	el. only	option	–	–	BN 3035/13
ANT-20 up to 155M el. P#14	SONET	el. only	option	–	–	BN 3035/14
ANT-20 up to 155M P#1	SDH	155 M	option	–	–	BN 3035/08
ANT-20 up to 155M P#15	SONET	155M	option	–	–	BN 3035/15
ANT-20 up to 622M P#2	SDH	622 M	option	–	–	BN 3035/09
ANT-20se up to 622M P#5	SDH	622 M	option	–	–	BN 3060/55
ANT-20se up to 622M P#6	SONET	622 M	option	–	–	BN 3060/56
ANT-20se up to 2.5G P#7	SDH	2.5 G	option	–	–	BN 3060/57
ANT-20se up to 2.5G P#8	SONET	2.5 G	option	–	–	BN 3060/58

### Add jitter/wander for ANT-20 and ANT-20se solutions

Packages	Bit rates up to	Ordering number
Add jitter/wander up to 155M	155 M	BN 3035/91.29
Add jitter/wander up to 622M	622 M	BN 3035/91.31
Add jitter/wander up to 2.5G	2.5 G	BN 3060/91.32

### ANT-10G solutions

Packages	ANT version	Bit rates dual $\lambda$ up to	Jitter/Wander up to	10G single/dual	Jitter/Wander 10G	Ordering number
ANT-10G 1550 P#1	SDH	2.5 G	–	1550 nm	–	BN 3060/71
ANT-10G 1550 P#2	SDH	–	–	1550 nm	x	BN 3060/72
ANT-10G 1550 P#3	SDH	622 M	622 M	1550 nm	x	BN 3060/73
ANT-10G 1550 P#4	SDH	2.5 G	–	1550 nm	x	BN 3060/74*
ANT-10G Dual P#11	SDH	2.5 G	–	dual $\lambda$	–	BN 3060/81
ANT-10G Dual P#12	SDH	–	–	dual $\lambda$	x	BN 3060/82
ANT-10G Dual P#13	SDH	622 M	622 M	dual $\lambda$	x	BN 3060/83
ANT-10G Dual P#14	SDH	2.5 G	–	dual $\lambda$	x	BN 3060/84*
Add 10G electrical interfaces	for ANT-10G 1550 nm packages					BN 3060/91.48
Add 10G electrical interfaces	for ANT-10G dual $\lambda$ packages					BN 3060/91.54

\*Wander only Rx

### Options/accessories for all ANTs

Includes options	Bit rates up to	Ordering number
Add ATM up to 155M	155 M	BN 3035/90.63
Add ATM up to 622M	622 M	BN 3060/90.63
CATS professional		BN 3035/95.95
Remote control interface GPIB		BN 3035/92.10
Remote operation (PcAnywhere)		BN 3035/95.30
Optical power splitter ANTs		BN 3035/90.49
Calibration report ANTs		BN 3060/94.01
Hard case ANT-20		BN 0960/00.08
Soft case ANT-20		BN 3035/92.02
Hard case ANT-20se/10G		BN 3035/92.03

## 3

## Detailed specifications

### Mainframe

Specifications for either SDH or SONET valid for ANT-20/ANT-20se/ANT-10G SDH packages (all except BN 3060/58) or ANT-20se SONET package (only BN 3060/58) respectively

#### Generator PDH/SDH (SDH version) or DS<sub>n</sub>/SONET (SONET version)

##### Digital outputs (SDH version)

Interfaces to ITU-T Recommendation G.703 75 Ω unbalanced output, adapter jack selectable from Versacon 9 adapter system. Bit rates and line codes:

2048, 8448 and 34368 kb/s	HDB3, CMI
139264 and 155520 kb/s	CMI

120Ω balanced output, Lemosajack. Bit rate and line codes:

2048 kb/s	HDB3, CMI
Bit rate offset	± 500 ppm
Step size	0.001 ppm

##### Digital outputs (SONET version)

Interfaces to Telcordia GR-253, TR-TSY-000499, ANSI T1.102 75 Ω coaxial output, adapter jack selectable from Versacon 9 adapter system.

##### Bit rates and line codes

DS1	1544 kb/s; B8ZS, AMI, CMI
DS2	6312 kb/s; B8ZS, CMI
DS3	44,736 kb/s; B3ZS, CMI
STS-1	51,840 kb/s; B3ZS, CMI
STS-3	155,520 kb/s; CMI

100Ω balanced output, Bantam jack, bit rate and line codes

DS1	1544 kb/s; B8ZS, AMI, CMI
-----	---------------------------

##### Output pulses

DS1	DSX-1 compatible
DS2	rectangular
DS3, STS-1	HIGH, LOW, DSX-3
Bit rate offset	± 500 ppm
Step size	0.001 ppm

##### Clock

- Internal clock generation at all of the bit rates listed above.

Clock stability ± 2 ppm

- Synchronization to external signals via 75 Ω unbalanced input (SDH version) or 100 Ω unbalanced input (SONET version), BNC jack:

Reference clock 2048 kHz and 1544 kHz  
2048 kb/s (HDB3), 1544 kb/s (B8ZS) or receive signal.

- Clock outputs

Clock output at frequency of generator signal, approx. 400 mV (when terminated into 75 Ω), BNC jack.

2048 kHz reference clock output via trigger output.

#### STM-1 output signal (electrical) (SDH)

Generation of a STM-1 signal conforming to ITU-T Recommendation G.707

#### STS-1 and STS-3 output signal (electrical) (SONET)

Generation of a STS-3/STS-1 signal conforming to Telcordia GR-253, ANSI T1.105. The STS-3 signal consist of one internal STS-1 tributary signal with the remaining two tributaries filled with UNEQ. The STS-1 signal consists of one selectable mapping.

#### STM-1/STS-1 mappings (SDH/SONET)

C4 mapping (140 Mb/s in STM-1 and STS-3c)
STS-3 mapping BERT in STS-3c (and 140 Mb/s in STM-1)
STS-1 SPE mapping DS3 in STS-1
C3 mapping (45 Mb/s in STM-1, AU-3/AU-4)
C3 mapping (34 Mb/s in STM-1, AU-3/AU-4)
C2 mapping (6 Mb/s unframed/Bulk in STM-1)
VT6 SPE mapping (6 Mb/s in unframed/Bulk in STS-1)
C12 mapping (2 Mb/s in STM-1, AU-3/AU-4)
VT2 SPE mapping E1 in STS-1
C11 mapping (1.5 Mb/s in STM-1, AU-3/AU-4, TU11/TU12)
VT1.5 SPE mapping DS1 in STS-1

#### Content of the selected container

Framed or unframed PDH/DS<sub>n</sub> test pattern

PDH multiplex signal

External PDH/DS<sub>n</sub> signal

Test pattern without stuffing bits (bulk signal to O.181)

Content of non-selected containers framed PRBS 2<sup>11-1</sup>

Or using predefined standard sequences

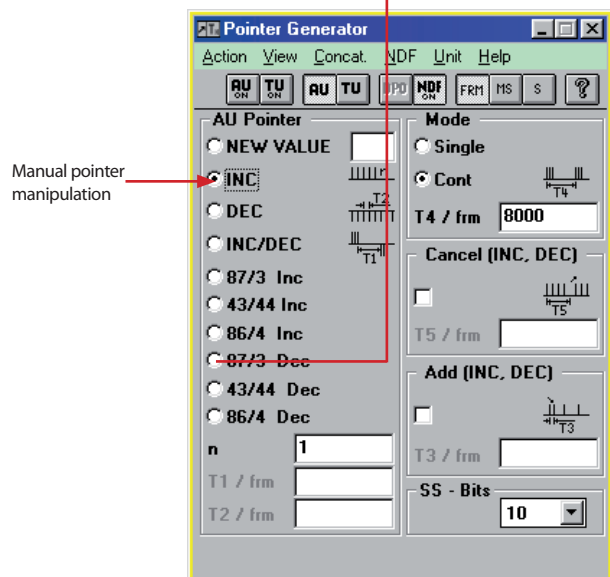

Insertion of pointer actions

## 4

**Generation of pointer actions**

Generation of pointer actions at the AU and TU levels simultaneously (SDH) and at the STS-1 and VT levels simultaneously (SONET).

- Pointer sequences to G.783 (SDH) and to T1.105.03 (SONET) with programmable spacing
- Pointer increment/decrement (continuously repeated)
- Single pointer
- Pointer value setting with or without NDF
- Trigger types: Single or continuous repeat

**Content of SOH and POH bytes (SDH) or TOH and POH bytes (SONET)**

The content of all bytes with the exception of B1, B2, B3 and H1 to H4 is programmable with any byte or a user defined byte-sequence p in m in n (p frames in m frames and the entire sequence repeated n times) can be inserted.

**Bytes E1, E2, F1, F2, and byte groups D1 to D3 and D4 to D12**

Transmission of a PRBS test pattern with bit error insertion (see test patterns)

Insertion of an external data signal via V.11 interface (also for K1, K2 and K3)

**Trace identifier**

J0, J1, J2	programmable 16 byte ASCII sequence with CRC
J1, J2, additionally	programmable 64 byte ASCII sequence
H4 byte	4 or 48 byte sequence

**Error insertion**

Error types (SDH)	B1, B2, B3, BIP2 parity errors, frame alignment signal errors, MS-REI, HP-REI, LP-REI, bit errors in test pattern, code errors (single errors)
Error types (SONET)	B1, B2, B3, BIP-V parity errors, frame errors, REI-L, REI-P, REI-V, bit errors in test pattern, BPV (single errors)

**Triggering**

Single error or error ratio	$2 \times 10^{-3}$ to $1 \times 10^{-10}$
for B1, B3, HP-REI, LP-REI (SDH)	$2 \times 10^{-4}$ to $1 \times 10^{-10}$
for B1, B3, REI-P, REI-V (SONET)	$2 \times 10^{-4}$ to $1 \times 10^{-10}$
for bit errors	$1 \times 10^{-2}$ to $1 \times 10^{-9}$
Step size for mantissa and exponent	1
Burst error: m anomalies in n periods	
For FAS, B1, B2, B3, MS-REI, HP-REI (SDH) or FAS, B1, B2, B3, REI-L, REI-P (SONET)	m= 1 to $4.8 \times 10^6$ and n=2 to 8001 frames or 0.2 s to 600 s

**Alarm generation****Dynamic:**

Alarm types (SDH)	LOF, MS-AIS, MS-RDI, AU-LOP, AU-AIS, HP-UNEQ, HP-RDI, HP-RDIEP, HP-RDIES, HP-RDIEC, TU-LOP, TU-AIS, LP-UNEQ, LP-RDI, LP-RDIEP, LP-RDIES, LP-RDIEC, LP-RFI
Alarm types (SONET)	LOS, AIS-L, RDI-L, LOP-P, AIS-P, UNEQ-P, RDI-P, RDIEPP, RDIEPS, RDIEPC, PDI-P, LOP-V, AIS-V, LOM, UNEQ-V, RDI-V, RDIEVP, RDIEVS, RDIEVC, RFI-V, PDI-V
m alarms in n frames	m = 1 to n-1, n <sub>max</sub> = 8000
or t1 alarm active, t2 alarm passive	t1 = 0 to 60 s, t2 = 0 to 600 s

**Static (on/off):**

Alarm types (SDH)	LOS, LOF, MS-AIS, RS-TIM, MS-RDI, AU-LOP, AU-AIS, HP-UNEQ, HP-PLM, HP-TIM, HP-RDI, HP-RDIEP, HP-RDIES, HP-RDIEC, TU-LOP, TU-AIS, LP-UNEQ, LP-PLM, LP-TIM, LP-RDI, LP-RDIEP, LP-RDIES, LP-RDIEC, LP-RFI
Alarm types (SONET)	LOS, LOF, AIS-L, TIM-L, RDI-L, LOP-P, AIS-P, UNEQ-P, PLM-P, TIM-P, RDI-P, RDIEPP, RDIEPS, RDIEPC, PDI-P, LOP-V, AIS-V, LOM, UNEQ-V, PLM-V, TIM-V, RDI-V, RDIEVP, RDIEVS, RDIEVC, RFI-V

**PDH output signals (SDH)****Signal structures for all bit rates****Unframed test pattern**

Framed test pattern (to ITU-T O.150); CRC-4 selectable for 2 Mb/s

**Error insertion**

Error types	bit errors, FAS errors, code errors (single errors)
Trigger types: Single error or error rate	$1 \times 10^{-2}$ to $1 \times 10^{-9}$
Step size for mantissa and exponent	1

**Alarm generation, dynamic**

Alarm types	LOF, RDI
m alarms in n frames	m = 1 to n-1, n <sub>max</sub> = 1000

**Alarm generation, static (on/off)**

Alarm types	LOS, LOF, AIS, RDI
-------------	--------------------

**Test patterns**

Pseudo-random bit sequences	
PRBS: $2^{11}-1$ , $2^{15}-1$ , $2^{20}-1$ , $2^{23}-1$ , $2^{11}-1$ inv., $2^{15}-1$ inv., $2^{20}-1$ inv., $2^{23}-1$ inv.	
Programmable word length	16 bits

## DS1, DS2 and DS3 output signals (SONET)

### Signal structures

#### Unframed test pattern

Framed test pattern (only DS1, DS3)	
DS1 frame structure	SF, ESF
DS3 frame structure	M13, C parity

### Error insertion

Bit errors in test pattern	error rate, single error
BPV	single error
DS1 F bit (LOF)	single error, 2 in 4, 2 in 5, 2 in 6
CRC-6 (ESF)	single error, error rate
DS3 F bit (LOF)	single error, 2 in 2, 2 in 3, 3 in 3, 3 in 15, 3 in 16, 3 in 17
P parity, CP parity, FEBE	single error, error rate
Error rate	$1 \times 10^{-2}$ to $1 \times 10^{-9}$

### Alarm insertion

DS1	LOF, AIS, YELLOW
DS3	LOF, AIS; YELLOW, IDLE, FEAC

### FEAC far end alarm and control signals

To test that FEAC alarm and status information is correctly transmitted, the relevant signal codes can be selected and inserted into the DS3 C-bit frame format.

### Test patterns

Pseudo-random bit sequences	
PRBS: $2^{11}-1$ , $2^{15}-1$ , $2^{20}-1$ , QRSS 20, $2^{11}-1$ inv., $2^{15}-1$ inv., $2^{20}-1$ inv., $2^{23}-1$ inv., $2^{31}-1$ inv.	
Programmable word length	16 bits

## Receiver PDH/SDH (SDH)

### Digital inputs (SDH)

Interfaces to ITU-T Recommendation G.703

75  $\Omega$  unbalanced input; adapter jack selectable from Versacon 9 adapter system, bit rates and line codes:

2048, 8448 and 34368 kb/s	HDB3, CMI
139264 and 155520 kb/s	CMI

120  $\Omega$  balanced input, Lemosá jack, bit rate and line codes:

2048 kb/s	HDB3, CMI
Clock recovery pulling range	$\pm 500$ ppm

#### Selectable input gain

CMI coded	15 to 23 dB
B3ZS, B8ZS, HDB3, AMI coded	15 to 26 dB
Selectable adaptive equalizers for 1544, 2048, 34368, 44736, 51840, 139264 and 155520 kb/s	

Monitor input for STM-1 and STM-4 NRZ signals.

### STM-1 and PDH receive signal (SDH)

For signal structures see generator

## Receiver PDH/SDH (SONET)

### Digital inputs (SONET)

Interfaces to Telcordia GR-253, TR-TSY 000499, ANSI T1.102.

75  $\Omega$  coaxial input; adapter jack selectable from Versacon 9 adapter system, bit rates and line codes:

DS1	1544 kb/s; B8ZS, AMI, CMI
DS2	6312 kb/s; B8ZS, CMI
DS3	44,736 kb/s; B3ZS, CMI
STS-1	51,840 kb/s; B3ZS, CMI
STS-3	155,520 kb/s; CMI

100  $\Omega$  balanced input, Bantam jack, bit rate and line codes:

DS	1544 kb/s; B8ZS, AMI, CMI
----	---------------------------

#### Input levels

DS1	DSX-1 compatible
DS3, STS-1	HIGH, LOW, DSX-3
Clock recovery pulling range	$\pm 500$ ppm
Selectable input gain, CMI coded	15 to 23 dB
B3ZS, B8ZS, HDB3, AMI coded	15 to 26 dB
Selectable adaptive equalizers for DS3, STS-1	450 ft
DS1	1310 ft

Monitor input for STS-3 and STS-12 NRZ signals

### STS-1, STS-3, DS1 and DS3 receive signals (SONET)

For single structures see generator.

### Acoustic indication of anomalies and defects

Beeper upon any anomaly and defect.

### Trigger output (SDH/SONET)

75  $\Omega$  BNC connector, HCMOS signal level.

Pulse output for received bit errors, transmit frame trigger, transmit pattern trigger or 2048 kHz reference clock.

## Measurement types

### Error measurements

All errors are evaluated and displayed in parallel

Error types (SDH)	B1, B2, B3 parity errors MS-REI, HP-REI, bit errors in test pattern, code errors
Error types (SONET)	B1, B2, B3, BIP-V parity errors, frame errors REI-L, REI-P, REI-V, bit errors in test pattern, BPV

Additionally, for

DS1	CRC errors
DS3	P-parity errors, CP-parity errors, FEBE
Error count, error rate, intermediate errors	

**Alarm detection**

All alarms are evaluated and displayed in parallel

Alarm types (SDH)	LOS, OOF, LOF, MS-AIS, MS-RDI, RS-TIM, LTI, AU-AIS, AU-LOP, AU-NDF, HP-RDI, HP-UNEQ, HP-TIM, HP-PLM, AIS, RDI, LSS, TU-NDF, TU-LOP, TU-AIS, LP-UNEQ, LP-RDI, LP-RDIEP, LP-RDIES, LP-RDIEC, LP-RFI
Alarm types (SONET)	LOS, OOF, LOF
Additionally, for STS	AIS-L, RDI-L, AIS-P, LOP-P, NDF-P, RDI-P, LTI, AU-AIS, AU-LOP, AU-NDF, UNEQ-P, TIM-P, PLM-P, LOP-V, AIS-V, LOM, UNEQ-V, PLM-V, TIM-V, RDI-V, NDF-V, RDIEVP, RDIEVS, RDIEVC, RFI-V
Additionally, for DS1, DS3 LSS, AIS; RAI (YELLOW), IDLE (DS3), FEAC (DS3)	

**Performance analysis (SDH)****G.821**

Evaluation of PDH and SDH systems to ITU-T Recommendation

ES, EFS, SES, DM and UAS are evaluated. Pass/fail assessment based on line length allocation of 0.1 to 100%. The SES and DM thresholds are user-settable. Evaluation for higher bit rates (up to 140 Mb/s) is obtained using a multiplex factor as per G.821, Annex D.

Measurements can be made using the following events:

PDH systems	bit errors, FAS2, FAS8, FAS34, FAS140, CRC and E-bit errors
SDH systems	payload bit errors (PDH and bulk), overhead bytes E1, E2, F2, D1 to D3, D4 to D12

**G.826**

*Evaluation to ITU-T Recommendation*

EB, BBE, ES, EFS, SES and UAS are evaluated.

Pass/fail assessment based on line length allocation of 0.1 to 100%.

The SES and UAS thresholds are user-settable.

*In-service measurement (ISM)*

Simultaneous in-service measurement of near end and far end of a selected path:

Near end: B1, B2, HP-B3, LP-B3, BIP2, FAS at 140/34/8 or 2 Mb/s, CRC-4

Far end: HP-REI, LP-REI, E-bit at 2 Mb/s

*Out-of-Service Measurement (OOS)*

Out of service measurement using bit errors in the test pattern (for PDH and SDH).

**G.828 and G.829**

*Evaluation of SDH systems to ITU-T Recommendation*

The G.828 defines error performance parameters and objectives for international synchronous paths.

ES, EFS, SES, BBE, SEP and UAS are evaluated.

Pass/fail assessment based on line length allocation of 0.1 to 100%.

The SES and UAS thresholds are user-settable. The SEP can be switched off for assessment.

The recommendation G.829 defines error performance events and block structures for SDH multiplex and regenerator sections.

**M.2100**

*Evaluation of PDH and SDH systems to ITU-T Recommendation*

This recommendation describes requirements during line-up and maintenance (in-service).

ES, EFS, SES and UAS are evaluated.

Pass/fail assessment based on line length allocation of 0.1 to 100%.

The UAS and BISO (bringing into service objectives) thresholds are user-settable.

ISM simultaneously for near end and far end of a selected path:

PDH systems,

near end	bit errors, FAS2, FAS8, FAS34, FAS140, CRC-4
far end	E-bit at 2 Mb/s
SDH systems	payload bit errors (PDH and bulk), overhead bytes E1, E2, F2, D1 to D3, D4 to D12

This operating mode allows application of the “Bringing into Service” procedures as per ITU-T Rec. M.2110 and the determination of “Performance Information” as per ITU-T Rec. M.2120.

**M.2101**

*Evaluation of SDH systems to ITU-T Recommendation (revision 09/99)*

This recommendation describes requirements during line-up and maintenance (in-service)

ES, EFS, BBE, SEP, SES and UAS are evaluated according to the newest Revision of M.2101.

Pass/fail assessment based on line length allocation of 0.1 to 100%.

The UAS and BISO (bringing into service objectives) thresholds are user-settable.

ISM simultaneously for near end and far end of a selected path or multiplex section:

Evaluated anomalies	payload bit errors (TSE), B1, B2, B3 and BIP2, MS-REI, HP-REI, LP-REI
---------------------	---

This operating mode allows application of the “Bringing into Service” procedures as per ITU-T Rec. M.2110 and the determination of “Performance Information” as per ITU-T Rec. M.2120.

**Performance analysis (SONET)**

ES, SES, EFS, SEFS, UAS are evaluated

*In-service measurements (ISM) (for SONET)*

Simultaneous ISM of the near end and far end of a selected path

Near end	B1, B2, B3, BIP-V, CRC-6
Far end	REI-L, REI-P, REI-V
DS1, DS3 events	Fbit, parity, FEFE, C parity

*Out of service (OOS) measurements (for SONET)*

OOS evaluation using bit errors in test pattern



**Analysis of AU and TU pointer actions**

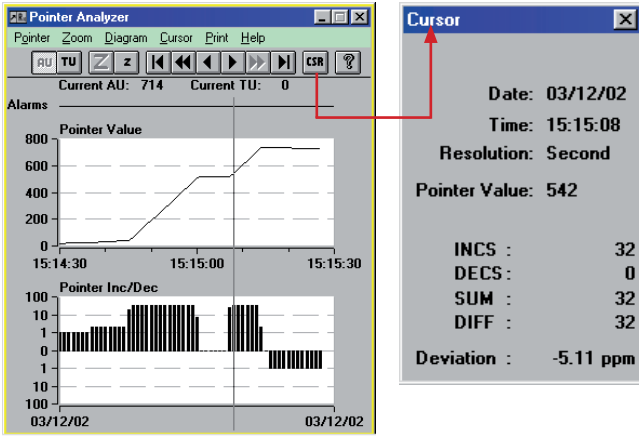

Graphic pointers. Display showing additional evaluation of cursor position

Display of

- Number of pointer operations:  
Increment, Decrement, Sum (Increment + Decrement), Difference (Increment – Decrement)
- Pointer value

**Clock frequency measurement**

The deviation of the input signal clock frequency from the nominal frequency is displayed in ppm.

**Delay measurement**

A delay measurement is used to line-up satellite hops, to test the maximum permitted latency in storage exchanges and cross-connect systems and to check the loop circuits of regenerators. The ANT measures the time taken for the test pattern to be transmitted from the generator back to the receiver via the path under test. The measurement is made on the test patterns in the selected channel, in the containers (bulk or PDH/DSn) for SDH/SONET or in the selected channel at the lowest hierarchy level of PDH/DSn multiplex systems. To avoid ambiguities in the measurement, two measurement times are provided.

Measurement range (for PDH/SDH)

Bit rates from 8 to 155 Mb/s	1 μs to 1 s
Bit rate 2 Mb/s	10 μs to 5 s
Bit rate 64 kb/s	100 μs to 16 s

Measurement range (for DSn/SONET)

Bit rates from 34 to 155 Mb/s	1 μs to 1 s
Bit rate 1.5 Mb/s	10 μs to 5 s

**SOH (for SDH), TOH (for SONET) and POH evaluation**

Display of complete SOH (for SDH), TOH (for SONET) and POH and clear text interpretations of K1 to K4, S1, C2, V5

For the bytes E1, E2, F1, F2 and byte groups D1 to D3 and D4 to D12:

- BERT using test pattern from the generator
- Output of the data signal via the V.11 interface (also for K1/K2, K3 and N1 and N2)

For the trace identifier

J0	display of 16 byte ASCII sequence
J1, J2	display of 16 or 64 byte ASCII sequence

**Measurement interval**

Variable	1 second to 99 days
Measurement start	manual or automatic timer (user setting)
Measurement stop	manual or automatic timer (user setting)

**Memory for errors, pointer operations and alarms**

Resolution of error events and pointers	1 s
Alarm resolution	100 ms

**64k/140M MUX/DEMUX chain**

Provides n x 64 kb/s to 140 Mb/s multiplex and demultiplex functions. The output signal is fed to the electrical interface and is available as payload in mappings.

Alarms and errors can be generated and analyzed.

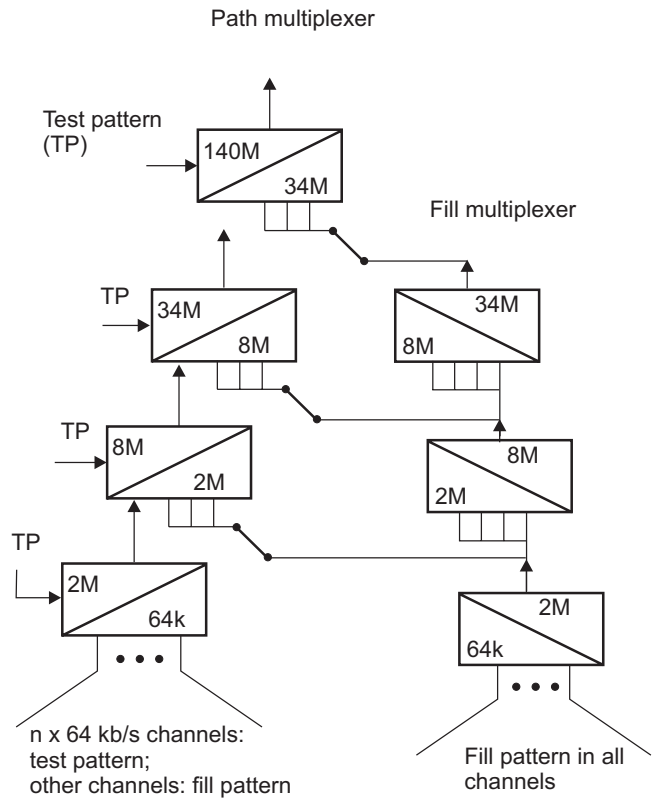

**M13 MUX/DEMUX chain**

M13 multiplexers are used in North America in hybrid networks and synchronous system cross-connects.

Provides n x DS0 to DS3 multiplex and demultiplex functions. The output signal is fed to the electrical interface and is available as payload in mappings.

Alarms and errors can be generated and analyzed.

**Drop & Insert (SDH)**

Following functions:

*1. Generator and receiver operate independently*

as mapper and demapper. The PDH signal from a selected channel is dropped from the receive signal and output to a connector. An external or internal PDH signal is inserted into the transmit signal.

*2. Through mode with jitter injection, error insertion and overwriting of SOH bytes:*

available for all bit rates up to 10 Gb/s

The received signal is looped through the ANT family and re-transmitted (generator and receiver coupled).

The looped-through synchronous signal can be manipulated if required:

- Overwriting bytes in the SOH (except B1, B2, H1 to H3)
- Overwriting of B3 byte at 10 Gb/s
- Anomaly insertion
- Defect generation by programming the SOH
- Jitter injection (jitter options required)

*3. Block and replace (B&R)*

For this function, the ANT family is looped into the working fiber or a ring. B&R allows replacement of a synchronous container (for example STM-1 including SOH, POH and payload.) in an STM-N signal. This can then be measured by the ANT family from the ring. By inserting specific errors, the error thresholds of the APS mechanism in the system can be tested.

Additional input and output for tributary signals 75Ω, coaxial BNC; line codes as for mainframe instrument.

Input and output for balanced tributary signals: Use balanced connectors on mainframe.

**Drop & Insert (SONET)**

Following functions:

*1. Generator and receiver operate independently*

as mapper and demapper. The DS1/DS3 signal from a selected channel is dropped from the receive signal and output to a connector. An external or internal DS1/DS3 signal is inserted into the transmit signal.

*2. Through mode with jitter injection, error insertion and overwriting of TOH bytes:*

The received signal is looped through the ANT family and re-transmitted (generator and receiver coupled). The looped-through synchronous signal can be manipulated if required for:

- Overwriting bytes in the TOH (except B1, B2, H1 to H3)
- Overwriting of B3 byte at 10 Gb/s
- Anomaly insertion
- Defect generation by programming the TOH
- Jitter injection (Jitter options required)

*3. Block and replace (B&R)*

For this function, the ANT family is looped into the working fiber or a ring. B&R allows replacement of a synchronous tributary (for example STS-1 including TOH, POH and payload.) in a OC-N signal. This can then be measured by the ANT family from the ring. By inserting specific

errors, the error thresholds of the APS mechanism in the system can be tested.

**Ring testing – APS time measurement**

In synchronous networks, a defined maximum switch-over time is necessary for the traffic in case of a fault. To verify compliance with this requirement, the ANT family measures the switch-over time with 1 ms resolution. The result can be printed.

Criteria for the time measurement (for SDH)	TU-AIS, MS-AIS, AU-AIS, bit error
Criteria for the time measurement (for SONET)	AIS-L, AIS-V, AIS-P, bit error
Max. measurable switch-over time	2 s
Resolution	1 ms
Allowable error rate for user signal	<2 x 10 <sup>-4</sup>

**Ring testing – Byte capture SOH and POH (for SDH)**

To analyze the SOH/POH functions, it is necessary to capture individual bytes vs. time, allowing detection of errors or short-term changes with frame level precision.

The capture function is started by a selectable trigger. Values for a selected byte are stored and can be accessed subsequently in a table of values.

Particularly in capturing the APS sequences, the bytes (K1/K2) are displayed as an abbreviation of the standard commands.

The function also allows recording of the N1 or N2 bytes for evaluation of “Tandem Connection” information.

H4 sequences can also be analyzed very easily. The results can be printed or exported.

Capture bytes for STM-0/1, el. and opt.	all SOH/POH bytes
STM-N el. and opt.	all SOH/POH bytes, channel 1 except A1, A2, B1
Storage depth for a byte	266
K1, K2	200
Trigger events	MS-AIS, AU-AIS, MS-RDI, AU-LOP, editable value in trigger byte
Capture resolution	frame precision

**Ring testing – Byte capture TOH and POH (for SONET)**

To analyze the TOH/POH functions, it is necessary to capture individual bytes vs. time, allowing detection of errors or short-term changes with frame level precision. The capture function is started by a selectable trigger. Values for a selected byte are stored and can be accessed subsequently in a table of values. Particularly in capturing the APS sequences, the bytes (K1/K2) are displayed as an abbreviation of the standard commands. The function also allows recording of the N1 or N2 bytes for evaluation of tandem connection (TCM) information.

H4 sequences can also be analyzed very easily. The results can be printed or exported.

Capture bytes for STS-1/3/3c, el. and opt.	all TOH/POH bytes
OC-N el. and opt.	all TOH/POH bytes, except A1, A2, B1
Storage depth for a byte	266
K1, K2	200
Trigger events	AIS-L, AIS-V, AIS-P, RDI-L, LOP-P, editable value in trigger byte
Capture resolution	frame precision



**Tandem connection monitoring (TCM) (SDH)**

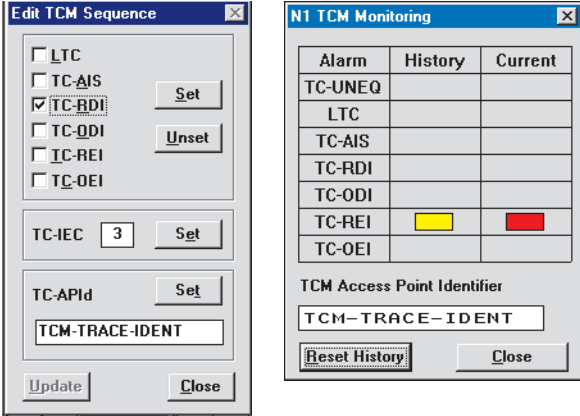

TCM monitor and editor

TCM is a method used to monitor the performance of a subsection of an SDH path via the N1/N2 bytes. This is particularly useful when the path is routed via different network providers. If errors occur on an end-to-end connection, you can use TCM to determine which sub-network the errors occurred in.

The ANT family helps to monitor the content of the N1/N2 bytes and provides users with easy interpretation of the detailed events.

Capture TCM frames	all N1/N2 bytes, TC-IEC, TC-AIS, TC-REI, TC-OEI
Trigger events	Start of TCM frame (TCM FAS word)
Storage depth	266 bytes (3.5 TCM frames)
On-line monitoring of alarms and trace identifier.	
Display of actual and history values	TC-UNEQ, LTC, TC-AIS, TC-RDI, TC-ODI, TC-REI, TC-OEI
On-line display of TCM access point identifier	
TCM error measurement	
Error types	TC-IEC, TC-DIFF, TC-REI, TC-OEI

**TCM byte sequencer and editor (for SDH)**

This serves to test a sequential TCM process (tandem connection monitoring) in the N1/N2 bytes. A sequence of 76 bytes simulating a TCM frame (equivalent frame) is generated. Individual values can be edited as binary or hexadecimal values to simulate various events for TCM evaluations.

Additionally major events may be simulated, line alarm, errors and trace identifier

Alarms	TC-ODI, TC-AIS, TC-RDI
Errors	TC-OEI, TC-IEC
Trace	TC-APID

**Result display and instrument operation**

*Numerical display*

Display of absolute and relative values for all error types	
Intermediate results	every 1 s to 99 min

*Graphical display (histogram)*

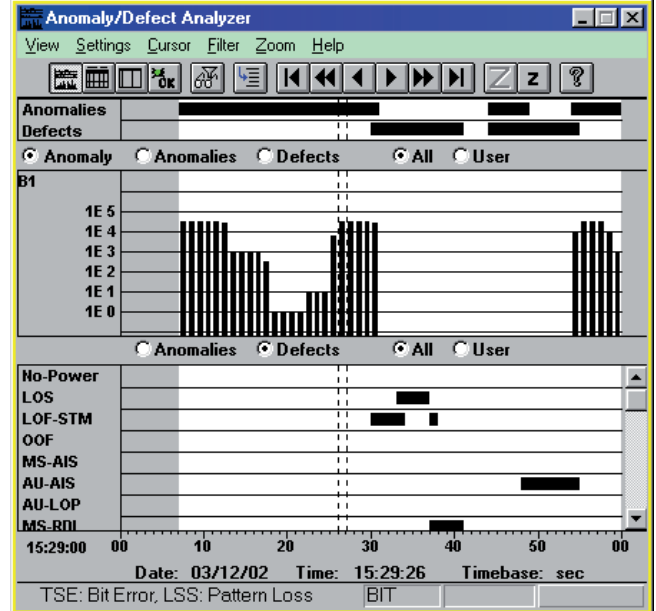

Histogram results and display

Display of errors, pointer operations/values and alarms as bar graphs vs. time

Units, time axis seconds, minutes, 15 minutes, hours, days

*Tabular display*

Display of all alarm and error events with time stamp

*Result printout*

ANT family supports a variety of dot-matrix, ink jet and laser printers. (Windows print manager)

*Printer interfaces*

Serial	V.24/RS232
Parallel	Centronics/EPP/IEEE P 1284

*Result export*

Results are stored in a database and can be processed using standard PC software.

*Instrument operation*

ANT family is operated using the standard Microsoft® Windows™ graphical user interface.

Operation is menu-controlled using the trackball or touch screen. A mouse can also be connected if desired.

*Application selection and storage*

ANT family includes an applications library to which customer-specific applications can be added. All applications are stored internally on the built-in hard disk drive and can be copied to any other ANT via floppy disk, USB, PCMCIA card and LAN.

Easy to use filter functions allow quick selection of the desired application.

**Off-line analysis software**

The software runs on standard PCs and permits comprehensive analysis of stored ANT results. After loading the results, the ANT settings during the measurement and the stored results can be accessed. Zoom and filter functions allow detailed evaluation. The processed results can be exported in CSV format for importing into other programs such as MS Excel or MS Word for Windows for producing documentation.

**Touch screen display**

Color TFT screen 10.4", 256 colors  
Resolution 640 x 480 pixels (VGA standard)

The touch screen allows very easy point and shoot operation.

**Built-in PC**

ANT family uses a Pentium PC as internal controller so that standard PC applications can also be run on the instrument.

RAM capacity 128 MB  
Hard disk drive 30 GB  
USB interface, 10/100 Mbit Ethernet interface are included

**Keyboard**

Full keyboard for text input, extended PC applications and future requirements. The keyboard is protected by a fold back cover.

An additional connector is provided for a standard PC keyboard.

**External display connector**

Simultaneous display with built-in screen

Interface VGA standard

**PCMCIA interface**

Type PCMCIA 2.1 types I, II and III

The PCMCIA interface provides access to GPIB, LANs, etc., via adapter cards.

**Power outage function**

In the event of an AC line power failure during a measurement, ANT family saves all data. As soon as the AC line voltage is reestablished, the measurement is resumed. Previous results are retained and the time of the power failure is recorded along with other events.

**Optical connectors**

Optical connectors adapters included in the packages according to the number of optical interfaces, optical connector types need to be selected

**General specifications**

**Power supply**

AC line voltage, Automatic switching 100 to 127 V and 220 to 240 V  
AC line frequency 50/60 Hz  
Power consumption ANT-20 (all options fitted) max. 300 VA  
Power consumption ANT-20se/ANT-10G (all options fitted) max. 600 VA  
Safety class to IEC 1010-1 class I

**Ambient temperature**

Nominal range of use +5 to +40 °C  
Storage and transport range -20 to +70 °C  
ANT-20 dimensions (w x h x d) in mm approx. 320 x 350 x 170  
inches approx. 12.6 x 13.8 x 6.7

ANT-20 weight approx. 10 kg/22 lb  
ANT-20se/ANT-10G  
Dimensions (w x h x d) in mm approx. 320 x 350 x 280 mm  
inches approx. 12.6 x 13.8 x 11 in  
ANT-20se/ANT-10G weight approx. 15 kg/33 lb

**Automatic modes**

**Autoconfiguration**

The autoconfiguration routine automatically sets the ANT to the input signal. ANT searches at the electrical and optical interfaces for the presence of standard PDH/DSn and STM-N/OC-N signals (G.703, G.707, O.151, O.181, GR-253, ANSI T1.102) and the payload contents in channel 1.

**Automatic SCAN function**

The SCAN function permits sequential testing of all C11/VT1.5 or C12/VT2 channels via AU-3 or AU-4 in a SDH/SONET signal.

The ANT receiver checks for alarms in the receive signal, the SDH/SONET structure and all channels, and for synchronization of the selected test pattern in all channels. The results (OK/not OK) for each channel are entered in a matrix. The generator runs simultaneously and can be used to stimulate the device under test.

**Automatic TROUBLE SCAN function**

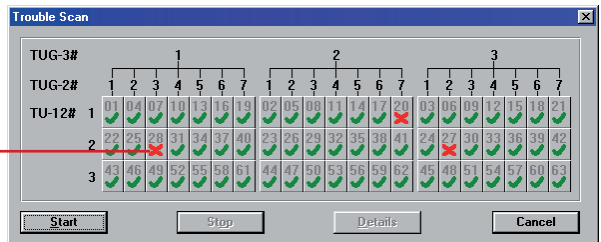
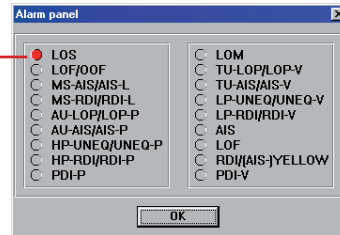

Trouble scan

The TROUBLE SCAN function permits sequential testing of all C11/VT1.5 or C12/VT2 channels via AU-3 or AU-4 in a SDH/SONET signal. The ANT receiver checks for alarms in the receive signal, the SDH/SONET structure and all channels. The results (OK/not OK) for each channel are entered in a matrix. A detailed alarm history can be displayed by selecting a channel from the matrix. The alarm status of individual channels can be displayed following the measurement. Only the receive channels are altered during a TROUBLE SCAN.

## AutoScan function

This automatic „AutoScan“ function allows you to rapidly check the signal structure, the mapping used and the payload -- even with mixed mapped signals. The ANT receiver analyzes the incoming received signal and provides a clear overview of all the signals present in the composite receive signal. The variable scan depth setting enables even complex signal structures to be resolved and displayed clearly. Even Trace Identifiers are evaluated. All the displayed results can be printed out.

## Automatic SEARCH function

Channel shifts in the payload may occur when measuring complex network elements, depending on the configuration of the device under test. The SEARCH function permits rapid automatic location of the test channel (C11/VT1.5 or C12/VT2 with defined PRBS) in the payload of a SDH signal. The ANT receiver checks for alarms in the receive signal, the SDH structure and all channels, and for synchronization of the selected test pattern in all channels. The results (OK/not OK) for each channel are entered in a matrix. An OK result indicates that the corresponding channel contains the signal searched for. Only the receive channels are altered during a SEARCH.

## AUTO/Remote

### V.24/RS232 remote control interface

Remote control of instrument functions using SCPI command structure

Interface	V.24/RS232
-----------	------------

### TCP/IP remote control interface

Remote control of instrument functions using SCPI command structure

Interface	10/100 Mb/s Ethernet
-----------	----------------------

## LabWindows driver

Simplifies creation of remote-control programs for automated testing using LabWindows. The drivers can be used with the included V.24/RS232 remote control interface and with the option BN 3035/92.10 (GPIB interface).

## Optical Interfaces

ANT family provides optical interfaces from STM-0/OC-1 to STM-64/OC-192. This includes SDH and SONET signal generation, error and alarm insertion, and SOH/TOH manipulation.

All the optical interfaces are intended for single-mode fibers. JDSU offers a complete line of optical test adapters. Select one test adapter each for the generator and receiver from the ordering information in this data sheet. All optical interface options include the required number of test adapters.

### Optical interfaces 155 Mb/s

(included in all packages except: BN 3060/72 and BN 3060/82)

#### Optical STM-0/1, OC-1/3, 1310 and 1550 nm

Bit rate of TX and RX signal	155520 kb/s
Additionally, for STS-1/STM-0 mappings	51840 kb/s
Line code	scrambled NRZ

#### Generator

The generator meets the requirements of ITU-T Rec. G.957, tables 2 and 3 (Telcordia GR-253, ANSI T1.105.06).

Classes L1.1, L1.2 and L1.3 (LR-1, LR-2, LR-3) are covered.

Wavelength 1310 and 1550 nm (software switchable in the instrument)

Output level	0 dBm +2/-3.5 dB
--------------	------------------

#### Receiver

The receiver meets the specifications of ITU-T Rec. G.957 (Telcordia GR-253, ANSI T1.105.06) and fulfills classes S1.1 and S1.2 (IR-1, IR-2).

Wavelength range	1100 to 1580 nm
Input sensitivity	-28 to -8 dBm (-34 to -8 dBm typ.)

#### Display of optical input level

Resolution	1 dB
------------	------

155 Mb/s electrical interface for connecting the ANT family to STM-1/STS-3 monitor points

Line code	scrambled NRZ
Input voltage (peak-peak)	0.2 to 1 V

#### Unbalanced input

Connector/impedance	SMA/50 Ω
---------------------	----------

### Optical interfaces 622 Mb/s

(included in all packages except: BN 3035/06, 3060/72 and 3060/82)

#### Optical STM-0/1/4, OC-1/3/12, 1310 and 1550 nm

Bit rate of TX and RX signal	155520 kb/s, 622080 kb/s
Additionally, for STS-1/STM-0 mappings	51840 kb/s
Line code	scrambled NRZ

## 12

**Generator**

The generator meets the requirements of ITU-T Rec. G.957, Tables 2 and 3 (Telcordia GR-253, ANSIT1.105.06).

Classes L1.1, L1.2, L1.3, L4.1, L4.2 and L4.3 (LR-1, LR-2, LR-3) are covered.

Wavelength	1310 and 1550 nm (software switchable in the instrument)
Output level	0 dBm +2/-3.5 dB

**Generation of STM-4 TX signal**

The STM-4 TX signal consists of:

- four identical STM-1 tributary signals (AU-4), or
- one internally generated STM-1 tributary signal with the other three tributaries filled with UNEQ.

**Generation of OC-12 TX signal**

The OC-12 TX signal consists of:

- one internally generated STS-1 tributary signal with the other 11 tributaries filled with UNEQ or
- one internally generated STS-3c tributary signal with the other three tributaries filled with UNEQ.

**Contents of the STM-4/OC-12 overhead bytes**

For all bytes except B1, B2 and H1 to H3:

The content of each byte is statically programmable or a user defined byte-sequence p in m in n (p frames in m frames and the entire sequence repeated n times) can be inserted.

For the E1, E2, F1 bytes and the DCC channels D1 to D3 and D4 to D12:

Transmission of a test pattern with bit error insertion (see mainframe for pattern selection)

**Insertion of an external data signal (via the V.11 interface)**

For the K1, K2, N1, N2 bytes:

Insertion of the data signal via the V.11 interface

For the J0 bytes:

Transmission of a 16-byte sequence, with CRC

**Error insertion**

Error types	B1 and B2 parity error
Additionally, for STM-4 for OC-12	MS-REI REI-L

**Triggering**

Single errors or error ratio for B1 parity errors	$2 \times 10^{-3}$ to $1 \times 10^{-10}$ $2 \times 10^{-4}$ to $1 \times 10^{-10}$
---	--

**Burst error: m anomalies in n periods**

For FAS, B1, B2, B3, REI-L, REI-P  
m = 1 to  $4.8 \times 10^6$  and  
n = 2 to 8001 frames or 0.2 s to 600 s

**Alarm generation, dynamic**

Alarm types for STM-4 for OC-12	LOF, MS-AIS, MS-RDI LOF, AIS-L, RDI-L
m alarms in n frames or	m = 1 to n-1, nmax = 8000
t1 alarm active, t2 alarm passive	t1 = 0 to 60 s, t2 = 0 to 600 s

**Alarm generation, static (on/off)**

Alarm types	LOS, LOF
Additionally, for STM-4 for OC-12	MS-AIS, MS-RDI, RS-TIM AIS-L, RDI-L, TIM-L
Insertion on/off	

**Receiver**

The receiver meets the specifications of ITU-T Rec. G.957 (Telcordia GR-253, ANSI T1.105.06) and fulfills classes S1.1, S1.2, S4.1, S4.2, L4.1, L4.2 and L4.3 (IR-1, IR-2, LR-1, LR-2, LR-3).

Wavelength range	1100 to 1580 nm
Input sensitivity, STM-1/4, OC-1/3/12-8 to -28 dBm (-8 to -34 dBm typ.)	

Display of optical input level

Resolution	1 dB
------------	------

The ANT family demultiplexes one selectable STM-1 or STS-3c/STS-1 tributary from the STM-4 or OC-12/OC-3 RX signal and feeds it to the internal processor for evaluation.

**Error measurements**

Error types	B1 parity error, B2 parity error of all STM-1/STS-1/STS-3c signals, MS-REI/REI-L
-------------	--

**Alarm detection**

Alarm types for STM-4 for OC-12	LOS, LOF, OOF, LTI MS-AIS, MS-RDI, RS-TIM AIS-L, RDI-L, TIM-L
---------------------------------	---

**Overhead evaluation**

Display of the complete overhead of a selectable STM-1/STS-1/STS-3c signal

For the E1, E2, F1 bytes and the DCC channels D1 to D3 and D4 to D12:

BERT using a test pattern from the generator

Output of the data signal via the V.11 interface

For the K1, K2, N1, N2 bytes:

Data signal output via the V.11 interface

For the J0 byte:

Display of 15-byte sequences in ASCII.

**155/622 Mb/s electrical interface**

For connecting the ANT family to STM-1/OC-3 and STM-4/OC-12 monitor points

Line code	scrambled NRZ
Input voltage (peak-peak)	0.2 to 1 V

**Coaxial input**

Connector/impedance	SMA/50 Ω
---------------------	----------

**Concatenated mapping OC-12c/STM-4cBERT**

Contiguous concatenation signal structure to ANSI T1.105.02 and G.707.

*Error measurement to O.150*

Test pattern	PRBS-31, IPRBS-31, PRBS-23, IPRBS-23, PRBS-20, PRBS-15, IPRBS-15
--------------	--

Programmable word:

Length	16 bits
--------	---------

Error insertion:

Bit errors in test pattern, single error or error ratio	$1 \times 10^{-2}$ to $1 \times 10^{-9}$
---	--

Error measurement and alarm detection:

Bit errors and AIS in test pattern

**Optical interfaces 2.5 Gb/s**

(included in packages: BN 3035/57, 3035/58, 3060/71, 3060/74, 3060/81 and 3060/84)

The optical interfaces meet the specifications of ITU-T Recommendation G.957 (Table 4) and Telcordia TA-NWT-000253 I.6 (Table 4-9, 4-10). Classes S-16.2, L-16.2, L-16.3 (ITU-T) or IR-2, LR-2, LR-3 (Telcordia) are fulfilled at 1550 nm; classes S-16.1, L-16.1 (G.957) or IR-1, LR-1 (Telcordia) are fulfilled at 1310 nm.

**Generator***Optical interfaces*

Wavelengths	1310/1550 nm software switchable
Output level at 1310 nm and 1550 nm	0 dBm +0/-2 dB
Line code	scrambled NRZ

*Electrical interfaces*

Line code	scrambled NRZ
Output voltage (peak-peak)	$\geq 0.6$ V
Connector/impedance	SMA/50 $\Omega$

*Clock generator*

Internal, accuracy	$\pm 2$ ppm
Offset	$\pm 50$ ppm

Synchronization from external signal as for mainframe

*Generation of STM-16 TX signal*

In instruments with STM-1 mappings

The STM-16 signal consists of one or more internally generated tributaries plus several tributaries filled with UNEQ (or non-specific UNEQ)

- 16 identical STM-1
- One STM-1 tributary and 15 x UNEQ/non specific
- 4 identical STM-4c
- One STM-4c tributary and 3 x UNEQ/non specific

*Generation of OC-48 TX signal*

In instruments with STS-1/STS-3c mappings

The OC-48 signal consists of one or more internally generated tributaries plus several tributaries filled with UNEQ (or non-specific UNEQ)

- 48 identical STS-1
- One STS-1 tributary and 47 x UNEQ/non specific
- 16 identical STS-3c
- One STS-3c tributary and 15 x UNEQ/non specific
- 4 identical STS-12c
- One STS-12c tributary and 3 x UNEQ/non specific

*Contents of STM-16/OC-48 overhead bytes*

For all bytes except B1, B2 and H1 through to H3:

The contents of the bytes in all SOH/TOH are statically programmable

For the bytes E1, E2, F1 and the DCC channels D1 to D3 and D4 to D12: Transmission of a test pattern and bit error insertion (see mainframe for pattern selection)

Insertion of an externally-generated data signal (via V.11 interface)

For the K1, K2, N1, N2 bytes:

Insertion of an external data signal via the V.11 interface

For the J0 byte:

Transmission of a 16-bit sequence with CRC

*Error insertion*

Error types	B1, B2 parity errors
Single error or error rate B1	$1 \times 10^{-10}$ to $2 \times 10^{-5}$
B2	$1 \times 10^{-10}$ to $2 \times 10^{-3}$
Additionally, for STM-16 for OC-48	MS-REI REI-L
Single error or error rate	$1 \times 10^{-10}$ to $2 \times 10^{-3}$

*Alarm generation, dynamic*

Alarm types for STM-16 for OC-48	LOF, MS-AIS, MS-RDI LOF, AIS-L, RDI-L
m alarms in n frames	$m = 1$ to $n-1$ , $n_{max} = 8000$
or	
t1 alarm active, t2 alarm passive	$t1 = 0$ to 60 s, $t2 = 0$ to 600 s

*Alarm generation, static (on/off)*

Alarm types	LOS, LOF
Additionally, for STM-16 for OC-48	MS-AIS, MS-RDI AIS-L, RDI-L

**Receiver***Optical interfaces*

Wavelength	1260 to 1580 nm
Line code	scrambled NRZ
Sensitivity	-28 to -8 dBm
Input overload	>-8 dBm

*Display of optical input level*

Range	-30 to -8 dBm
Resolution	1 dB



**Electrical interfaces**

Line code	scrambled NRZ
Input voltage (peak-peak)	0.3 to 1 V
Connector/impedance	SMA/50 Ω

A selectable STM-1, STS-1 or STS-3c channel is fed to the internal evaluation circuits by demultiplexing from the input signal.

**Error measurement**

Error types	B1 parity error, MS-REI, B2 parity sum error over all STM-1/STS-1/STS-3c channels
Evaluation (bit/block errors)	error rate, count
Error event resolution	1 s

**Alarm detection**

Alarm types	LOS, LOF, OOF
Additionally, for STM-16 for OC-48	MS-AIS, MS-RDI, RS-TIM AIS-L, RDI-L, TIM-L
Alarm event resolution	100 ms

**SOH/TOH evaluation**

Display of complete overhead

For the bytes E1, E2, F1 and the DCC channels D1 to D3 and D4 to D12:  
BERT using test pattern from generator  
Output of the data signal via the V.11 interface

For the K1, K2, N1, N2 bytes:

Data signal output via the V.11 interface

For the J0 byte:

Display of 15-byte sequences in ASCII format

**Concatenated mapping OC-48c/STM-16c BERT**

Contiguous concatenation signal structure to ANSI T1.105.02 and G.707.

**Error measurement to O.150**

Test pattern	PRBS-31, IPRBS-31, PRBS-23, IPRBS-23
--------------	--------------------------------------

**Programmable word**

Length	16 bits
--------	---------

**Error insertion**

Bit errors in test pattern, single error or error ratio  $1 \times 10^{-3}$  to  $1 \times 10^{-9}$

Alarm generation

AU-AIS, AIS-C1...AIS-C16, AU-LOP, LOP-C1...LOP-C16

**Error measurement and alarm detection**

AU-AIS, AU-LOP

**Bit errors**

Automatic protection switching

Sensor: MS-AIS, AU-AIS

**Optical interfaces 10 Gb/s**

(included in all ANT-10G packages: BN 3060/71, 3060/72, 3060/73, 3060/74, 3060/81, 3060/82, 3060/83 and 3060/84)

**Generator STM-64**

The transmitter of the optical interface meets the specification of ITU-T G.691 (Table 5A, 5B) Application code: S-64.2b, S-64.3b, S-64.5b and I-64.2r, I-64.2, I-64.3, I-64.5, S-64.3a, S-64.5a with additional optical attenuator 1 to 3 dB and Telcordia GR-1377 (Table 4-4, 4-5, 4-6)

Parameter: SR-2, LR-2 (a and c), IR-2, IR-3

**Optical interface**

Wavelengths	1550 nm or 1310/1550 nm switchable
Output level at 1310 nm	0 dBm ± 1 dB
Output level at 1550 nm	0 dBm ± 1 dB
Line code	scrambled NRZ

**Clock generator**

Internal, accuracy	± 2 ppm
Offset	± 50 ppm

Synchronization from external signal

**Generation of STM-64 signal**

compliant to ITU-T G.707

One test channel STM-1 with standard mappings or STM-4c bulk or STM-16c bulk, others unequipped or same as test channel

Additionally generation of OC-192 signal compliant to GR-253 one test channel STS-3c or STS-12c or STS-48c SPE BERT, others unequipped or same as test channel

**Contents of STM-64 overhead bytes**

For all bytes except B1, B2, H1 to H3	statically programmable
For bytes E1, E2, F1, D1 to D3 and D4 to D12	test pattern
For bytes K1, K2	external data via V.11
For J0 byte	external data via V.11
For J0 byte	16 byte sequence ASCII with CRC

**Byte sequence**

m in n in p for bytes of first 16 STM-1 SOH m times (1 to 200 000 000) byte A followed by n times (1 to 2 000 000 000) byte B sequence repetition p (1 to 65 000)

**Error insertion**

Error types B1, B2, MS-REI	single and rate
Burst errors: m anomalies in n periods	m = 1 to $4.8 \times 10^6$
	and n = 2 to 8001 frames or 0.2 s to 600 s

**Alarm generation****Alarm types**

LOS, LOF, MS-AIS, MS-RDI, RS-TIM	on/off
Dynamic alarms	

m alarms in n frames LOF, MS-AIS, MS-RDI m = 1 to n --1, nmax = 8000 or active = 0 to 60 s, passive = 0 to 600 s

Frame trigger [100]

Output voltage (open circuit)	CMOS
Connector/impedance	BNC/approx. 50 $\Omega$

#### Analyzer STM-64

The receiver of the optical interface meets the specification of Telcordia GR-1377 (Table 4-4, 4-5) Parameter: SR-2, IR-2, IR-3 and ITU-T G.691 (Table 5A, 5B) Application code: S-64.2b, S-64.3b, S-64.5b, I-64.2r, I-64.2, I-64.3, I-64.5

#### Optical interface

Wavelengths	1260 to 1360 nm and 1520 to 1580 nm
Sensitivity at 1310 nm	-12 to 0 dBm
Sensitivity at 1550 nm	-15 to 0 dBm
Line code	scrambled NRZ
Offset range	$\pm$ 500 ppm

#### Demultiplexing of STM-64 signal

compliant to ITU-T G.707

Evaluation of one selectable channel STM-1 down to the mapped tributary or STM-4c SPE or STM-16c.

Additionally demultiplexing of OC-192 signal compliant to Telcordia GR-253.

Evaluation to one selectable channel STM-4c or STM-16c.

#### Concatenated mappings OC-192c/STM-64c BERT

Contiguous concatenation signal structure to ANSI T1.105.02 and G.707.

#### Error measurement to O.150

Test pattern	PRBS-31, IPRBS-31
--------------	-------------------

#### Programmable word

Length	16 bits
--------	---------

#### Error insertion

Bit errors in test pattern, single error or error ratio	$1 \times 10^{-3}$ to $1 \times 10^{-9}$
Alarm generation	AU-AIS, AU-LOP

#### Error measurement and alarm detection

AU-AIS, AU-LOP

Bit errors

#### Option electrical interfaces at 9953 Mb/s

(option to be ordered for ANT-10G only and only at initial purchase, upgrade later on not possible)

#### Electrical interfaces at 10 Gb/s for 1550 nm packages BN 3060/91.48

#### Electrical interfaces at 10 Gb/s for dual wavelength packages BN 3060/91.54

This option must be ordered with the mainframe as a subsequent upgrade is not possible.

#### Generator

Output level (peak-peak)	400 to 600 mV
Connector/impedance	SMA/50 $\Omega$

#### Receiver

Input level (peak-peak)	100 to 600 mV
Connector/impedance	SMA/50 $\Omega$

#### Clock

Frequency	9953.28 MHz
Tx output level (peak-peak)	$\geq$ 450 mV
Rx output level (peak-peak)	$\geq$ 470 mV
Connector/impedance	SMA/50 $\Omega$

## Jitter and Wander Options

The Jitter/Wander modules are optimized for compliance with the latest standard (O.172) and assure reliable jitter and wander measurements, useful when analyzing pointer jitter in up to 10 Gb/s systems, for example. ANT-10G is particularly adept at wander analysis. The graphical MTIE wander analysis requires no external computing resources and allows rapid verification of the synchronicity of a SDH network. Jitter/wander components are available for all built-in bit rates.

### Standards

Jitter generation and jitter/wander analysis are in accordance with:

Telcordia GR-253, GR-499, GR-1244

ANSI T1.101, T1.102, T1.105.03, T1.403, T1.404, T1.105.09

ITU-T G.783, G.823, G.824, G.825, O.171, O.172

ETSI ETS 300 462-1 to -6, ETS 300 417-1-1, EN 302 084

Clock rate/kHz	A1	A2	f1/Hz	f2/Hz	f3/kHz
1 544	0.5	64	0.1	625	80
2 048				1560	200
6 312				940	120
8 448				6250	800
34 368				27 k	3 500
44 736				35 k	4 500
51 840				27 k	3 500
139 264				39 k	5 000
155 520				39 k	5 000
622 080*				1.0	256

\* Requires option BN 3035/91.31

### Option O.172 Jitter/Wander up to 155 Mb/s

(options only for ANT-20 and ANT-20se) BN 3035/91.29 (included in the ANT-10G packages: BN 3060/72, 3060/73, 3060/82 and 3060/83)

#### Jitter generator

Fully complies with or exceeds the requirements of ITU-T O.172.

#### Bit rates

Generates jitter at all bit rates included in the mainframe configuration up to 155520 kb/s.

TX signals	all test patterns and frame structures included in the mainframe configuration
Built-in modulation generator (sine wave)	0.1 Hz to 5 MHz
External modulation	0 Hz to 5 MHz
Jitter amplitude	up to 64 UI

#### Modulator input

75 Ω, BNC socket	
Voltage required	0 to 2 Vpp
Error limits	as per O.172

#### Jitter analyzer

Jitter measurement at all bit rates included in the mainframe configuration up to 155520 kb/s.

#### Built-in filters

High-pass filters	0.1, 2, 4, 10, 20, 40, 100, 200, 400, 500, 700 Hz, 1, 3, 8, 10, 12, 18, 20, 30, 65, 80, 250 kHz
Low-pass filters	40, 60, 100, 400, 800, 1300, 3500, 5000 kHz
Filter characteristics	as per O.172

#### Measurement ranges

##### Peak-peak

Range I, Resolution	0 to 1.6 UIpp, 1 mUIpp
Range II, Resolution	0 to 20 UIpp, 10 mUIpp
Range III, Resolution	0 to 200 UIpp, 100 mUIpp

##### RMS

Range I, Resolution	0 to 0.8 UIpp, 1 mUIpp
Range II, Resolution	0 to 10 UIpp, 10 mUIpp
Range III, Resolution	0 to 100 UIpp, 100 mUIpp
Measurement accuracy	as per O.172

#### Demodulator output

##### 75 Ω, BNC socket

Range I (0 to 1.6 UIpp)	1 V/UIpp
Range II (0 to 20 UIpp)	0.1 V/UIpp
Range III (0 to 200 UIpp)	0.01 V/UIpp

#### Wander generator

Fully complies with or exceeds the requirements of ITU-T O.172

#### Bit rates

Wander generation at all implemented bit rates up to 155 Mb/s according to the equipment level of the instrument.

Amplitude range	up to 200000 UI
Frequency range	10 μHz to 10 Hz
Accuracy	as per O.172
Resolution	1 μHz

#### Wander analyzer

Fully complies with or exceeds the requirements of ITU-T O.172

For all bit rates up to 155 Mb/s according to the equipment level of the instrument.

Other sampling rates in addition to the 30/s rate are available for detailed analysis versus time:

Sampling rate -- low-pass filter -- test duration	1/s - 0.1 Hz - 99 days; 30/s - 10 Hz - 99 h 60/s - 20 Hz - 99 h; 300/s - 100 Hz - 5000 s
Amplitude range	± 1 ns to ± 1 μs
Measurement accuracy	as per O.172
Accessory: "Standard Frequency Source" for wander applications, see end of chapter	

## Option O.172 Jitter/Wander at 622 Mb/s

(options only for ANT-20 and ANT-20se) BN 3035/91.31 (included in the ANT-10G packages: BN 3060/72, 3060/73, 3060/82 and 3060/83)

### Jitter generator

Jitter modulation of STM-4 TX signals.

Built-in modulation generator (sine wave)	0.1 Hz to 5 MHz
External modulation	0 Hz to 5 MHz
Jitter amplitude	up to 256 UI

Jitter modulation of externally-generated signals in through mode

Externally-generated signals can be jittered in Through mode when the D&I option is included.

This applies to all bit rates included in the mainframe configuration at the appropriate electrical and optical interfaces.

Built-in modulation generator (sine wave)	0.1 Hz to 5 MHz
External modulation	0 Hz to 5 MHz
Jitter amplitude	as for jitter generator in UIpp

### Jitter analyzer

#### Measurement range

##### Peak-peak

Range I, Resolution	0 to 6.4 UIpp, 1 mUIpp
Range II, Resolution	0 to 80 UIpp, 10 mUIpp
Range III, Resolution	0 to 800 UIpp, 100 mUIpp

##### RMS

Range I, Resolution	0 to 3.2 UIpp, 1 mUIpp
Range II, Resolution	0 to 40 UIpp, 10 mUIpp
Range III, Resolution	0 to 400 UIpp, 100 mUIpp
Measurement accuracy	as per O.172

#### Demodulator output

75 Ω, BNC socket

Range I (0 to 6.4 UIpp)	0.25 V/UIpp
Range II (0 to 80 UIpp)	0.025 V/UIpp
Range III (0 to 800 UIpp)	0.0025 V/UIpp

### Wander generator

Fully complies with or exceeds the requirements of ITU-T O.172.

#### Bit rates

Wander generation at all implemented bit rates up to 622 Mb/s according to the equipment level of the instrument.

Amplitude range	up to 200000 UI
Frequency range	10 μHz to 10 Hz
Accuracy	as per O.172
Resolution	1 μHz

### Wander analyzer

Fully complies with or exceeds the requirements of ITU-T O.172.

Other sampling rates in addition to the 30/s rate are available for detailed analysis versus time:

Sampling rate -- low-pass filter -- test duration	1/s - 0.1 Hz - 99 days; 30/s - 10 Hz - 99 h 60/s - 20 Hz - 99 h; 300/s - 100 Hz - 5000 s
Amplitude range	± 1 ns to ± 1 ms
Measurement accuracy	as per O.172

#### Reference signal input

Frequencies	1.544, 2.048, 5, 10 MHz
Bit rates	1.544, 2.048 Mb/s
Balanced 110 Ω connector	Bantam
Clock input voltage (sine or square wave)	1.0 to 6.5 Vpp
HDB3/B8ZS input voltage	± 3 V ± 10%
Coaxial 75 Ω connector	BNC

#### Clock input voltage

(sine or square wave)	1.0 to 5 Vpp
HDB3/B8ZS input voltage	± 2.37 V ± 10%

Accessory: "Standard Frequency Source" for wander applications, see end of chapter

## Option O.172 Jitter/Wander at 2488 Mb/s

(options only for ANT-20se) BN 3035/91.32

### Jitter generator

Fully complies with or exceeds the requirements of ITU-T O.172.

Bit rate	2488320 kb/s
Generator signal test patterns, frame structures, depend on instrument configuration	

Built-in modulation generator sine wave or external	0.1 Hz to 20 MHz
Jitter amplitude	up to 800 UI

Bit rate/kHz	A1/ UIpp	A2/ UIpp	A3/ UIpp	A4/ UIpp	f0/Hz	f1/Hz	f2/Hz	f3/Hz	f4/Hz
--------------	----------	----------	----------	----------	-------	-------	-------	-------	-------

2488320									
ANT-20se	0.008	0.75	20	800	0.1	12.1	500	750 k	20 M

#### Modulator input

75 Ω, BNC socket

Modulation frequency	0.1 Hz to 20 MHz
Required sinusoidal voltage	0 to 2.0 Vpp
Error limits	as per ITU-T O.172

Jitter modulation of external signals in through mode

In Through mode, jitter can be superimposed on an external 2488 Mb/s signal in conjunction with the D&I option.

Internal and external modulation, jitter amplitude see jitter generator

### Jitter analyzer

Bit rate	2488320 kb/s
----------	--------------

#### Measurement ranges

Range I, Resolution	0 to 2 UIpp, 1 mUIpp
Range II, Resolution	0 to 32 UIpp, 10 mUIpp
Range I, Resolution	0 to 1.0 UIpp, 1 mUIpp
Range II, Resolution	0 to 16 UIpp, 10 mUIpp

#### Built-in filters

as per ITU-T O.172, G.825, G.813, Telcordia GR-253, ANSI T1.105.03

High-pass filters	5 kHz, 12 kHz, 1 MHz
Low-pass filters	20 MHz

The high-pass filters can be switched off.

Frequency range without high-pass filter

Measurement range I	80 Hz
Measurement range II	10 Hz
Measuring modes	see jitter analysis

**Demodulator output**

75 Ω, BNC socket

**Output voltage**

Measurement range I (0 to 2 UIpp)	1 V/UIpp
Measurement range II (0 to 32 UIpp)	62.5 mV/UIpp
Automatic tests	like jitter meter up to 622 Mb/s
Tolerance masks at	
MTJ/F-MTJ	ITU-T G.825 (ANSI T1.105.03 and Telcordia GR-253)
JTF	ITU-T G.958 (Telcordia GR-253 and ANSI T1.105.03 type A)

**Wander generator**

Fully complies with or exceeds the requirements of ITU-T O.172.

Amplitude range	up to 200000 UI
Frequency range	10 μHz to 10 Hz
Accuracy	as per O.172
Resolution	1 μHz

**Wander analyzer**

Other sampling rates in addition to the 30/s rate are available for detailed analysis versus time:

Sampling rate – low-pass filter – test duration	1/s - 0.1 Hz - 99 days; 30/s - 10 Hz - 99 h 60/s - 20 Hz - 99 h; 300/s - 100 Hz - 5000 s
Amplitude range	± 1 ns to ± 106 s
Measurement accuracy	as per O.172

**Evaluation capabilities**

See wander analysis.

**Reference signal input**

75 Ω, BNC socket

Frequencies	1544, 2048, 5, 10 MHz
Input voltage	0.5 to 5 Vpp
Input signal monitoring (loss of timing input)	LTI
Accessory: "Standard Frequency Source" for wander applications, see end of chapter	

**O.172 Jitter/Wander at 9953 Mb/s**

(included in the ANT-10G packages: BN 3060/72, 3060/73, 3060/82 and 3060/83, below specs without the wander generator also included in the ANT-10G packages: BN 3060/74 and BN 3060/84)

**Jitter generator**

Fully complies with or exceeds the requirements of ITU-T O.172.

Bit rate	9953280 kb/s
Maximum offset	± 50 ppm
Built-in modulation generator sine wave or external	0.1 Hz to 80 MHz
Jitter amplitude	up to 3200 UIpp

Amplitude in UIpp			Frequency in Hz				
A1	A2	A3	f1	f2	f3	f4	f5
0.5	20	3200	0.1	12.5	2 k	2 M	80 M

**Modulator input**

75 Ω, BNC socket

Modulation frequency	0.1 Hz to 80 MHz
Input voltage range	0 to 2.0 Vpp
Error limits	as per ITU-T O.172

**Jitter analyzer**

Bit rate	9953280 kb/s
----------	--------------

**Measurement ranges****Peak-peak**

Range I, Resolution	0 to 4 UIpp, 1 mUIpp
Range II, Resolution	0 to 40 UIpp, 10 mUIpp
Range III, Resolution	0 to 3200 UIpp, 100 mUIpp

**RMS**

Range I, Resolution	0 to 2 UIpp, 1 mUIpp
Range II, Resolution	0 to 20 UIpp, 10 mUIpp
Range III, Resolution	0 to 1600 UIpp, 100 mUIpp
Measurement accuracy	as per O.172

**Built-in filters**

as per ITU-T O.172, G.825, G.813, Telcordia GR-1377, ANSI T1.101, T1.105.03

High-pass filters	10 kHz, 12 kHz, 20 kHz, 50 kHz and 4 MHz
Low-pass filters	10 kHz, 80 MHz

The high-pass filters can be switched off.

**Frequency range without high-pass filter**

Measurement range I	100 Hz
Measurement range II	10 Hz
Measurement range III	10 Hz

**Demodulator output**

75 Ω, BNC socket

**Output voltage**

Measurement range I (0 to 4 UIpp)	0.5 V/UIpp
Measurement range II (0 to 40 UIpp)	50 mV/UIpp
Measurement range III (0 to 3200 UIpp)	0.625 mV/UIpp

**Wander generator**

Fully complies with or exceeds the requirements of ITU-T O.172.

Bit rate	9953280 kb/s
Amplitude range	0.1 UI to 320000 UI
Frequency range	10 μHz to 10 Hz
Accuracy	as per O.172
Resolution	1 μHz

**Wander analyzer**

Fully complies with or exceeds the requirements of ITU-T O.172

Other sampling rates in addition to the 30/s rate are available for detailed analysis versus time:

Sampling rate -- low-pass filter -- test duration	1/s - 0.1 Hz - 99 days; 30/s - 10 Hz - 99 h 60/s - 20 Hz - 99 h; 300/s - 100 Hz - 5000 s
Amplitude range	± 1 ns to ± 1 μs
Measurement accuracy	as per O.172



## 19

**Reference signal input**

Frequencies	1.544, 2.048, 5, 10 MHz
Bit rates	1.544, 2.048 Mb/s

**Balanced 110Ω connector**

Clock input voltage (sine or square wave)	0.65 to 6.5 Vpp
HDB3/B8ZS input voltage 3	± 3 V ± 10%

**Coaxial 75Ω connector**

Clock input voltage (sine or square wave)	0.5 to 5 Vpp
HDB3/B8ZS input voltage	± 2.37 V ± 10%

For “Standard Frequency Source” accessory for wander applications, see end of section.

**Jitter and Wander measurement modes****Jitter analysis**

Current values (continuous measurement)

Peak jitter value	in UIpp
Positive peak value	in UI+p
Negative peak value	in UI-p

Maximum value (gated measurement)

Maximum peak jitter value	in UIpp
Maximum positive peak value	in UI+p
Maximum negative peak value	in UI-p
Result averaging (switchable)	1 to 5 s

The ANT-10G retains phase synchronicity even when pointer jitter occurs (phase tolerance to O.172).

**Phase hits**

The instrument detects when the programmable threshold for positive and negative jitter values is exceeded.

The result indicates how often this threshold was exceeded.

Setting range for positive and negative thresholds (depending on measurement range) 0.1 up to the half measurement range

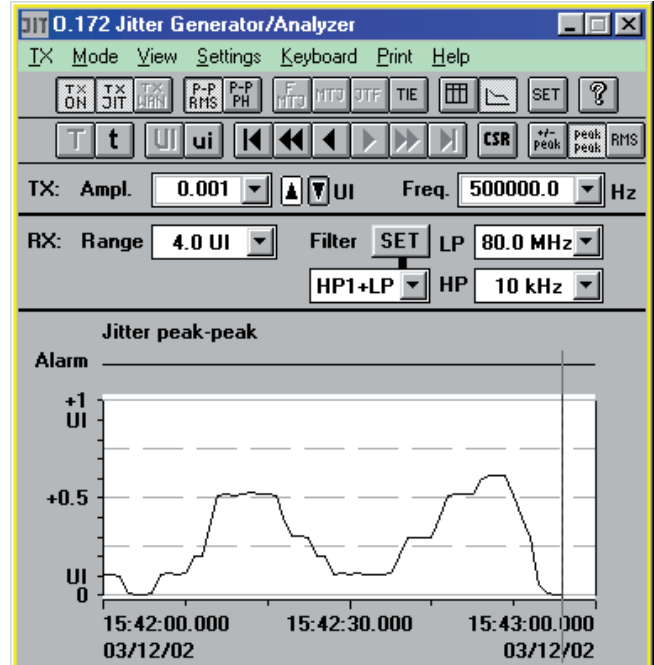
**Jitter versus time**

Jitter versus time display

This function is used to record variations of jitter with time.

It allows the positive and negative peak values or peak-to-peak values to be displayed versus time.

Measured values have one second resolution. Measurement duration is up to 99 days. By simultaneously evaluating alarms and errors, correlations between events can be quickly identified.

**Clock jitter measurement**

The ANT-10G can also measure the jitter on the clock signals (square-wave) at standard bit rates. All built-in bit rates with electrical interfaces up to 155 Mb/s can be measured (requires option BN 3060/91.30) or BN 3060/91.31).

**RMS measurement**

*T1.105.03, GR-253, GR-499, G.958 (or G.783 rev.)*

The RMS value is measured on-line and displayed in UI. The peak jitter and RMS values can be displayed simultaneously; a graph versus time is available for long-term analysis. An RMS filter preset is available.

**Wander analysis****Time interval error (TIE)**

To O.172 numerical and graphical  
Sampling rates please see under O.172 Wander Analyzer  
MTIE is additionally determined as a continually updated numerical value.

To prevent data loss or premature termination of long term measurements, the ANT-10G checks the remaining space on the hard disk before the start of the measurement. If necessary, the selected measurement time can be adjusted.

The TIE values are recorded and are then available for subsequent off-line MTIE/TDEV evaluations. The values are also saved in .csv format for documentation or further analysis.

**MTIE/TDEV off-line analysis evaluation**

This software provides extended off-line statistical analysis facilities for the results of wander measurements.

TIE values results obtained using the ANT-10G are analyzed according to ANSIT1.101, Telcordia GR-1244, ETSI ETS 300 462, EN 302 084, ITU-T O.172, G.810 to G.813.

Network synchronization quality is presented graphically using the MTIE (Maximum Time Interval Error) and TDEV (Time DEVIation) parameters. To ensure correct assessment, the tolerance masks for PRC (Primary Reference Clock), SSU (Synchronization Supply Unit), SEC (Synchronous Equipment Clock) or PDH can be superimposed.

The results and masks can be printed out with additional user-defined comments.

This software allows several TIE results to be displayed simultaneously.

Decisive details during long term measurements disappear in the multitude of results. An effective zoom function is available for detailed wander characteristic analysis.

**Result printout and export**

The results can be printed out and stored internally or on floppy disk. The file format allows further processing using standard PC software.

**Frequency offset and frequency drift rate (ANSIT1.101)**

To ensure reliable operation when a clock source is in holdover mode, the frequency characteristics must not exceed specific deviation limits relative to an absolute reference source. To verify this data, the ANT-10G determines the following over the selected measurement interval:

Frequency offset	in ppm
Frequency drift rate	in ppm/s

**MRTIE– Relative MTIE (G.823 and EN 302 084)**

If the reference is unavailable (too far away) when analyzing the wander of asynchronous signals, the MTIE analysis may have a superimposed frequency offset. This offset depends on the difference between the signal and local reference clocks. The MRTIE measurement subtracts the frequency offset from the result so that the „actual“ wander characteristic is shown.

**Accessory for wander analysis**

Standard frequency source please see end of chapter.

**Automatic measurements**

The following automatic measurements can be run for all standard bit rates and interfaces included in the mainframe configuration (electrical/optical) up to 10 Gb/s.

**Automatic determination of selective Jitter transfer function (JTF)**

*Telcordia GR-499, GR-253, ANSIT1.105.03, ITU-T G.958*

The Jitter transfer function indicates the ratio of the jitter amplitude at the output of the device under test to that at the input at various frequencies.

This determines whether the device under test reduces or amplifies input jitter and at which frequencies. After a calibration measurement to minimize intrinsic errors, the ANT-10G outputs a pre-selected jitter amplitude at various frequencies and measures selectively the jitter amplitude at the output of the device under test. The ratio of the amplitudes in dB is the Jitter Transfer Function. The pre-selected amplitudes correspond to the mask for maximum permitted input jitter. The jitter frequencies and amplitudes can also be edited. The calibration values can be saved and used again for other measurements.

**Additional measurement mode****Transfer MTJ results:**

An MTJ measurement is first performed. The measured amplitude values can then be used automatically as generator values for the JTF measurement.

The results can be displayed in tabular and graphical form.

The graphical display includes the standard tolerance masks specified in T1.105.03 and GR-253 or G.735 to G.739, G.751, G.758. The distance of the measurement points from the tolerance masks indicates the degree to which the device under test meets the requirements of the standard.

Tolerance mask violations during the measurement are indicated in the numerical table.

**Freely programmable tolerance masks**

The existing tolerance masks for the ANT-10G can be altered as required to suit requirements that do not conform to specific standards. The new values selected for jitter frequency and jitter gain/loss are stored when the application is saved.

*Automatic limit testing of maximum tolerable jitter (Fast Maximum Tolerable Jitter, F-MTJ)*

ANSI T1.403, T1.404, T1.105.03, Telcordia GR-253, GR-499, ITU-T G.823, G.824, G.825, G.958

This extremely fast measurement tests the device under test for conformance to the standard tolerance mask limits for maximum tolerable jitter.

Jitter frequencies	up to 10 fixed frequencies corresponding to standard tolerance mask
Detection criteria	TSE (bit error), code error, B2, B3, REI, RDI
Error threshold	0 to 999,999 errors
Settling time	0.1 to 99.9 s

The editable frequency/amplitude values are set sequentially and the test pattern monitored for the permitted bit error count by the receiver.

The result of each measurement is shown in a table as the status message "OK" or "FAILED".

*Automatic determination of maximum tolerable Jitter (MTJ)*

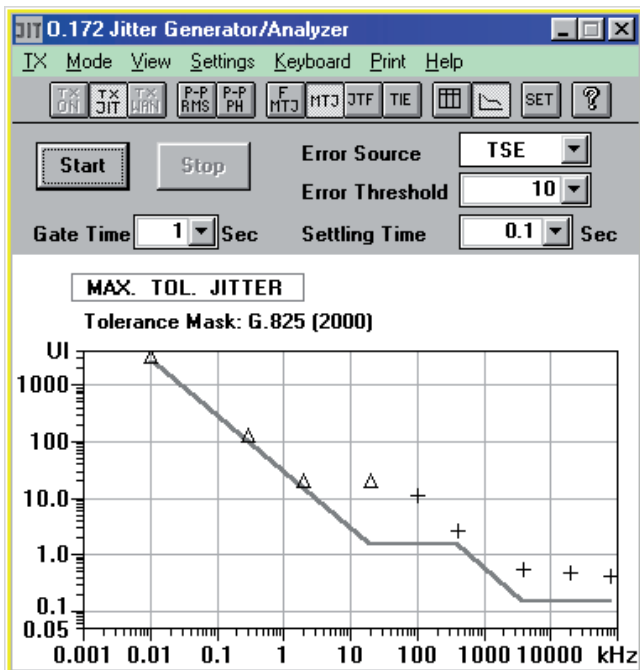

Maximum tolerable jitter testing

ANSI T1.403, T1.404, T1.105.03, Telcordia GR-253, GR-499, ITU-T G.823, G.824, G.825, G.958

The ANT-10G automatically determines the maximum jitter amplitude tolerated by the device under test at each jitter frequency.

Jitter frequencies	20 freely selectable frequencies
Detection criteria	TSE (bit error), code error, B2, B3, REI, RDI
Error threshold	0 to 999999 errors
Settling time	0.1 to 99.9 s
Gating time	1 to 999 s

The maximum permissible jitter amplitude is determined precisely and quickly using a successive method.

The ANT-10G determines the exact limit value.

The method is derived from long experience in the performance of jitter tolerance tests and is recognized by leading systems manufacturers.

The frequency/amplitude result pairs can be displayed in tabular and graphical form.

The graphical display includes the standard tolerance masks. The distance of the measurement points from the tolerance masks indicates the degree to which the device under test meets the requirements of the standard.

Tolerance mask violations during the measurement are indicated in the numerical table.

*Freely programmable tolerance masks*

The existing tolerance masks for the ANT-10G can be altered as required to suit requirements that do not conform to specific standards. The new values selected for jitter frequency and amplitude are stored when the application is saved.

*Automatic pointer sequences for analyzing combined jitter (available with CATS test sequencer option)*

Among other things, T1.105.03 defines various pointer sequence scenarios for testing combined jitter (mapping and pointer jitter) at network elements.

These sequences are normally selected manually and the jitter measured. ANT-10G allows simple automation of these sequences. The entire sequence is started and the maximum pointer jitter determined with a single key press. This saves considerable time spent in setting up the test and executing the measurement.

*Automatic limit testing of maximum tolerable wander (MTW)*

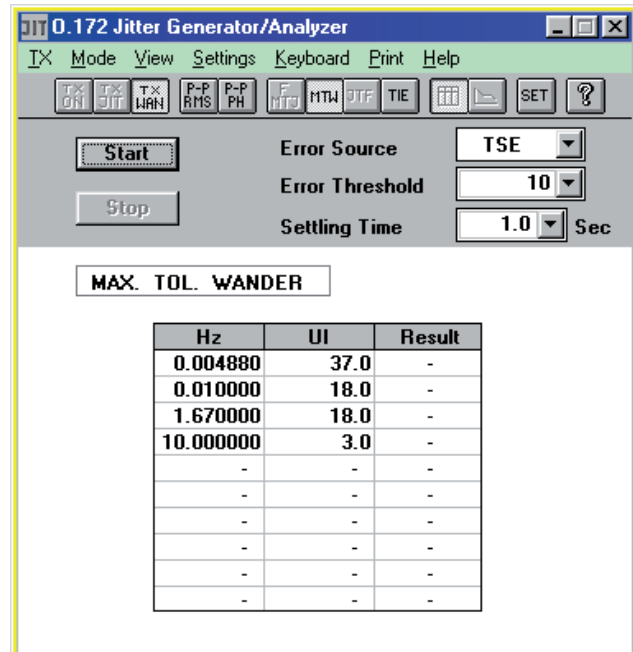

Maximum tolerable wander result display

ITU-T G.823, G.824

The ANT-10G tests the device under test for conformance to the standard tolerance mask limits for maximum tolerable wander.

Measurement points	up to 10 frequency/amplitude values
Detection criteria	TSE (bit error), alarms
Frequency range	10 $\mu$ Hz to 10 Hz, step 1 $\mu$ Hz
Amplitude range	0.1 to 200 000 UI, step: 0.1 UI

The result of each measurement is shown in a table with an "OK" or "FAILED" message.

## ATM options

With its ATM options, ANT family enables commissioning tests on newly installed ATM links. The major error and delay-related performance parameters can be quickly and reliably verified in this manner. Using the flexible cell generator, policing functions can be easily checked. Bit error analyses and alarm flow diagnostics allow a fast assessment of whether links are working properly.

ATM cells can be generated for all bit rates up to STM-1/OC-3 (for option BN 3035/90.63).

ATM cells can be generated for all bit rates up to STM-4c/OC-12c (for option BN 3060/90.63).

### Add ATM up to 155M (for ANT-20 only)

**BN 3035/90.63**

#### General

##### Adjustable test channel from 0 to 150 Mb/s

In ATM network elements, user channels are monitored with the UPC (usage parameter control). The sensors of the control instance can be quickly checked if the bandwidth of a test channel exceeds the set threshold in the network element. For all measurements, the test channel in the ANT-10G is set on-line. Settings are made directly with a control which shows the bandwidth in Mb/s, Cells/s or %. This makes it easy to simulate CBR (Constant Bit Rate) sources. For each interface, the load setting has a range from 0.01% to 100%. This corresponds to the load conditions which can occur in the real world.

##### Load profiles

A test channel can be generated with typical load profiles in order to stress network elements or simulate source profiles. In burst mode, for example, the burst load, burst length and burst period parameters can be used to simulate a video signal whose key figures correspond to a real-life signal.

##### Background load generator

To make a real-time measurement under loaded conditions, additional background load can be simulated to supplement the test channel (foreground traffic). The ATM channels are defined using an editor. The user specifies the repetition rate of the load cell and a sequence of empty cells. Load channels can be transmitted continuously as a sequence. The load generator can also be used separately with the test channel switched off. In this case, the channels and profiles can be user-specified.

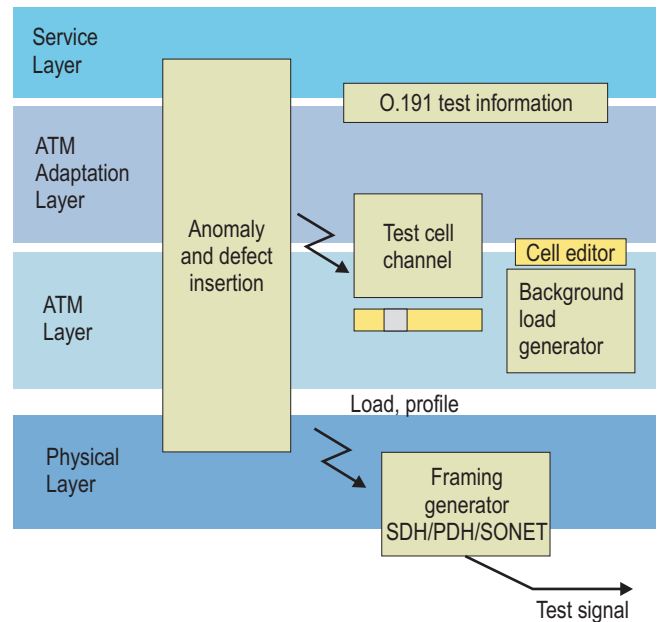

#### Determining cell delay variation

The ANT family includes very powerful tools for measuring delay parameters. Once a precise measurement has been made, subsequent measurements usually require only a low-resolution display to allow rapid pass/fail assessment. Delay values are displayed by the ATM Traffic Analyzer as a histogram with a minimum class width equal to 160 ns (maximum 335 ms). As a result, delay fluctuations are shown graphically with the same resolution. An adjustable offset can be used to maintain measurement accuracy even if the delay values are high, e.g. over inter-national links.

#### F4/F5 OAM alarm flow

In accordance with I.610 and the ATM forum standard, the status of ATM paths and channels is transmitted in the OAM cell stream (fault management). The ANT family generates the alarms VP-AIS, VC-AIS or VP-RDI, VC-RDI for the foreground channel. The receiver simultaneously detects alarms and error messages in the channel and path.

#### The ATM module comprises

- Generation and analysis of ATM cell streams
- ATM layer cell transfer performance as per ITU-T I.356, O.191
- AAL-1 segmentation/reassembly for circuit emulation
- STM-1/STS-3c with C4 ATM mapping, ITU-T G.707, ANSI T1.105/107
- F4/F5 fault management OAM flow for AIS and RDI as per ITU-T I.610, ATM forum UNI 3.1

#### Generator

Signal structure (TC sub-layer) contiguous concatenation to T1.646, I.432 and af-phy-0046.000

Bit rates of the framed cell streams 155520 kb/s  
Cell scrambler X43+1 (ITU-T) can be switched on and off

**Test cell channel**

Adjustable from	0 to 149760 kb/s
Header setting	editor
Load setting in	Mb/s, Cells/s, %

**Test cells, payload pattern**

AAL-0, Pseudo-Random Bit Sequences (PRBS)	$2^{11}-1, 2^{15}-1, 2^{23}-1$
AAL-1, Pseudo-Random Bit Sequences (PRBS)	$2^{11}-1, 2^{15}-1, 2^{23}-1$
Programmable word, length	16 bits
Test pattern for ATM performance analysis, with sequence number	3 bytes
Time stamp	4 bytes
Error correction	CRC-16

**Load profiles**

Equidistant, setting range	1 to 10000 cell times
Constant bit rate (CBR), setting range	0.01% to 100%

**Variable bit rate (VBR), settings**

Peak cell rate	1% to 100%
Mean cell rate	1% to 100%
Burst size	1 to 1023 cell times
Burst period	2 to 32767 cell times

**Error insertion**

Physical layer as with ANT-10G basic instrument ATM layer, AAL:

Correctable and non-correctable header errors

AAL-0, cell payload bit errors

AAL-1, sequence number errors

AAL-1, SAR-PDU bit errors

AAL-1 SNP, CRC errors

AAL-1 SNP, parity errors

Resolution single errors, error ratio, n errors in m cells

**Alarm generation**

Loss of Cell Delineation LCD

**ATM layer (for selected test cell channel):**

OAM F4/F5 fault flow VP AIS, VP RDI, VP AIS+VC AIS, VC AIS, VC RDI, VP RDI+VC RDI

**Background load generator**

For programming user-defined cell sequences. The sequences can be transmitted at a selectable repetition rate.

Editor	200 ATM channels
Header	user-selectable
Payload	1 filler byte, user-selectable

**Circuit emulation (for selected test cell channel)**

Generation of an asynchronous channel 1544, 2048, 6312, 8448, 34...368, 44736 kb/s, 2048 kb/s with PCM30 frame structure

ATM channel segmentation AAL-1, ITU-T I.363

**Receiver**

Bit rates of framed cell streams 155520 kb/s

Cell scrambler X43+1 (ITU-T) can be switched on and off

**Error measurement (anomalies), statistics**

Detection of the following error types:

Correctable and non-correctable header errors

AAL-0, cell payload bit errors

AAL-1, sequence number errors

AAL-1, SAR-PDU bit errors

AAL-1 SNP, CRC errors

AAL-1 SNP, parity errors

**ATM performance analysis**

Cell error ratio

Cell loss ratio

Cell mis-insertion rate

Mean cell transfer delay

2-point cell delay variation

measured between minimum and maximum cell transfer delay values

Cell transfer delay histogram

Number of classes	128
Minimum class width	160 ns
Maximum class width	335 ms
Settable offset	0 to 167 ms
Offset step width	2.5 $\mu$ s

**Alarm detection (defects) (ISM, OoS)**

Loss of Cell Delineation LCD

ATM layer (for selected test cell channel):

OAM F4/F5 fault flow VP AIS, VP RDI, VC AIS, VC RDI

**Traffic channel analysis**

Time chart simultaneously for:

All traffic cells

Average cell rate of any selected cell channel

Peak cell rate of any selected cell channel

Display in Mb/s, Cells/s, %

**Channel utilization histogram**

All assigned cells

One selected cell channel (user cells)

Cell distribution in traffic channel with classification by:

User cells

F5 OAM flow

F4 OAM flow

User cells with CLP=1

**Circuit reassembly (for selected test cell channel)**

Reassembly AAL-1, ITU-T I.363

Error measurement on an asynchronous channel 1544, 2048, 6312, 8448, 34368, 44736 kb/s, 2048 kb/s with PCM30 frame structure

**ATM SDH mappings**

The ATM mappings provide frame structures for interfaces conforming to ITU-T G.804/832/707.

Corresponding physical layer measurement functions are offered by the mapping options for the interfaces. These include error and alarm insertion, error measurement and alarm detection.

E4 (140 Mb/s) ATM mapping, Bit rate 139264 kb/s

E3 (34 Mb/s) ATM mapping, Bit rate 34368 kb/s

E1 (2 Mb/s) ATM mapping, Bit rate 2048 kb/s

STM-1/VC3 ATM mapping, Bit rate 155520 kb/s



**ATMSONET mappings**

The ATM mappings provide frame structures for interfaces conforming to ANSIT1.105/107.

Corresponding physical layer measurement functions are offered by the mapping options for the interfaces. These include error and alarm insertion, error measurement and alarm detection.

**STS-1/STS-3 ATM mapping**

Bit rate, STS-1	51840 kb/s
DS3 (45 Mb/s) ATM mapping and STS-1 DS3 ATM mapping	

**PLCP-based mapping  
HEC-based mapping**

Bit rate	44736 kb/s
DS1 (1.5 Mb/s) ATM mapping, Bit rate	1544 kb/s

**Add ATM up to 622M (for all ANTs)**

**BN 3060/90.63**

Only in conjunction with an optical interface of at least up to STM4/OC-12

The specifications and functionalities described in the option BN 3035/90.63 are also included herein

**Generator**

Bit rates of the framed cell streams	622080 kb/s
--------------------------------------	-------------

**Load profiles (different from BN 3035/90.63)**

Equidistant, setting range	4 to 40000 cell times +1
Constant bit rate (CBR), setting range	0.01 to 25%
Variable bit rate (VBR), settings	

Peak cell rate	1 to 25%
Mean cell rate	1 to 25%
Burst size	4 to 4092 cell times
Burst period	8 to 131068 cell times

**Background load generator (different from BN 3035/90.63)**

1 channel can be switched ON/OFF

Residual bandwidth	up to 599040 kb/s
--------------------	-------------------

Header is freely definable

**Receiver**

Bit rates of framed cell streams	622080 kb/s
----------------------------------	-------------

**Test automation and remote operation options**

**GPIB (PCMCIA) remote control interface**

BN 3035/92.10

Remote control of instrument functions using SCPI command structure. A GPIB adapter card for the ANT family PCMCIA interface is supplied with this option

Interface	GPIB
-----------	------

**Test sequencer CATS**

**BN 3035/95.90**

The test sequencer is the ideal tool for rapid, simple adaptation and automatic performance of complete test sequences on the ANT family (CATS = Computer Aided Test Sequence). This saves time where repetitive tests are required in the production, installation and monitoring of SDH, SONET and ATM network elements. The comprehensive test case library includes solutions for various applications, such as BERTs, alarm sensor tests, jitter, offset and pointer tests and monitoring ATM Quality of Service (QoS) parameters.

Once created, test sequences are started with a single mouse click. A report in ASCII format for documentation purposes is compiled during the measurement. All test cases are pre-defined and ready to run. They can also be easily customized.

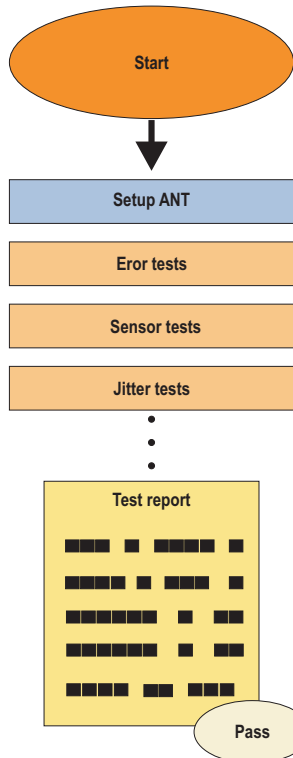

Automatic test sequences with the ANT-10G

### *Simplified test automation*

Particularly in design verification, R&D, regression testing and conformance testing it is required to deal with a number of test sets from different vendors. In many cases it is also necessary to include the "System under Test" in an automated setup. The CATS Professional package is designed to simplify integration of the ANT family into these test environments. Existing CATS test routines can be made available so they run not only in a self-contained manner but also as ready-made plug-ins for the customer's own test solution.

For more information see the data sheet „Test Automation and Remote Control“.

### **Remote operation**

#### *BN3035/95.30*

This option allows operation of the ANT family from a Windows™ PC. The complete ANT family user interface is transferred to the PC screen via modem or LAN link. This means that all the functions of the instrument can be used from any remote location. The results are simply transferred to the controlling PC for further processing. Applications include troubleshooting networks or centralized operation of test instrumentation and devices in the production and system test environment.

Provides remote operation software for remote GUI via the included Ethernet Interface, PCMCIA modem or external modem (at the V.24 interface).

## Other options

### **Optical power splitter (90%/10%)**

#### *BN3035/90.49*

The optical power splitter is built into the ANT family mainframe. Three optical test adapters are required to operate it, please indicate your choice.

The optical power splitter provides an optical monitor point. The input signal is passed through to the output transparently.

Light energy forwarded	approx. 90% (-0.45 dB)
Light energy coupled out	approx. 10% (-10 dB)

The optical power splitter operates in the following ranges:

Wavelengths	1260 to 1360 nm and 1500 to 1600 nm
-------------	-------------------------------------

### **Calibration report**

#### *BN3060/94.01*

Calibration is carried out in accordance with a quality management system certified to ISO 9001.

Recommended confirmation interval 24 months.

## Ordering information

Order No.	Name	Possible options	
<b>ANT-20/ANT-20se packages</b>			
Each package includes: SDH/SONET all mappings, OH byte capture/sequencer, TCM, APS, PDH/DSn with Mux/Demux, D&I, Through mode , Remote Control via V.24/RS-232, TCP/IP, LabWindows driver, optical connectors			
BN 3035/13	ANT-20 up to 155M el. P#13 • ANT-20 SDH STM-0/1, OC-1/3 • Electrical Interfaces: 1.5 to 155 Mb	• Add jitter/wander up to 155M • Add ATM up to 155M	BN 3035/91.29 BN 3035/90.63
BN 3035/14	ANT-20 up to 155M el. P#14 • ANT-20 SONET OC-1/3, STM-0/1 • Electrical Interfaces: 1.5 to 155 Mb	• Add jitter/wander up to 155M • Add ATM up to 155M	BN 3035/91.29 BN 3035/90.63
BN 3035/ 08	ANT-20 up to 155M P#1 • ANT-20 SDH STM-0/1 • Electrical Interfaces: 1.5 to 155 Mb • Optical Interfaces: 52 to 155 Mb — 1310/1550 nm	• Add jitter/wander up to 155M • Add ATM up to 155M	BN 3035/91.29 BN 3035/90.63
BN 3035/15	ANT-20 up to 155M P#15 • ANT-20 SONET OC-1/3, STM-0/1 • Electrical Interfaces: 1.5 to 155 Mb • Optical Interfaces: 52 to 155 Mb — 1310/1550 nm	• Add jitter/wander up to 155M • Add ATM up to 155M	BN 3035/91.29 BN 3035/90.63
BN 3035/ 09	ANT-20 up to 622M P#2 • ANT-20 SDH STM-0/1/4 • Electrical Interfaces: 1.5 to 155 Mb • Optical Interfaces: 52 to 622 Mb — 1310/1550 nm	• Add jitter/wander up to 155M • Add jitter/wander up to 622M • Add ATM up to 622M	BN 3035/91.29 BN 3035/91.31 BN 3060/90.63
BN 3060/ 55	ANT-20 up to 622M P#5 • ANT-20se SDH STM-0/1/4 • Electrical Interfaces: 1.5 to 155 Mb • Optical Interfaces: 52 to 622 Mb — 1310/1550 nm	• Add jitter/wander up to 155M • Add jitter/wander up to 622M • Add ATM up to 622M	BN 3035/91.29 BN 3035/91.31 BN 3060/90.63
BN 3060/ 56	ANT-20 up to 622M P#6 • ANT-20se SONET OC-1/3/12 • Electrical Interfaces: 1.5 to 155 Mb • Optical Interfaces: 52 to 622 Mb — 1310/1550 nm	• Add jitter/wander up to 155M • Add jitter/wander up to 622M • Add ATM up to 622M	BN 3035/91.29 BN 3035/91.31 BN 3060/90.63
BN 3060/ 57	ANT-20 up to 2.5G P#7 • ANT-20se SDH STM-0/1/4/16 • Electrical Interfaces: 1.5 to 155 Mb • Optical Interfaces: 52 to 2.5G — 1310/1550 nm	• Add jitter/wander up to 155M • Add jitter/wander up to 622M • Add jitter/wander up to 2.5G • Add ATM up to 622M	BN 3035/91.29 BN 3035/91.31 BN 3060/91.32 BN 3060/90.63
BN 3060/ 58	ANT-20 up to 2.5G P#8 • ANT-20se SONET OC-1/3/12/48 • Electrical Interfaces: 1.5 to 155 Mb • Optical Interfaces: 52 to 2.5G — 1310/1550 nm	• Add jitter/wander up to 155M • Add jitter/wander up to 622M • Add jitter/wander up to 2.5G • Add ATM up to 622M	BN 3035/91.29 BN 3035/91.31 BN 3060/91.32 BN 3060/90.63

### Add Jitter/Wander for ANT-20 and ANT-20se packages

Each package includes: Jitter generation and analysis, automatic measurements: MTJ, F-MTJ, JTF, MTIE-TDEV offline analysis

BN 3035/ 91.29	Add Jitter /Wander up to 155M	For ANT-20 and ANT-20se
BN 3035/ 91.31	Add Jitter /Wander up to 622M	For ANT-20 and ANT-20se
BN 3060/ 91.32	Add Jitter /Wander up to 2.5G	For ANT-20se only

### ANT-10G packages

Each package includes: SDH/SONET all mappings, OH byte capture/sequencer, TCM, APS, PDH/DSn with Mux/Demux, D&I, Through mode , Remote Control via V.24/RS-232, TCP/IP, LabWindows driver, optical connectors

Order No.	Name	Possible options	
BN 3060/ 71	ANT-10G 1550 P#1 • ANT-10G SDH STM-1/4/16 and 10G • Electrical Interfaces: 1.5 to 155 Mb • Optical Interfaces: 52M to 2.5G — 1310/1550 nm 10G — 1550 nm	• Add ATM up to 622M • Add 10G electrical Interfaces *	BN 3060/90.63 BN 3060/91.48
BN 3060/ 72	ANT-10G 1550 P#2 • ANT-10G SDH STM-64 • Electrical Interfaces: 1.5 to 155 Mb • Optical Interfaces: 10G — 1550 nm	• Jitter/Wander 10G • Add ATM up to 155M • Add 10G electrical Interfaces *	BN 3035/90.63 BN 3060/91.48
BN 3060/ 73	ANT-10G 1550 P#3 • ANT-10G SDH STM-1/ and 64 • Electrical Interfaces: 1.5 to 155 Mb • Optical Interfaces: 52 to 622 Mb — 1310/1550 nm 10G — 1550 nm • Jitter/Wander all built-in rates	• Add ATM up to 622M • Add 10G electrical Interfaces*	BN 3060/90.63 BN 3060/91.48
BN 3060/ 74	ANT-10G 1550 P#4 • ANT-10G SDH STM-1/4/16 and 64 • Electrical Interfaces: 1.5 to 155Mb • Optical Interfaces: 52 to 2.5G — 1310/1550 nm 10G — 1550 nm • Jitter 10G	• Add ATM up to 622M • Add 10G electrical Interfaces *	BN 3060/90.63 BN 3060/91.48
BN 3060/ 81	ANT-10G Dual P#11 • ANT-10G SDH STM-1/4/16 and 10G • Electrical Interfaces: 1.5 to 155Mb • Optical Interfaces: 52M to 2.5G — 1310/1550nm 10G – 1310/1550nm	• Add ATM up to 622M • Add 10G electrical Interfaces *	BN 3060/90.63 BN 3060/91.54
BN 3060/ 82	ANT-10G Dual P#12 • ANT-10G SDH STM-64 • Electrical Interfaces: 1.5 to 155Mb • Optical Interfaces: 10G – 1310/1550nm • Jitter/Wander 10G	• Add ATM up to 155M • Add 10G electrical Interfaces *	BN 3035/90.63 BN 3060/91.54
BN 3060/ 83	ANT-10G Dual P#13 • ANT-10G SDH STM-1/4 and 64 • Electrical Interfaces: 1.5 to 155Mb • Optical Interfaces: 52 to 622Mb — 1310/1550nm 10G – 1310/1550nm • Jitter/Wander all built-in rates	• Add ATM up to 622M • Add 10G electrical Interfaces *	BN 3060/90.63 BN 3060/91.54
BN 3060/ 84	ANT-10G Dual P#14 • ANT-10G SDH STM-1/4/16 and 64 • Electrical Interfaces: 1.5 to 155Mb • Optical Interfaces: 52 to 2.5G — 1310/1550nm 10G – 1310/1550nm • Jitter 10G	• Add ATM up to 622M • Add 10G electrical Interfaces *	BN 3060/90.63 BN 3060/91.54
Add ATM Packages			
Each package includes: AAL-0, AAL-1, variable traffic loads, Circuit emulation, ATM performance analysis, traffic channel statistics			
BN 3035/90.63	Add ATM up to 155M • Mappings: SDH: E1, E3, E4, VC3 • Mappings: SONET: DS1, DS3, STS-1	For ANT-20 only	
BN 3060/90.63	Add ATM up to 622M • Mappings: SDH: E1, E3, E4, VC3, VC4c • Mappings: SONET: DS1, DS3, STS-1, OC-12c	For all ANTs	

Order No.	Name	Possible options
Add Accessories to all ANTs		
BN 3035/95.95	CATS Professional	Test sequencer for ANTs
BN 3035/92.10	Remote Control interface GPIB	
BN 3035/95.30	Remote Operation (PcAnywhere)	
BN 3035/90.49	Optical Power splitter ANTs (90%/10%)	Includes three optical adapters -- please select
BN 3060/94.01	Calibration report ANTs	Calibration is carried out in accordance with quality management system certified to ISO 9001
BN 960/00.08	Hard case ANT-20	
BN 3035/92.02	Soft case ANT-20	
BN 3035/92.03	Hard case ANT-20se/ANT-10G	
BN 3035/92.04	External keyboard (UK/US)	
BN 3903/63	Decoupler (-20 dB, 1.6/5.6 jack plug)	
BN 822/01	TKD-1 probe, 48 to 8500 kb/s	

\* This option must be ordered with the mainframe as a subsequent upgrade is not possible

### Optical connectors

One type of optical connector must be selected from BN 2060/00.xy for every optical interface as listed below.

### Measuring adapter

Order No.	Name
BN 2060/00.51	FC, FC-PC, FC-APC
BN 2060/00.58	SC, SC-PC, SC-APC
BN 2060/00.32	ST type (AT&T)
BN 2060/00.50	DIN 47256
BN 2060/00.53	E 2000 (Diamond)
BN 2060/00.59	LC, F-3000 (PC-APC)

### Optical attenuators

Order No.	Name		
BN 2060/00.51	LC, F-3000 (PC-APC)FC-PC,	10 dB	1310/1550 nm
BN 2239/90.38	SC	10 dB	1310/1550 nm

JDSU offers a wide range of optical power meters, sources and attenuators.

Contact your local sales representative for details.



## Related products



### Multiple Application Platform (MAP)

With over 20 unique modules, MAP enables users to manipulate and control optical transmission signals (independent of rate or format) and enables testing of transmission quality as a function of parameters such as Average Power, OSNR and Polarization state. Optical switches and optical splitter modules may be added to enable automation interfaces for multiple devices and/or multiple signal sources.

The modular platform is available in 3 or 8 slot chassis with GPIB or RS-232 interfaces. ActiveX and LabView drivers are also provided. Rack mount kits and a reverse mount system enable clean factory test integration and rear fiber exit when needed.

2×2: optical switch (cross)

OA: optical amplifier

OPM: optical power meter

VOA: variable optical attenuator

1×N: 1:N switch

TBF: tunable band pass filter

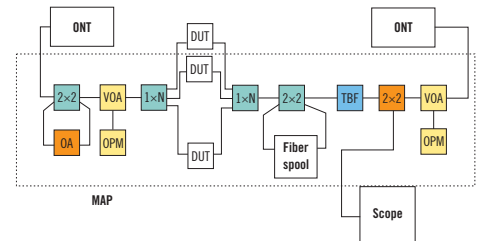

### OLC-65 Optical Level Controller

The OLC-65 contains both attenuator and power meter function making test set-up simple and eliminating the need to connect several instruments, cables and couplers. See OLC-65 data sheet for details.



### GPIB-RS232 Converter GPIB-232CV-A

It is recommended that the National Instruments GPIB/RS-232 Converter be used for controlling the ONT-50 via GPIB. Ordering is country-specific.

Go to [www.ni.com](http://www.ni.com) for further details.



### Handheld Fiber Inspection Microscope OIM-400

Many light transmission problems occur as a result of improper fiber connectors. The Fiber Microscope reflects details of scratches and any contamination of connector end surfaces. The light weight microscope is equipped with universal push-pull adapter.

Magnification 400×

Power supply 3 "AAA" batteries

OIM-400 BN WO-FM-C400



### TSR-37 Rubidium Timing Source Reference

DA 3700/00

The TSR-37 is a powerful reference source to quickly measure and test the synchronization quality of PDH/SDH/SONET digital networks. MTIE and TDEV measurements for up to 1000 seconds can be easily performed without a GPS reference. Coupled with the optional GPS-FC, the range of observation time can be largely extended to meet specific requirements.

Provides the reference clock for wander analysis.

PDH/SDH/SONET Wander measurement source

**ONT-50**

Portable solution for testing of design and conformance of Next Generation transport networks. It has four slots that can be equipped with any combination of modules for PDH/DSn, SDH/SONET up to 10 Gb/s, OTN up to 10.7 Gb/s, Jitter/Wander, NewSDH/NewSONET, PoS, Ethernet, Q-factor, and OSA testing. Multiple users can run multiple applications simultaneously and independently. Supports remote operation and automation. High resolution 12" colored touchscreen. See ONT-50 data sheet for details.

**ONT-506**

Portable desktop solution for testing of design and conformance of Next Generation transport networks. It has six slots that can be equipped with any combination of modules for PDH/DSn, SDH/SONET up to 40 Gb/s, Multichannel, OTN up to 43 Gb/s, Jitter/Wander up to 43 Gb/s, NewSDH/NewSONET, PoS, Ethernet up to 10GE, and OSA testing. Multiple users can run multiple applications simultaneously and independently. Supports remote operation and automation. Linux operation system. High resolution 15" colored touchscreen. See ONT-506/512 data sheet for details.

**ONT-512**

Rack-mount solution for testing of design and conformance of Next Generation transport networks. Same applications as ONT-506 with 12 slots. Easy integration into automated environments with Linux operating system and Tcl/Tk and LabWindows libraries. Built-in controller. See ONT-506/512 data sheet for details.

All statements, technical information and recommendations related to the products herein are based upon information believed to be reliable or accurate. However, the accuracy or completeness thereof is not guaranteed, and no responsibility is assumed for any inaccuracies. The user assumes all risks and liability whatsoever in connection with the use of a product or its applications. JDSU reserves the right to change at any time without notice the design, specifications, function, fit or form of its products described herein, including withdrawal at any time of a product offered for sale herein. JDSU makes no representations that the products herein are free from any intellectual property claims of others. Please contact JDSU for more information. JDSU and the JDSU logo are trademarks of JDS Uniphase Corporation. Other trademarks are the property of their respective holders.  
© 2006 JDS Uniphase Corporation. All rights reserved. 10143236 002 0707 ANT.DS.OPT.TM.AE

**Test & Measurement Regional Sales**

<b>NORTH AMERICA</b> TEL: 1 866 228 3762 FAX: +1 301 353 9216	<b>LATIN AMERICA</b> TEL:+55 11 5503 3800 FAX:+55 11 5505 1598	<b>ASIA PACIFIC</b> TEL:+852 2892 0990 FAX:+852 2892 0770	<b>EMEA</b> TEL:+49 7121 86 2222 FAX:+49 7121 86 1222	<b>WEBSITE:www.jdsu.com</b>
---	--	---	---	-----------------------------