

User's and Service Guide

Agilent Technologies 11644A R, Q, U, V, and W Waveguide Calibration Kits

This manual applies to 11644A series calibration kits with
serial number prefix 3032A.



Agilent Part Number: 11644-90369

Printed in USA

Print Date: January 2002

Supersedes: April 1997

Warranty

This product is warranted against defects in material and workmanship for a period of one year from date of shipment. During the warranty period, Agilent Technologies will, at its option, either repair or replace products which prove to be defective.

For warranty service or repair, this product must be returned to a service facility designated by Agilent. Buyer shall prepay shipping charges to Agilent and Agilent shall pay shipping charges to return the product to Buyer. However, Buyer shall pay all shipping charges, duties, and taxes for products returned to Agilent from another country.

Agilent Technologies warrants that its software and firmware designated by Agilent for use with an instrument will execute its programming instructions when properly installed on that instrument. Agilent Technologies does not warrant that the operation of the instrument, or software, or firmware will be uninterrupted or error-free.

Limitation of Warranty

The foregoing warranty shall not apply to defects resulting from improper or inadequate maintenance by Buyer, Buyer-supplied software or interfacing, unauthorized modification or misuse, operation outside of the environmental specifications for the product, or improper site preparation or maintenance.

NO OTHER WARRANTY IS EXPRESSED OR IMPLIED. AGILENT TECHNOLOGIES SPECIFICALLY DISCLAIMS THE IMPLIED WARRANTIES OF MERCHANTABILITY AND FITNESS FOR A PARTICULAR PURPOSE.

Exclusive Remedies

THE REMEDIES PROVIDED HEREIN ARE BUYER'S SOLE AND EXCLUSIVE REMEDIES. AGILENT TECHNOLOGIES SHALL NOT BE LIABLE FOR ANY DIRECT, INDIRECT, SPECIAL, INCIDENTAL, OR CONSEQUENTIAL DAMAGES, WHETHER BASED ON CONTRACT, TORT, OR ANY OTHER LEGAL THEORY.

Assistance

Product maintenance agreements and other customer assistance agreements are available for Agilent products.

For any assistance, contact Agilent Technologies. Refer to [page 6-4](#) for a list of Agilent contacts.

Contents

1. General Information

Calibration Kit Overview	1-2
Kit Contents	1-2
Compatible Network Analyzers	1-2
Equipment Required but Not Supplied	1-3
Calibration Kit History	1-3
11644A Series Kits with Serial Prefix 3012A	1-3
Incoming Inspection	1-3
Recording the Device Serial Numbers	1-4
Preventive Maintenance	1-5

2. Specifications

Environmental Requirements	2-2
Temperature—What to Watch Out For	2-2
Mechanical Characteristics	2-3
Electrical Characteristics and Specifications	2-3
Residual Errors after Calibration	2-3
Certification	2-3

3. User Information

Calibration Devices and Their Use	3-2
Short	3-2
Standard Section	3-2
Termination	3-2
¼ Wavelength Shim	3-2
Waveguide Straight Section (verification device)	3-2
Waveguide Straight Section (port 1 and 2)	3-2
Measurement Applications	3-3
Isolation	3-3
Line	3-3
Load	3-4
Offset Load	3-4
Offset Short	3-5
Reflect	3-5
Short	3-5
Thru	3-6
¼ Wavelength Load	3-6
¼ Wavelength Short	3-6
Changing the ¼ Wavelength Shim Calibration Definition	3-7

4. Use, Maintenance, and Care of the Devices

Electrostatic Discharge	4-2
Visual Inspection	4-2
Cleaning the Mating Plane Surfaces	4-3
Connections	4-4
Waveguide Devices	4-4
Precision Flanges	4-4
Aligning Two Precision Flanges	4-5

Aligning a Precision and a Non-Precision Flange	4-6
Tightening a Flange Connection	4-7
Inspecting a Flange Connection	4-7
Handling and Storage	4-8
5. Performance Verification	
Introduction	5-2
How Agilent Verifies the Devices in Your Kit	5-2
Recertification	5-3
How Often to Recertify	5-3
Where to Send a Kit for Recertification	5-3
Performance Test	5-4
Termination Return Loss Measurement	5-4
In Case of Failure	5-5
6. Troubleshooting	
Troubleshooting Process	6-2
Returning a Kit or Device to Agilent	6-4
Where to Look for More Information	6-4
Contacting Agilent	6-4
7. Replaceable Parts	
Introduction	7-3
A. Standard Definitions	
Standard Class Assignments	A-2
Blank Forms	A-5
Nominal Standard Definitions	A-7
Setting the System Impedance	A-7
Version Changes	A-7
Blank Forms	A-18

1 General Information

Calibration Kit Overview

This waveguide calibration kit is used to calibrate network analyzer systems (such as the Agilent 8510 or 872x series). With the calibration data properly loaded in the network analyzer and a measurement calibration completed, systematic errors are minimized.

NOTE TRL (thru-reflect-line) calibrations require Agilent 8510 operating system firmware revision B.05.12 or greater.

Kit Contents

Refer to [Chapter 7, “Replaceable Parts,”](#) for a complete list of kit contents and their associated part numbers.

The basic 11644A calibration kit includes the following items:

- user’s and service guide
- short, shim, termination, waveguide straight, and standard sections
- data disks that contain the calibration definitions of the devices in the calibration kit

The standards in this calibration kit allow you to perform simple 1- or 2-Port and TRM (thru-reflect-match) calibrations.

For your convenience, two different lengths of screws are provided in this kit. While you can use the long screws for any connection, the shorter screws provide a faster connection for two-flange connections.

NOTE A backup copy of each data disk should be made immediately upon receipt of the waveguide calibration kit. Refer to your analyzer user’s guide for instructions on duplicating a disk.

Compatible Network Analyzers

The 11644A calibration kits are intended to be used with the following Agilent network analyzers:

- 8510 series
- 872x series
- PNA microwave series

If this calibration kit is used with other network analyzers, the calibration definitions must be manually entered into the network analyzer. Refer to your network analyzer user’s guide for instructions or embedded help for instructions.

Equipment Required but Not Supplied

Cleaning supplies and various electrostatic discharge (ESD) protection devices are not supplied with the calibration kit but are required to ensure successful operation of the kit. Refer to [Table 7-6 on page 7-14](#) for their associated part numbers.

Calibration Kit History

This manual applies to any Agilent 11644A series (R, Q, U, V, or W) waveguide calibration kits whose serial number prefix is listed on the title page. If your calibration kit has a different serial number prefix, refer to the next section for information on how this manual applies.

11644A Series Kits with Serial Prefix 3012A

These calibration kits did not have the calibration definitions disk to support the Agilent 8510C network analyzer. The part numbers provided in this manual are the recommended replacement parts for these kits. The devices in these kits should meet the specifications published in this manual.

Incoming Inspection

Refer to [“Kit Contents” on page 1-2](#) to verify a complete shipment. Use [Table 1-1](#) in this chapter to record the serial numbers of all serialized devices in your kit.

Verify that the case and its contents are not damaged. The foam-lined storage case provides protection during shipping. If the case or any device appears damaged, or if the shipment is incomplete, refer to [“Contacting Agilent” on page 6-4](#). Agilent will arrange for repair or replacement of incomplete or damaged shipments without waiting for a settlement from the transportation company. Refer to [“Returning a Kit or Device to Agilent” on page 6-4](#).

Recording the Device Serial Numbers

In addition to the kit serial number, the devices in the kit are individually serialized (serial numbers are labeled onto the body of each device). Record these serial numbers in the appropriate table. Recording the serial numbers will prevent confusing the devices in this kit with similar devices from other kits.

Table 1-1 V and W Band Serial Number Record

Device	Serial Number
Frequency band	_____
Calibration kit	_____
Fixed load	_____
Straight section (5 cm)	_____
Straight section (5 cm)	_____
Straight section (5 cm)	_____
Shim	_____
Short	_____

Table 1-2 R, Q, and U Band Serial Number Record

Device	Serial Number
Frequency band	_____
Calibration kit	_____
Straight section (5 cm)	_____
Straight section (5 cm)	_____
Standard section (10 cm)	_____
Waveguide straight	_____
Shim	_____
Short	_____

Preventive Maintenance

The best techniques for maintaining the integrity of the devices in the kit include:

- routine visual inspection
- routine cleaning
- proper gaging
- proper connection techniques

All of these are described in [Chapter 4](#). Failure to detect and remove dirt or metallic particles on a mating plane surface can degrade repeatability and accuracy and can damage any device mated to it. Improper connections resulting from poor connection techniques, can also damage these devices.

2 Specifications

Environmental Requirements

Table 2-1 Environmental Requirements

Parameter	Limits
Temperature	
Operating ^a	+20 °C to +26 °C
Storage	-40 °C to +75 °C
Error-corrected range ^b	±1 °C of measurement calibration temperature
Altitude	
Operating	< 4,500 meters (≈15,000 feet)
Storage	< 15,000 meters (≈50,000 feet)
Relative humidity	Always non-condensing
Operating	0 to 80% (26 °C maximum dry bulb)
Storage	0 to 90%

- a. The temperature range over which the calibration standards maintain performance to their specifications.
- b. The allowable network analyzer ambient temperature drift during measurement calibration and during measurements when the network analyzer error correction is turned on. Also, the range over which the network analyzer maintains its specified performance while correction is turned on.

Temperature—What to Watch Out For

Changes in temperature can affect electrical characteristics. Therefore, the operating temperature is a critical factor in performance. During a measurement calibration, the temperature of the calibration devices must be stable and within the range shown in [Table 2-1](#).

IMPORTANT Avoid unnecessary handling of the devices during calibration because your fingers act as a heat source and may increase the temperature of the device.

Mechanical Characteristics

For the mechanical characteristics and applicable specifications, please refer to the *“Microwave Test Accessories Catalog.”*

Electrical Characteristics and Specifications

Table 2-2 Electrical Characteristics and Specifications

Device	Frequency	Specification	Equivalent SWR
V11644A WR-15	50 to 75 GHz	Return loss \geq 38.2 dB	\pm 1.025
W11644A WR-10	75 to 110 GHz	Return loss \geq 36.6 dB	\pm 1.03
U11644A WR-19	40 to 60 GHz	Effective return loss \geq 46 dB ^a	
Q11644A WR-22	33 to 50 GHz	Effective return loss \geq 46 dB ^a	
R11644A WR-28	26.5 to 40 GHz	Effective return loss \geq 46 dB ^a	

a. Effective return loss accounts for line section, connector, and load stability as used in a network analyzer to define directivity after calibration.

Residual Errors after Calibration

The Agilent 8510 specifications and performance verification software can be used to obtain a printout of the residual errors after a calibration has been performed. Refer to the “Specifications and Performance Verification” section of the Agilent 8510C *On-Site Service Manual* for information on how to use the software.

Certification

Agilent Technologies certifies that this product met its published specifications at the time of shipment from the factory. Agilent further certifies that its calibration measurements are traceable to the United States National Institute of Standards and Technology (NIST) to the extent allowed by the institute’s calibration facility, and to the calibration facilities of other International Standards Organization members. See [“How Agilent Verifies the Devices in Your Kit” on page 5-2](#) for more information.

3 User Information

Calibration Devices and Their Use

The R, Q, U, V, and W11644 waveguide calibration kits may contain some or all of the following: short, standard section, termination loads, wavelength shim, and waveguide straights.

The following briefly describes the design and construction of all the calibration kit devices.

Short

A short is also called a flush short. It is connected directly to the test port, or used as an offset short when combined with the $\frac{1}{4}$ wavelength shim.

Standard Section

A standard section is used to check system operation after you complete a calibration.

Termination

A termination is also called a load. It is connected directly to the test port, or used as an offset load when combined with the $\frac{1}{4}$ wavelength shim.

$\frac{1}{4}$ Wavelength Shim

A $\frac{1}{4}$ wavelength shim is also called an offset, or $\frac{1}{4}$ wavelength section. The shim is terminated by the short, fixed load, or the second test port of the analyzer.

Waveguide Straight Section (verification device)

A waveguide straight is included as a system verification device. Be sure to keep it protected from wear and damage. When using it, always connect the same side, in the same orientation, for consistent and accurate mating.

Waveguide Straight Section (port 1 and 2)

Two waveguide straights, provided in this kit, are used as port 1 and port 2 measurement planes when properly connected to the directional couplers. Because these straight sections are used as port 1 and port 2 for device connections, they reduce wear that would otherwise occur to the coupler flanges. These particular straights should be replaced or renewed whenever the calibration devices are replaced or renewed.

Measurement Applications

NOTE For your convenience, two different lengths of screws are provided in this kit. While you can use the long screws for any connection, the *shorter screws* provide a faster connection for two-flange connections.

Isolation

In most cases, select the **OMIT ISOLATION** softkey on your network analyzer. You may also use the termination and the short as the port terminations by connecting one load to port 1 and the other load to port 2. See [Figure 3-1](#).

Figure 3-1 Termination and Short

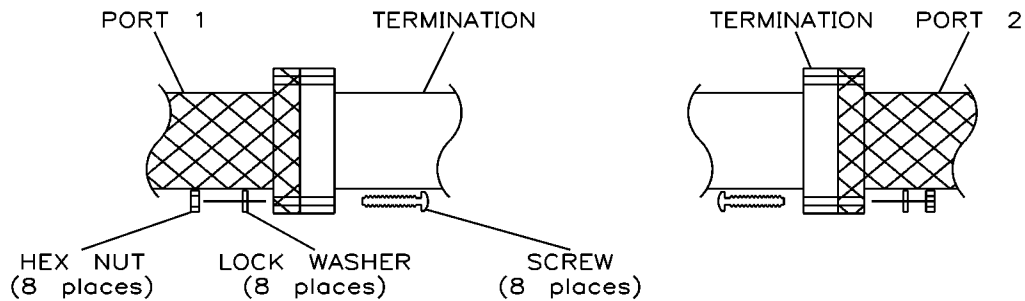

wx401a

Line

Connect the shim between port 1 and port 2, as shown in [Figure 3-2](#).

Figure 3-2 Connecting the Shim

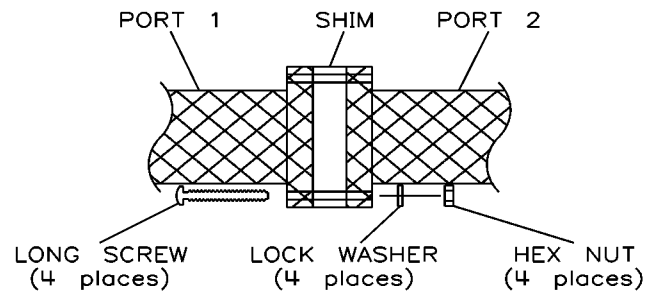

wx402a

Load

Connect the termination to the appropriate test port, as shown in [Figure 3-3](#).

Figure 3-3 Test Port and Termination

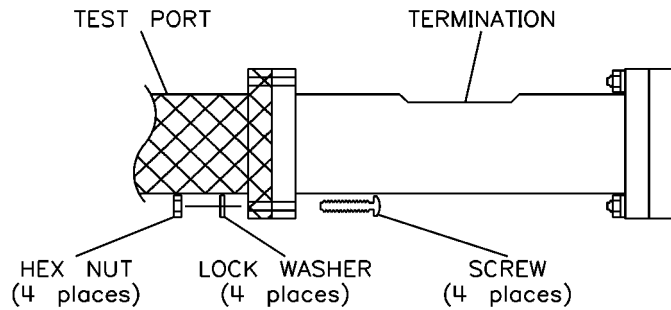

wx403a

Offset Load

Connect the shim and the termination to the appropriate test port, as shown in [Figure 3-4](#)

NOTE For offset load calibration with the R11644A WR-28, Q11644A WR-22, and U11644A WR-19, the moving load must be in a locked position. For more information refer to your network analyzer user's guide.

Figure 3-4 Connect the Shim and the Termination to the Test Port

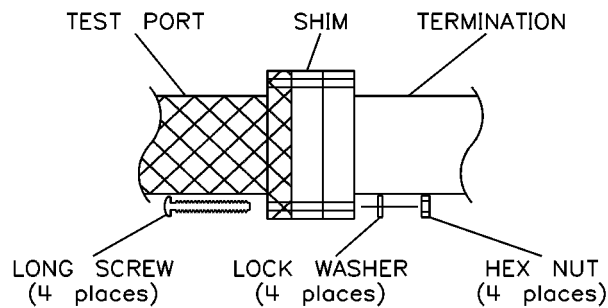

wx404a

Offset Short

Connect the shim and the short to the appropriate test port, as shown in [Figure 3-5](#).

Figure 3-5 Connect the Shim and the Short to the Test Port

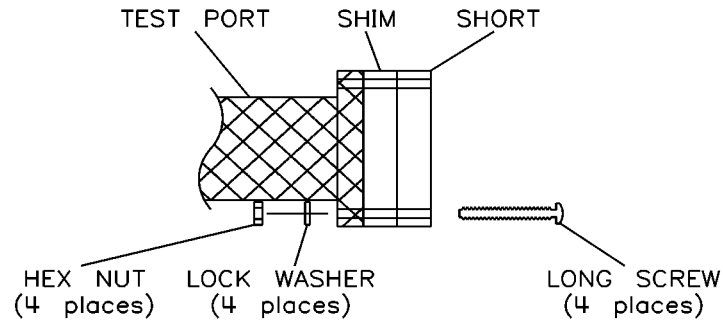

wx405a

Reflect

Connect the short to the appropriate test port, as shown in [Figure 3-6](#).

Figure 3-6 Connect the Short to the Test Port

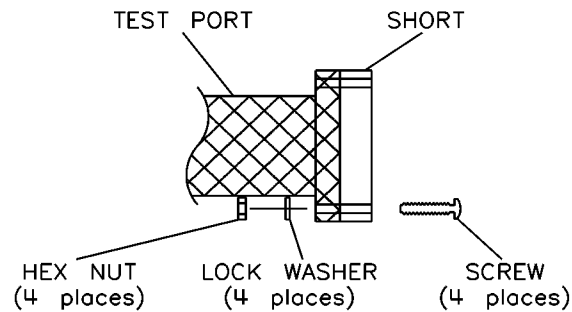

wx406a

Short

See [“Reflect.”](#)

Thru

No device is required for this. Connect port 1 to port 2, as shown in [Figure 3-7](#).

Figure 3-7 Connect Port 1 to Port 2

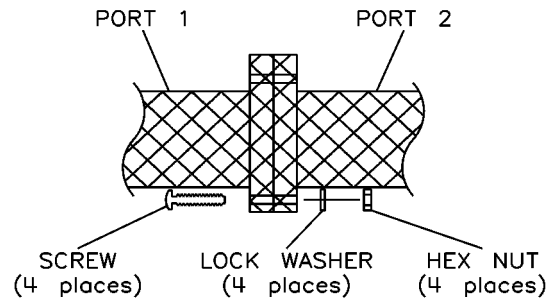

wx407a

$\frac{1}{4}$ Wavelength Load

See [“Offset Load.”](#)

$\frac{1}{4}$ Wavelength Short

See [“Offset Short.”](#)

Changing the ¼ Wavelength Shim Calibration Definition

The calibration kit definition data provided with this kit has a nominal value for the ¼ wavelength shim offset delay. You may use the nominal value provided, or measure the exact thickness of the shim and use that value to calculate its exact offset delay. Use the following procedure to change the nominal value of the ¼ wavelength shim delay to reflect the specific device in your kit.

1. Load the calibration kit data into Cal Kit 1.
2. Using the formula below, calculate the offset delay:

$$\frac{\text{length of } \frac{1}{4} \text{ wavelength section (mm)}}{299.6953 \frac{\text{mm}}{\text{ns}} (\text{propagation velocity in air})} = \text{offset delay (ns)}$$

NOTE The value of the propagation velocity in air is corrected for a temperature of 23 °C, 50% relative humidity, and 760 mm Hg of pressure.

4 Use, Maintenance, and Care of the Devices

Electrostatic Discharge

Protection against electrostatic discharge (ESD) is essential while connecting, inspecting, or cleaning connectors attached to a static-sensitive circuit (such as those found in test sets).

Static electricity can build up on your body and can easily damage sensitive internal circuit elements when discharged. Static discharges too small to be felt can cause permanent damage. Devices such as calibration components and devices under test (DUT), can also carry an electrostatic charge. To prevent damage to the test set, components, and devices:

- *Always* wear a grounded wrist strap having a 1 M Ω resistor in series with it when handling components and devices or when making connections to the test set.
- *Always* use a grounded antistatic mat in front of your test equipment.
- *Always* wear a heel strap when working in an area with a conductive floor. If you are uncertain about the conductivity of your floor, wear a heel strap.

Figure 4-1 shows a typical ESD protection setup using a grounded mat and wrist strap. Refer to Table 7-6 on page 7-14 for information on ordering supplies for ESD protection.

Figure 4-1 ESD Protection Setup

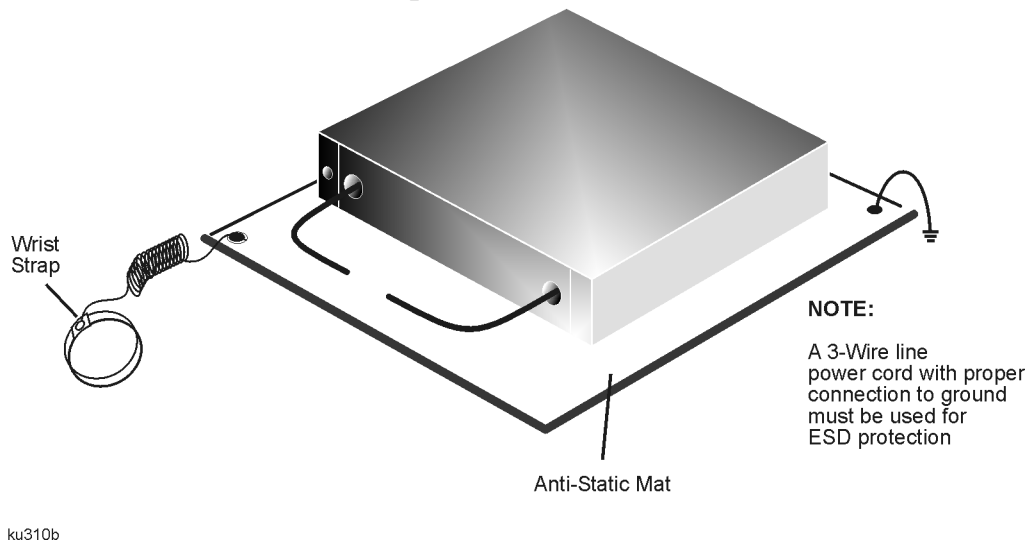

Visual Inspection

Visual inspection and, if necessary, cleaning should be done every time a connection is made. Inspect mating surfaces for dirt, dust, foreign particles, or scratches, which can degrade device performance. A damaged mating surface can damage any good surface connected to it. If necessary, clean all mating surfaces.

Cleaning the Mating Plane Surfaces

1. Use Compressed Air or Nitrogen

WARNING Always use protective eyewear when using compressed air or nitrogen.

Use compressed air (or nitrogen) to loosen particles on the mating plane surfaces. Clean air cannot damage a device or leave particles or residues behind.

You can use any source of clean, dry, low-pressure compressed air or nitrogen that has an effective oil-vapor filter and liquid condensation trap placed just before the outlet hose.

Ground the hose nozzle to prevent electrostatic discharge, and set the air pressure to less than 414 kPa (60 psi) to control the velocity of the air stream. High-velocity streams of compressed air can cause electrostatic effects when directed into a device. These electrostatic effects can damage the device. Refer to [“Electrostatic Discharge”](#) earlier in this chapter for additional information.

WARNING Keep isopropyl alcohol away from heat, sparks, and flame. Store in a tightly closed container. It is extremely flammable. In case of fire, use alcohol foam, dry chemical, or carbon dioxide; water may be ineffective.

Use isopropyl alcohol with adequate ventilation and avoid contact with eyes, skin, and clothing. It causes skin irritation, may cause eye damage, and is harmful if swallowed or inhaled. It may be harmful if absorbed through the skin. Wash thoroughly after handling.

In case of spill, soak up with sand or earth. Flush spill area with water.

Dispose of isopropyl alcohol in accordance with all applicable federal, state, and local environmental regulations.

2. Clean the Mating Plane Surfaces

- a. Apply a small amount of isopropyl alcohol to a lint-free cleaning swab.
- b. Clean the mating plane surfaces.
- c. Let the alcohol evaporate, then blow the mating plane surface dry with a gentle stream of clean, low-pressure compressed air or nitrogen. Always completely dry a device before you reassemble or use it.

3. Inspect

- a. Inspect the mating plane surface to make sure that no particles or residue remain. [“Visual Inspection”](#) on page 4-2.

Connections

Good connections require a skilled operator. Slight errors in operator technique can have a significant effect on measurements and measurement uncertainties. *The most common cause of measurement error is poor connections.*

The following procedures illustrate how to make good connections.

Waveguide Devices

IMPORTANT Unlike threaded devices, the WR-28, WR-22, WR-19, WR-15, and WR-10 waveguide mating planes are flanges (often precision) that you must carefully screw together. Always connect waveguide in the same flange orientation. For example, use the label as a reference and always connect a device with the label facing the same direction.

Precision Flanges

A precision flange has four corner screw holes *and* two precision alignment holes, as shown in [Figure 4-2](#). A non-precision flange has only four corner screw holes.

Figure 4-2 Precision Alignment Holes

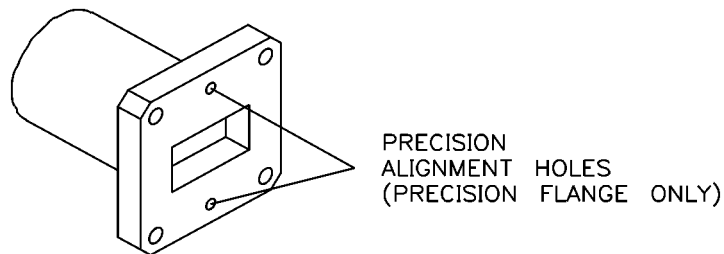

wx409a

Aligning Two Precision Flanges

1. Place the slip pins in the top and bottom holes of one flange, as shown in [Figure 4-3](#).

Figure 4-3 Inserting Slip Pins

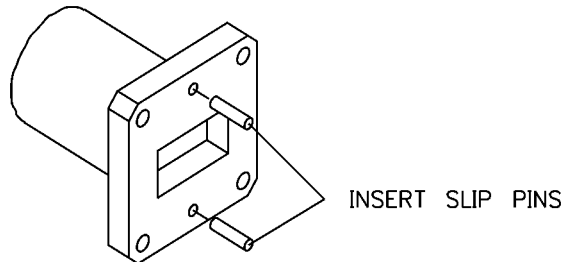

wx410a

2. Using the pins as guides, carefully align the flanges and insert two screws in the diagonal corner holes, as shown in [Figure 4-4](#).

Figure 4-4 Aligning Flanges

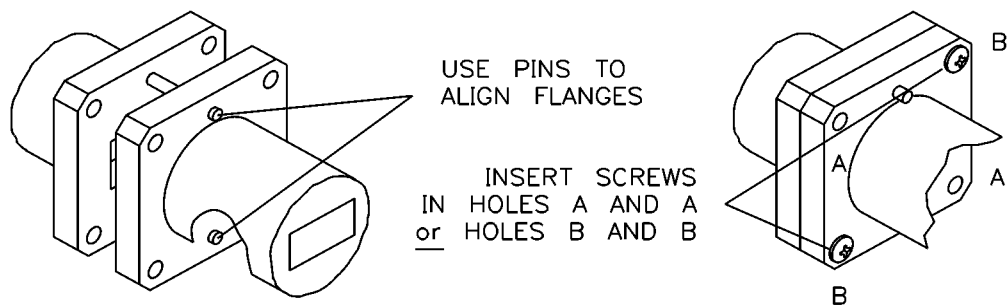

wx411a

3. Place a lock washer and nut on each screw, and finger tighten.
4. Insert the remaining two screws.
5. Place a lock washer and nut on each screw, and finger tighten.
6. Remove the slip pins.
7. Go to [“Tightening a Flange Connection”](#) on page 4-7.

Aligning a Precision and a Non-Precision Flange

1. Place an alignment pin (with head) in the corner hole of one flange. Place a second alignment pin in the diagonal corner hole of the second flange. See [Figure 4-5](#).

Figure 4-5 Aligning Pins

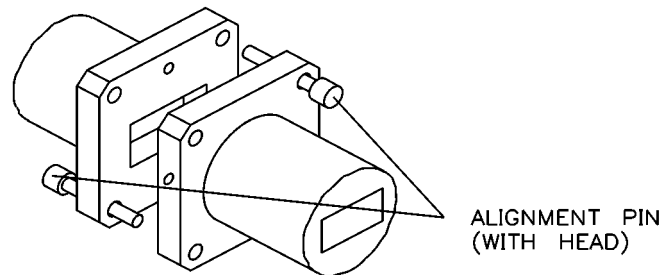

wx412a

2. Using the pins as guides, carefully align the flanges and insert screws in the diagonal corner holes.
3. Place a lock washer and nut on each screw, and finger tighten.
4. Remove the alignment pins and insert the remaining two screws.
5. Place a lock washer and nut on each screws, and finger tighten.
6. Go to [“Tightening a Flange Connection”](#) on page 4-7.

Tightening a Flange Connection

NOTE The best connection has symmetrical pressure applied as you gradually tighten the screws.

1. In an “X” pattern (for equal compression), tighten all four screws using a hex ball driver. Do *not* over-tighten. See [Figure 4-6](#).
2. Visually inspect the connection. Refer to the following section “[Inspecting a Flange Connection](#).”

Figure 4-6 “X” Screw Pattern

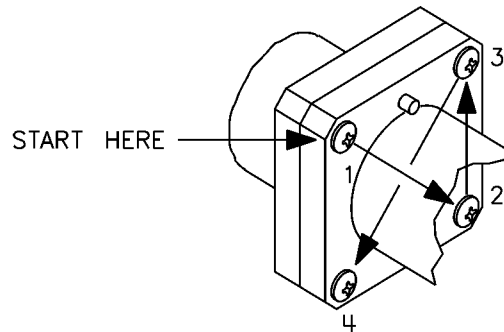

wx413a

Inspecting a Flange Connection

Inspect the flange connection as follows:

1. Place an electric light or white paper behind the connection.
2. Check the flange matings for any gap. A good connection has no gaps between the connected waveguide flanges, and the waveguide walls are flush. There is no step or offset.
3. Ensure that all four screws are equally tight.

NOTE The most common cause of measurement error is a poor connection.

Handling and Storage

- Install the protective end caps and store the calibration devices in the foam-lined storage case when not in use.
- Never store devices loose in a box, or in a desk or bench drawer. This is the most common cause of device damage during storage.
- Keep devices clean.
- Do not touch mating plane surfaces. Natural skin oils and microscopic particles of dirt are easily transferred to a device and are very difficult to remove.
- Do not set devices contact-end down on a hard surface. The plating and the mating plane surfaces can be damaged if the interface comes in contact with any hard surface.

5 Performance Verification

Introduction

The performance of your calibration kit can only be verified by returning the kit to Agilent Technologies for recertification. The equipment and calibration standards required to verify the specifications of the limits of the devices in the kit have been specially manufactured and are not commercially available. However, you may check the performance of the terminations in this kit by following the procedure “[Termination Return Loss Measurement](#)” on page 5-4.

To confirm that your calibration kit is performing accurate calibrations, use the appropriate Agilent 11645A verification kit with the “Specifications & Performance Verification” disk included in this kit.

How Agilent Verifies the Devices in Your Kit

Agilent verifies the specifications of these devices as follows:

1. The residual microwave error terms of the test system are verified with precision airlines and shorts that are directly traced to the National Institute of Standards and Technology (NIST). The airline and short characteristics are developed from mechanical measurements. The mechanical measurements and material properties are carefully modeled to give very accurate electrical representation. The mechanical measurements are then traced to NIST through various plug and ring gages and other mechanical measurements.
2. Each calibration device is electrically tested on this system. For the initial (before sale) testing of the calibration devices, Agilent includes the test measurement uncertainty as a guardband to guarantee each device meets the published specification. For recertifications (after sale), no guardband is used and the measured data is compared directly with the specification to determine the pass or fail status. The measurement uncertainty for each device is, however, recorded in the calibration report that accompanies recertified kits.

These two steps establish a traceable link to NIST for Agilent to the extent allowed by the institute’s calibration facility. The specifications data provided for the devices in the kit is traceable to NIST through Agilent Technologies.

Recertification

The following will be provided with a recertified kit:

- a new calibration sticker affixed to the case
- a certificate of calibration
- a calibration report for each device in the kit listing measured values, specifications, and uncertainties

NOTE A list of NIST traceable numbers may be purchased upon request to be included in the calibration report.

Agilent Technologies offers a *Standard* calibration for the recertification of the kit. For more information, contact Agilent Technologies. Refer to [“Contacting Agilent” on page 6-4](#) for a list of offices.

How Often to Recertify

The suggested initial interval for recertification is 12 months or sooner. The actual need for recertification depends on the use of the kit. After reviewing the results of the initial recertification, you may establish a different recertification interval that reflects the usage and wear of the kit.

NOTE The recertification interval should begin on the date the kit is *first used* after the recertification date.

Where to Send a Kit for Recertification

Contact Agilent Technologies for information on where to send your kit for recertification. Contact information is listed on [page 6-4](#). Refer to [“Returning a Kit or Device to Agilent” on page 6-4](#) for details on sending your kit.

Performance Test

Termination Return Loss Measurement

Use this test to check the performance of the terminations in this kit.

Figure 5-1 Return Loss Test Setup

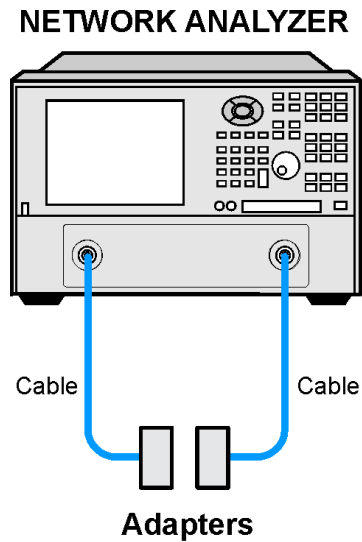

wx425a

1. Connect the equipment as shown in [Figure 5-1](#). Turn on and preset the network analyzer. Let the equipment warm up for at least one hour.

NOTE The calibration kit definitions must already be loaded in the analyzer. Refer to your analyzer user's guide for information on how to load the calibration kit definitions.

2. Set the appropriate start frequency to:
 - 26.5 GHz (R-band)
 - 33 GHz (Q-band)
 - 40 GHz (U-band)
 - 50 GHz (V-band)
 - 75 GHz (W-band)

3. Set the appropriate stop frequency to:
 - 40 GHz (R-band)
 - 50 GHz (Q-band)
 - 60 GHz (U-band)
 - 75 GHz (V-band)
 - 110 GHz (W-band)
4. Set the averaging factor to 512.
5. At the adapter test port, perform a 2–port TRL calibration.
6. Turn on the calibration.
7. Connect the termination you wish to test to port 1.
8. Measure the return loss (S_{11}) of the load.
9. After one complete measurement sweep, the displayed trace should look similar to that shown in [Figure 5-2](#).
10. If necessary, update the trace.
11. Use a marker to determine the maximum value on the trace. This marker determines worst-case return loss.

Figure 5-2 Typical Termination Return Loss

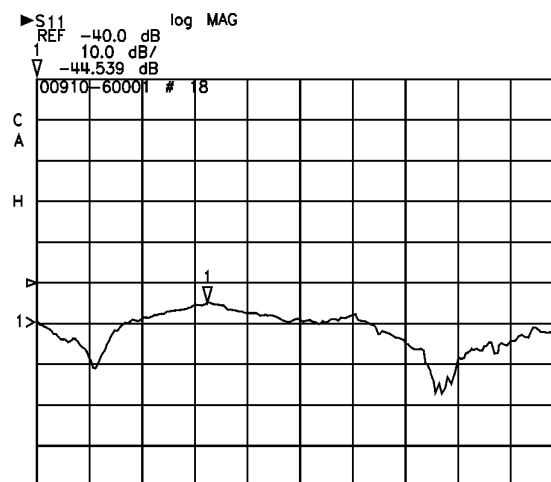

wx415a

In Case of Failure

If a termination fails this test, clean all flanges and carefully reconnect the devices. Repeat the test. If the termination fails again, replace it. Refer to [Table 2-2, “Electrical Characteristics and Specifications,”](#) on page 2-3.

6 Troubleshooting

Troubleshooting Process

This manual contains limited information about network analyzer system operation. For complete information, refer to the instrument documentation.

If you suspect a bad calibration, or if your network analyzer does not pass performance verification, follow the steps in [Figure 6-1](#).

Figure 6-1 Troubleshooting Flowchart

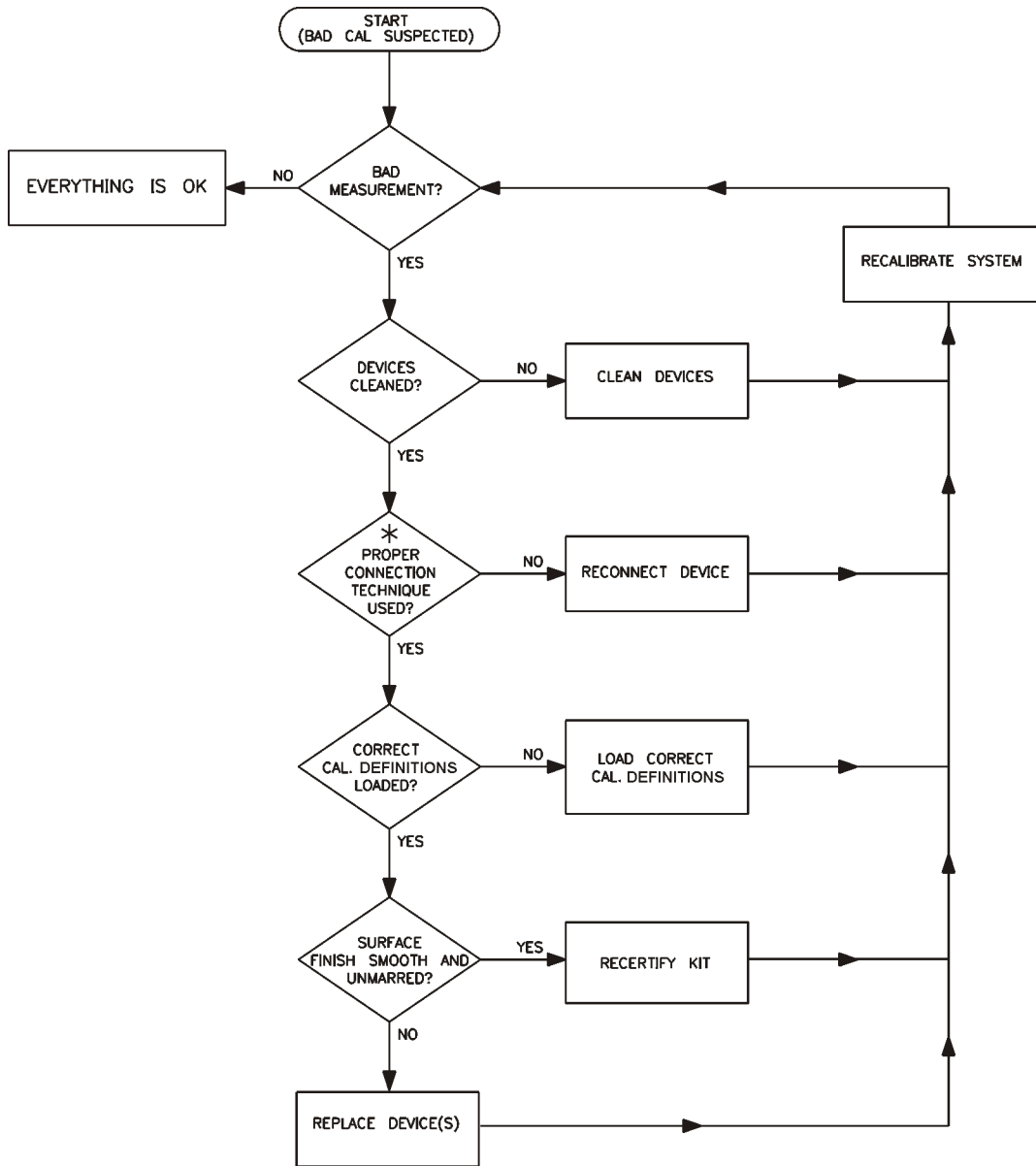

* NO GAPS; WAVEGUIDE WALLS FLUSH;
EVEN AND SYMMETRICAL TIGHTENING.

wx416a

Returning a Kit or Device to Agilent

If your kit or device requires service, contact Agilent Technologies for information on where to send it. See [Table 6-1](#) for contact information. Include a service tag (located near the end of this manual) on which you provide the following information:

- your company name and address
- a technical contact person within your company, and the person's complete telephone number
- the model number and serial number of the kit
- the part number and serial number of each device
- the type of service required
- a *detailed* description of the problem and how the device was being used when the problem occurred (such as calibration or measurement)

Where to Look for More Information

This manual contains limited information about network analyzer system operation. For complete information, refer to the instrument documentation. If you need additional information, contact Agilent Technologies.

Contacting Agilent

Table 6-1 Contacting Agilent

Online assistance: www.agilent.com/find/assist			
United States <i>(tel)</i> 1 800 452 4844	Latin America <i>(tel)</i> (305) 269 7500 <i>(fax)</i> (305) 269 7599	Canada <i>(tel)</i> 1 877 894 4414 <i>(fax)</i> (905) 282-6495	Europe <i>(tel)</i> (+31) 20 547 2323 <i>(fax)</i> (+31) 20 547 2390
New Zealand <i>(tel)</i> 0 800 738 378 <i>(fax)</i> (+64) 4 495 8950	Japan <i>(tel)</i> (+81) 426 56 7832 <i>(fax)</i> (+81) 426 56 7840	Australia <i>(tel)</i> 1 800 629 485 <i>(fax)</i> (+61) 3 9210 5947	Singapore <i>(tel)</i> 1 800 375 8100 <i>(fax)</i> (65) 836 0252
Malaysia <i>(tel)</i> 1 800 828 848 <i>(fax)</i> 1 800 801 664	Philippines <i>(tel)</i> (632) 8426802 <i>(tel)</i> (PLDT subscriber only): 1 800 16510170 <i>(fax)</i> (632) 8426809 <i>(fax)</i> (PLDT subscriber only): 1 800 16510288	Thailand <i>(tel)</i> outside Bangkok: (088) 226 008 <i>(tel)</i> within Bangkok: (662) 661 3999 <i>(fax)</i> (66) 1 661 3714	Hong Kong <i>(tel)</i> 800 930 871 <i>(fax)</i> (852) 2506 9233
Taiwan <i>(tel)</i> 0800-047-866 <i>(fax)</i> (886) 2 25456723	People's Republic of China <i>(tel)</i> (preferred): 800-810-0189 <i>(tel)</i> (alternate): 10800-650-0021 <i>(fax)</i> 10800-650-0121	India <i>(tel)</i> 1-600-11-2929 <i>(fax)</i> 000-800-650-1101	

7 Replaceable Parts

This page is intentionally left blank.

Introduction

The following tables list the replacement part numbers for the Agilent R, Q, U, V, and W11644A waveguide calibration kits. [Table 7-6](#) lists the replacement part numbers for items *not* included in the calibration kit that are either required or recommended for successful operation of this kit.









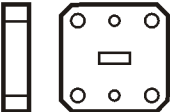

To order a listed part, note the description, part number, and the quantity desired. Telephone or send your order to Agilent Technologies. Refer to [“Contacting Agilent” on page 6-4](#) for further information.

Table 7-1 Replaceable Parts for the R11644A WR-28

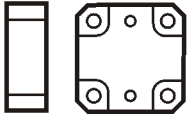
Description	Qty Per Kit	Agilent Part Number
Calibration Devices		
Straight section (5 cm)	2	11644-60016
Standard section (10 cm)	1	11644-60001
Waveguide load	1	11644-60004
Short	1	11644-20005
Shim	1	11644-20003
Hardware		
Alignment pin	6	11644-20009
Slip pin (2.367 mm diameter)	6	11644-20006
4-40 Hex nut (0.094 inch)	12	2260-0002
4-40 SKT HD screw (0.750 inch)	12	3030-0721
Lock washer (0.115 inch)	12	2190-0030
Open end wrench	1	8720-0013
Hex ball driver	1	8710-0523
Miscellaneous Items		
User's and service guide	1	11644-90369
Calibration definitions disk (R)	1	11644-10012
Calibration definitions disk (PNA)	1	11644-10020
Specifications and performance verification disk ^a	1	08510-10033
Connector care quick-reference card	1	08510-90360
Calibration Kit Storage Case		
Storage case	1	5181-5517
Box	2	1540-0034
Foam pad (set)	1	11644-80040
Disk holder	1	5180-8491

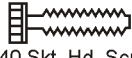
a. See the 8510C *On-Site Service Manual* for instructions on using this disk.

Figure 7-1 R-Band Component Identification Sheet

<p>Standard Section (10 cm)</p> <p>Used for system verification only.</p> 		
<p>Waveguide Load</p> 		
<p>1/4 Wavelength Section</p>  <p>Has mechanical length labeled on side or recessed area.</p>	<p>Straight Section (5 cm)</p>  <p>Used as port 1 and 2</p> <p>3/32 inch Hex Ball Driver</p> 	
<p>Flush Short</p> 	<p>Slip Pin (2.367 mm diameter)</p>  <p>Alignment Pin (long)</p>  <p>4-40 Skt. Hd. Screw</p>  <p>Lock Washer</p>  <p>4-40 Hex Nut</p> 	<p>Data Disc</p> 









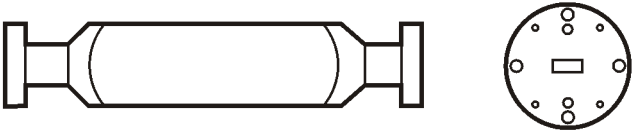

Note: Short pins used on calibration devices, long pins used on DUTs.

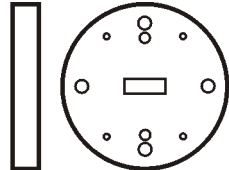
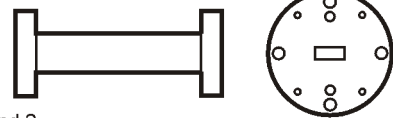
Table 7-2 Replaceable Parts for the Q11644A WR-22

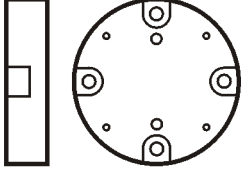
Description	Qty Per Kit	Agilent Part Number
Calibration Devices		
Straight section (5 cm)	2	11644-60017
Standard section (10 cm)	1	11644-60002
Waveguide load	1	11644-60005
Shim	1	11644-20001
Short	1	11644-20004
Hardware		
Slip pin (1.645 mm diameter)	6	11644-20008
Slip pin (2.367 mm diameter)	6	11644-20006
4-40 captive screw (0.31 inches long)	24	1390-0671
4-40 captive screw (0.43 inches long)	12	1390-0764
4-40 SKT HD screw (0.50 inches long)	12	3030-0203
Hex ball driver	1	8710-0523
Miscellaneous Items		
Calibration definitions disk (Q-band)	1	11644-10013
Calibration definitions disk (PNA)	1	11644-10019
Specifications and performance verification disk ^a	1	08510-10033
User's and service guide	1	11644-90369
Connector care-quick reference card	1	08510-90360
Calibration Kit Storage Case		
Storage case	1	5181-5517
Box	2	1540-0034
Foam pad (set)	1	11644-80041
Disk holder	1	5180-8491

a. See the 8510C *On-Site Service Manual* for instructions on using this disk.

Figure 7-2 Q-Band Component Identification Sheet

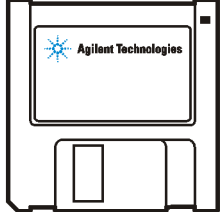
<p>Standard Section (10 cm)</p> <p>Used for system verification only.</p> 		
<p>Waveguide Load</p> 		
<p>Wavelength Section</p>  <p>Has mechanical length labeled on side or recessed area.</p>	<p>Straight Section (5 cm)</p>  <p>Used as port 1 and 2</p> <p>3/32 inch Hex Ball Driver</p> 	
<p>Flush Short</p> 	<p>Slip Pin (2.367 mm diameter)</p>  <p>Slip Pin (1.645 mm diameter)</p>  <p>4-40 Socket Head Screw</p>  <p>4-40 Captive Screw</p>  <p>4-40 Captive Screw</p> 	<p>Data Disc</p> 

Note: Short pins used on calibration devices, long pins used on DUTs.







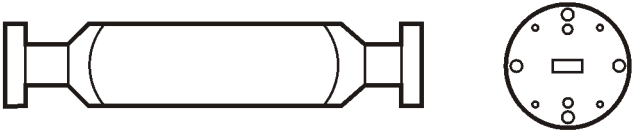
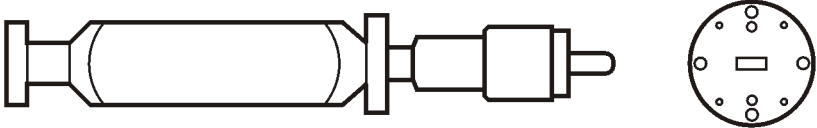
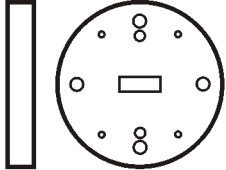
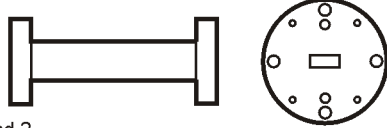

wx418a

Table 7-3 Replaceable Parts for the U11644A WR-19

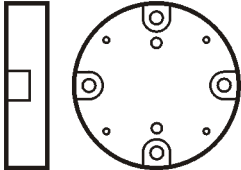
Description	Qty Per Kit	Agilent Part Number
Calibration Devices		
Straight section (5 cm)	2	11644-60018
Standard section (10 cm)	1	11644-60003
Waveguide load	1	11644-60006
Shim	1	11644-20002
Short	1	11644-20004
Hardware		
Slip pin (1.645 mm diameter)	6	11644-20008
Slip pin (2.367 mm diameter)	6	11644-20006
4-40 captive screw (0.31 inches long)	24	1390-0671
4-40 captive screw (0.43 inches long)	12	1390-0764
4-40 SKT HD screw (0.50 inches long)	12	3030-0203
Hex ball driver	1	8710-0523
Miscellaneous Items		
Calibration definitions disk (U-band)	1	11644-10014
Calibration definitions disk (PNA)	1	11644-10019
Specifications and performance verification disk ^a	1	08510-10033
User's and service guide	1	11644-90369
Connector care-quick reference card	1	08510-90360
Calibration Kit Storage Case		
Storage case	1	5181-5517
Box	2	1540-0034
Foam pad (set)	1	11644-80041
Disk holder	1	5180-8491

a. See the 8510C *On-Site Service Manual* for instructions on using this disk.

Figure 7-3 U-Band Component Identification Sheet

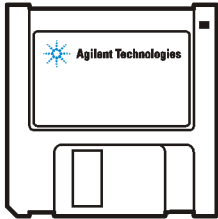
<p>Standard Section (10 cm)</p> <p>Used for system verification only.</p> 		
<p>Waveguide Load</p> 		
<p>Wavelength Section</p>  <p>Has mechanical length labeled on side or recessed area.</p>	<p>Straight Section (5 cm)</p>  <p>Used as port 1 and 2</p> <p>3/32 inch Hex Ball Driver</p> 	
<p>Flush Short</p> 	<p>Slip Pin (2.367 mm diameter)</p>  <p>Slip Pin (1.645 mm diameter)</p>  <p>4-40 Socket Head Screw</p>  <p>4-40 Captive Screw</p>  <p>4-40 Captive Screw</p> 	<p>Data Disc</p> 

Note: Short pins used on calibration devices, long pins used on DUTs.









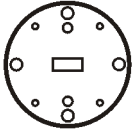

wx418a

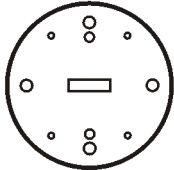
Table 7-4 Replaceable Parts for the V11644A WR-15

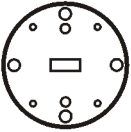
Description	Qty Per Kit	Agilent Part Number
Calibration Devices		
Fixed load	1	11644-60025
Standard section (5 cm)	3	11644-60012
Shim	1	11644-20013
Short	1	11644-20015
Hardware		
Slip pin (1.567 mm diameter)	6	11644-20007
4-40 captive screw (0.41 inch)	12	1390-0765
4-40 captive screw (0.31 inch)	24	1390-0671
Hex ball driver	1	8710-0523
Miscellaneous Items		
Calibration definitions disk (V-band)	1	11644-10015
Specifications and performance verification disk ^a	1	08510-10033
User's and service guide	1	11644-90369
Connector care-quick reference card	1	08510-90360
Calibration Kit Storage Case		
Storage case	1	5181-5517
Box	2	1540-0034
Foam pad (set)	1	11644-80042
Disk holder	1	5180-8491

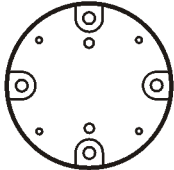
a. See the 8510C *On-Site Service Manual* for instructions on using this disk.

Figure 7-4 V-Band Component Identification Sheet

<p>Fixed Load</p>  		
<p>Shim</p>   <p>Has mechanical length labeled on side or recessed area.</p>	<p>Standard Section (5 cm)</p>   <ul style="list-style-type: none"> • Used for system verification only (1) • Used as port 1 and 2 (2) 	<p>3/32 inch Hex Ball Driver</p> 
<p>Flush Short</p>  	<p>Slip Pin (1.567 mm diameter)</p>  <p>4-40 Captive Screw</p>  <p>4-40 Captive Screw</p> 	<p>Data Disc</p> 

Note: Short pins used on calibration devices, long pins used on DUTs.









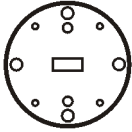

wx419a

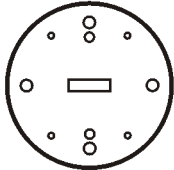
Table 7-5 Replaceable Parts for the W11644A WR-10

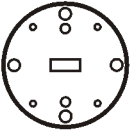
Description	Qty Per Kit	Agilent Part Number
Calibration Devices		
Fixed load	1	11643-60026
Standard section	3	11644-60013
Shim	1	11644-20014
Short	1	11644-20015
Hardware		
Slip pin (1.567 mm diameter)	6	11644-20007
4-40 captive screw (0.41 inch)	12	1390-0765
4-40 captive screw (0.31 inch)	24	1390-0671
Hex ball driver	1	8710-0523
Miscellaneous Items		
Calibration definitions disk (W-band)	1	11644-10016
Specifications and performance verification disk ^a	1	08510-10033
User's and service guide	1	11644-90369
Connector care-quick reference card	1	08510-90360
Calibration Kit Storage Case		
Storage case	1	5181-5517
Box	2	1540-0034
Foam pad (set)	1	11644-80042
Disk holder	1	5180-8491

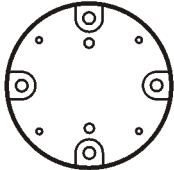
a. See the 8510C *On-Site Service Manual* for instructions on using this disk.

Figure 7-5 W-Band Component Identification Sheet

<p>Fixed Load</p>  		
<p>Shim</p>   <p>Has mechanical length labeled on side or recessed area.</p>	<p>Standard Section (5 cm)</p>   <ul style="list-style-type: none"> • Used for system verification only (1) • Used as port 1 and 2 (2) 	<p>3/32 inch Hex Ball Driver</p> 
<p>Flush Short</p>  	<p>Slip Pin (1.567 mm diameter)</p>  <p>4-40 Captive Screw</p>  <p>4-40 Captive Screw</p> 	<p>Data Disc</p> 

Note: Short pins used on calibration devices, long pins used on DUTs.

wx419a

Table 7-6 Items Not Included in the Calibration Kit

Description	Qty	Agilent Part Number
ESD Protection Devices		
Grounding wrist strap	1	9300-1367
5 ft grounding cord for wrist strap	1	9300-0980
2 ft by 4 ft conductive table mat with 15 ft grounding wire	1	9300-0797
ESD heel strap	1	9300-1308
Cleaning Supplies		
Isopropyl alcohol	30 ml	8500-5344
Foam-tipped cleaning swabs	100	9301-1243

A Standard Definitions

Standard Class Assignments

Class assignment organizes calibration standards into a format compatible with the error models used in the measurement calibration. A class or group of classes corresponds to the systematic errors to be removed from the measured network analyzer response. Tables A-1 through A-3 list the classes of the devices in the kit for the 8510 and PNA series respectively. This information resides on the calibration definitions disks included in the kit. Some network analyzers have the information stored in memory.

Table A-1 Standard Class Assignments for the 8510 (WR-19, WR-22, and WR-28)

Disk File Name: CK_WR-28, or CK_WR-22, or CK_WR-19				Calibration Kit Label: WR-28 A.2, or WR-22 A.2, or WR-19 A.2				
Class	A	B	C	D	E	F	G	Standard Class Label
S ₁₁ A	1							Short
S ₁₁ B	3							Offset
S ₁₁ C	9	10	20					Loads
S ₂₂ A	1							Short
S ₂₂ B	3							Offset
S ₂₂ C	9	10	20					Loads
Forward transmission	11							Thru
Reverse transmission	11							Thru
Forward match	11							Thru
Reverse match	11							Thru
Frequency response	1	11						Response

Table A-2 Standard Class Assignments for the 8510 (WR-10 and WR-15)

Disk File Name: CK_WR-15, or CK_WR-10				Calibration Kit Label: WR-15 A.2, or WR-10 A.2				
Class	A	B	C	D	E	F	G	Standard Class Label
S ₁₁ A	1							Short
S ₁₁ B	3							Offset
S ₁₁ C	9	20						Loads
S ₂₂ A	1							Short
S ₂₂ B	3							Offset
S ₂₂ C	9	20						Loads
Forward transmission	11							Thru
Reverse transmission	11							Thru
Forward match	11							Thru
Reverse match	11							Thru
Frequency response	1	11						Response

Table A-3 Standard Class Assignments for the PNA Series Network Analyzer

Calibration Kit Label: PNA Series	
Class	A ^a
S ₁₁ A	1
S ₁₁ B	2
S ₁₁ C	3, 4, 5
Forward transmission	6, 7, 8
S ₂₂ A	1
S ₂₂ B	2
S ₂₂ C	3, 4, 5
Isolation	3, 4, 5

a. For additional ports, make sure values match the correct sex of the port.

IMPORTANT The following calibrations are only supported by certain PNA analyzers. See your PNA network analyzer embedded help system.

Notes:

1. If you are performing a TRL calibration:

- S₂₁T and S₁₂T must be defined as *thru* standards.
- S₁₁A and S₂₂A must be defined as *reflection* standards.
- S₁₁B, S₁₁C, S₂₂B, and S₂₂C must be defined as *line* standards.

2. If you are performing a TRM calibration:

- S₂₁T and S₁₂T must be defined as *thru* standards.
- S₁₁A and S₂₂A must be defined as *reflection* standards.
- S₁₁B, S₁₁C, S₂₂B, and S₂₂C must be defined as *match* standards.

3. If you are performing an LRM calibration:

- S₂₁T and S₁₂T must be defined as *line* standards.
- S₁₁A and S₂₂A must be defined as *reflection* standards.
- S₁₁B, S₁₁C, S₂₂B, and S₂₂C must be defined as *match* standards.

4. S₁₁B and S₁₁C must be defined as the same standard.

5. S₂₂B and S₂₂C must be defined as the same standard.

Blank Forms

The standard class assignments may be changed to meet your specific requirements. The following two tables are provided to record the modified standard class assignments.

Table A-4 Blank Form for the 8510 Network Analyzer

Disk File Name: _____				Calibration Kit Label: _____				
Class	A	B	C	D	E	F	G	Standard Class Label
S ₁₁ A								
S ₁₁ B								
S ₁₁ C								
S ₂₂ A								
S ₂₂ B								
S ₂₂ C								
Forward transmission								
Reverse transmission								
Forward match								
Reverse match								
Frequency response								

Table A-5 Blank Form for the PNA Series Network Analyzers

Calibration Kit Label:	
Class	A ^a
S ₁₁ A	
S ₁₁ B	
S ₁₁ C	
Forward transmission	
S ₂₂ A	
S ₂₂ B	
S ₂₂ C	
Isolation	

a. For additional ports, make sure values match the correct sex of the port.

IMPORTANT The following calibrations are only supported by certain PNA analyzers. See your PNA network analyzer embedded help system.

Notes:

1. If you are performing a TRL calibration:

- S₂₁T and S₁₂T must be defined as *thru* standards.
- S₁₁A and S₂₂A must be defined as *reflection* standards.
- S₁₁B, S₁₁C, S₂₂B, and S₂₂C must be defined as *line* standards.

2. If you are performing a TRM calibration:

- S₂₁T and S₁₂T must be defined as *thru* standards.
- S₁₁A and S₂₂A must be defined as *reflection* standards.
- S₁₁B, S₁₁C, S₂₂B, and S₂₂C must be defined as *match* standards.

3. If you are performing an LRM calibration:

- S₂₁T and S₁₂T must be defined as *line* standards.
- S₁₁A and S₂₂A must be defined as *reflection* standards.
- S₁₁B, S₁₁C, S₂₂B, and S₂₂C must be defined as *match* standards.

4. S₁₁B and S₁₁C must be defined as the same standard.

5. S₂₂B and S₂₂C must be defined as the same standard.

Nominal Standard Definitions

Standard definitions provide the constants needed to mathematically model the electrical characteristics (delay, attenuation, and impedance) of each calibration standard. The nominal values of these constants are theoretically derived from the physical dimensions and material of each calibration standard, or from actual measured response. These values are used to determine the measurement uncertainties of the network analyzer. The standard definitions in [Tables A-6](#) through [A-15](#) list typical calibration kit parameters used by the 8510, 872*x*, and PNA series to specify the mathematical model of each device. This information must be loaded into the network analyzer to perform valid calibrations. Refer to your network analyzers user's guide for instructions on loading calibration definitions.

NOTE The values in the standard definitions table are valid *only* over the specified operating temperature range.

Setting the System Impedance

This kit contains only 50 ohm devices. Ensure the system impedance (Z_0) is set to 50 ohms. Refer to your network analyzer user's guide for instructions on setting system impedance.

Version Changes

Class assignments and standard definitions may change as more accurate model and calibration methods are developed. The disk shipped with the kit for use with the 8510 will contain the most recent version. The default version that comes with the 872*x* network analyzer firmware may be outdated.

Table A-6 Standard Definitions for the 8510 with R-band (WR-28)

System $Z_0^a = 50.0 \Omega$ Calibration Kit Label: WR-28 A.3													
Disk File Name: CK_WR-28													
Number	Standard ^b Type	$C0 \times 10^{-15} F$	$C1 \times 10^{-27} F/Hz$	$C2 \times 10^{-36} F/Hz^2$	$C3 \times 10^{-45} F/Hz^3$	Fixed, Sliding, or Offset ^c	Offset			Frequency in GHz ^d		Coax or Waveguide	Standard Label
		$L0 \times 10^{-12} H$	$L1 \times 10^{-24} H/Hz$	$L2 \times 10^{-33} H/Hz^2$	$L3 \times 10^{-42} H/Hz^3$		Delay in ps	$Z_0 \Omega$	Loss in GΩ/s	Min	Max		
1	Short ^e						0	50	0	21.071	42.142	WG	Short
2													
3	Short ^e						10.0702	50	0	21.071	42.142	WG	$\lambda/4$ Offset
4													
5													
6													
7													
8													
9	Load					Fixed	0	50	0	21.071	42.142	WG	Fixed
10	Load					Sliding	0	50	0	21.071	42.142	WG	Sliding
11	Delay/ thru						0	50	0	21.071	42.142	WG	Thru
12													
13	Undefined												
14	Delay/ thru						0	50	0	21.069	42.138	WG	Thru
15	Delay/ thru						10.0702	50	0	21.069	42.138	WG	$\lambda/4$ Delay
16													
17													
18													
19													
20	Load					Offset	10.0702	50	0	21.071	42.142	WG	$\lambda/4$ Offset
21													

- a. Ensure system Z_0 of network analyzer is set to this value.
- b. Open, short, load, delay/thru, or arbitrary impedance.
- c. Load or arbitrary impedance only.
- d. For waveguide, the lower frequency is the same as F_{CO} .
- e. Typical values only. Disk values may be different.

Table A-7 Standard Definitions for the 8510 with Q-band (WR-22)

Standard ^b		$C0 \times 10^{-15}$ F	$C1 \times 10^{-27}$ F/Hz	$C2 \times 10^{-36}$ F/Hz ²	$C3 \times 10^{-45}$ F/Hz ³	Fixed, Sliding, or Offset ^c	Offset			Frequency in GHz ^d		Coax or Waveguide	Standard Label
Number	Type	$L0 \times 10^{-12}$ H	$L1 \times 10^{-24}$ H/Hz	$L2 \times 10^{-33}$ H/Hz ²	$L3 \times 10^{-42}$ H/Hz ³		Delay in ps	Z_0 Ω	Loss in G Ω /s	Min	Max		
1	Short ^e						0	50	0	26.338	52.676	WG	Short
2													
3	Short ^e						8.082	50	0	26.338	52.676	WG	$\lambda/4$ Offset
4													
5													
6													
7													
8													
9	Load					Fixed	0	50	0	26.338	52.676	WG	Fixed
10	Load					Sliding	0	50	0	26.338	52.676	WG	Sliding
11	Delay/ thru						0	50	0	26.338	52.676	WG	Thru
12													
13	Undefined												
14	Delay/ thru						0	50	0	26.338	52.676	WG	Thru
15	Delay/ thru						8.084	50	0	26.338	52.676	WG	$\lambda/4$ Delay
16													
17													
18													
19													
20	Load					Offset	8.082	50	0	26.338	52.676	WG	$\lambda/4$ Offset
21													

- a. Ensure system Z_0 of network analyzer is set to this value.
- b. Open, short, load, delay/thru, or arbitrary impedance.
- c. Load or arbitrary impedance only.
- d. For waveguide, the lower frequency is the same as F_{CO} .
- e. Typical values only. Disk values may be different.

Table A-8 Standard Definitions for the 8510 with U-band (WR-19)

System $Z_0^a = 50.0 \Omega$ Calibration Kit Label: WR-19 A.3													
Disk File Name: CK_WR-19													
Number	Standard ^b Type	$C0 \times 10^{-15} F$	$C1 \times 10^{-27} F/Hz$	$C2 \times 10^{-36} F/Hz^2$	$C3 \times 10^{-45} F/Hz^3$	Fixed, Sliding, or Offset ^c	Offset			Frequency in GHz ^d		Coax or Waveguide	Standard Label
		$L0 \times 10^{-12} H$	$L1 \times 10^{-24} H/Hz$	$L2 \times 10^{-33} H/Hz^2$	$L3 \times 10^{-42} H/Hz^3$		Delay in ps	$Z_0 \Omega$	Loss in GΩ/s	Min	Max		
1	Short ^e						0	50	0	31.386	62.772	WG	Short
2													
3	Short ^e						6.643	50	0	31.386	62.772	WG	λ/4 Offset
4													
5													
6													
7													
8													
9	Load					Fixed	0	50	0	31.386	62.772	WG	Fixed
10	Load					Sliding	0	50	0	31.386	62.772	WG	Sliding
11	Delay/ thru						0	50	0	31.386	62.772	WG	Thru
12													
13	Undefined												
14	Delay/ thru						0	50	0	31.386	62.772	WG	Thru
15	Delay/ thru						6.646	50	0	31.386	62.772	WG	λ/4 Delay
16													
17													
18													
19													
20	Load					Offset	6.643	50	0	31.386	62.772	WG	λ/4 Offset
21													

- a. Ensure system Z_0 of network analyzer is set to this value.
- b. Open, short, load, delay/thru, or arbitrary impedance.
- c. Load or arbitrary impedance only.
- d. For waveguide, the lower frequency is the same as F_{CO} .
- e. Typical values only. Disk values may be different.

Table A-9 Standard Definitions for the 8510 with V-band (WR-15)

Standard ^b		$C0 \times 10^{-15}$ F	$C1 \times 10^{-27}$ F/Hz	$C2 \times 10^{-36}$ F/Hz ²	$C3 \times 10^{-45}$ F/Hz ³	Fixed, Sliding, or Offset ^c	Offset			Frequency in GHz ^d		Coax or Waveguide	Standard Label
Number	Type	$L0 \times 10^{-12}$ H	$L1 \times 10^{-24}$ H/Hz	$L2 \times 10^{-33}$ H/Hz ²	$L3 \times 10^{-42}$ H/Hz ³		Delay in ps	Z_0 Ω	Loss in G Ω /s	Min	Max		
1	Short ^e						0	50	0	39.873	79.745	WG	Short
2													
3	Short ^e						5.376	50	0	39.873	79.745	WG	$\lambda/4$ Offset
4													
5													
6													
7													
8													
9	Load					Fixed	0	50	0	39.873	79.745	WG	Fixed
10	Load					Sliding	0	50	0	39.873	79.745	WG	Sliding
11	Delay/ thru						0	50	0	39.873	79.745	WG	Thru
12													
13	Undefined												
14	Delay/ thru						0	50	0	39.873	79.745	WG	Thru
15	Delay/ thru						5.378	50	0	39.873	79.745	WG	$\lambda/4$ Delay
16													
17													
18													
19													
20	Load					Offset	5.376	50	0	39.873	79.745	WG	$\lambda/4$ Offset
21													

- a. Ensure system Z_0 of network analyzer is set to this value.
- b. Open, short, load, delay/thru, or arbitrary impedance.
- c. Load or arbitrary impedance only.
- d. For waveguide, the lower frequency is the same as F_{CO} .
- e. Typical values only. Disk values may be different.

Table A-10 Standard Definitions for the 8510 with W-band (WR-10)

Standard ^b		$C0 \times 10^{-15}$ F	$C1 \times 10^{-27}$ F/Hz	$C2 \times 10^{-36}$ F/Hz ²	$C3 \times 10^{-45}$ F/Hz ³	Fixed, Sliding, or Offset ^c	Offset			Frequency in GHz ^d		Coax or Waveguide	Standard Label
Number	Type	$L0 \times 10^{-12}$ H	$L1 \times 10^{-24}$ H/Hz	$L2 \times 10^{-33}$ H/Hz ²	$L3 \times 10^{-42}$ H/Hz ³		Delay in ps	Z_0 Ω	Loss in G Ω /s	Min	Max		
1	Short ^e						0	50	0	59.024	118.05	WG	Short
2													
3	Short ^e						3.620	50	0	59.024	118.05	WG	$\lambda/4$ Offset
4													
5													
6													
7													
8													
9	Load					Fixed	0	50	0	59.024	118.05	WG	Fixed
10	Load					Sliding	0	50	0	59.024	118.05	WG	Sliding
11	Delay/thru						0	50	0	59.024	118.05	WG	Thru
12													
13	Undefined												
14	Delay/thru						0	50	0	59.024	118.05	WG	Thru
15	Delay/thru						3.620	50	0	59.024	118.05	WG	$\lambda/4$ Delay
16													
17													
18													
19													
20	Load					Offset	3.620	50	0	59.024	118.05	WG	$\lambda/4$ Offset
21													

- a. Ensure system Z_0 of network analyzer is set to this value.
- b. Open, short, load, delay/thru, or arbitrary impedance.
- c. Load or arbitrary impedance only.
- d. For waveguide, the lower frequency is the same as F_{CO} .
- e. Typical values only. Disk values may be different.

Table A-11 Standard Definitions for the PNA Series with R-band (WR-28)

System $Z_0^a = 50.0 \Omega$		Calibration Kit Label: R-band											
Standard ^b		$C0 \times 10^{-18} \text{ F}$	$C1 \times 10^{-30} \text{ F/Hz}$	$C2 \times 10^{-39} \text{ F/Hz}^2$	$C3 \times 10^{-48} \text{ F/Hz}^3$	Fixed or sliding	Offset			Frequency in GHz ^c		Coax or Waveguide	Standard Label
Number	Type	$L0 \times 10^{-12} \text{ H}$	$L1 \times 10^{-24} \text{ H/Hz}$	$L2 \times 10^{-33} \text{ H/Hz}^2$	$L3 \times 10^{-45} \text{ H/Hz}^3$		Delay in ps	$Z_0 \Omega$	Loss in GΩ/s	Min	Max		
1	Short/offset	0	0	0	0		10.07	1	0	21.071	42.142	WG	$\lambda/4$ Offset/short
2	Short	0	0	0	0		0	1	0	21.071	42.142	WG	Short
3	Load					Fixed	0	50	0	21.071	42.142	WG	Load
4	Sliding load					Sliding	0	50	0	21.071	42.142	WG	Sliding/Load
5	Offset load					Fixed	10.07	1	0	21.071	42.142	WG	$\lambda/4$ Offset load
6	Delay/thru						0	1	0	21.071	42.142	WG	Thru
7	Delay/thru						0	1	0	21.071	42.142	WG	Thru
8	Delay/thru						10.07	50	0	21.071	42.142	WG	$\lambda/4$ Delay

- a. Ensure system Z_0 of network analyzer is set to this value.
- b. Open, short, load, delay/thru, or arbitrary impedance.
- c. For waveguide, the lower frequency is the same as F_{CO} .

Table A-12 Standard Definitions for the PNA Series with Q-band (WR-22)

System $Z_0^a = 50.0 \Omega$		Calibration Kit Label: Q-band											
Standard ^b		$C0 \times 10^{-18} \text{ F}$	$C1 \times 10^{-30} \text{ F/Hz}$	$C2 \times 10^{-39} \text{ F/Hz}^2$	$C3 \times 10^{-48} \text{ F/Hz}^3$	Fixed or sliding	Offset			Frequency in GHz ^c		Coax or Waveguide	Standard Label
Number	Type	$L0 \times 10^{-12} \text{ H}$	$L1 \times 10^{-24} \text{ H/Hz}$	$L2 \times 10^{-33} \text{ H/Hz}^2$	$L3 \times 10^{-45} \text{ H/Hz}^3$		Delay in ps	$Z_0 \Omega$	Loss in G Ω /s	Min	Max		
1	Short/offset	0	0	0	0		8.082	1	0	26.338	52.676	WG	$\lambda/4$ Offset/short
2	Short	0	0	0	0		0	1	0	26.338	52.676	WG	Short
3	Load					Fixed	0	50	0	26.338	52.676	WG	Load
4	Sliding load					Sliding	0	50	0	26.338	52.676	WG	Sliding load
5	Offset load					Fixed	8.082	1	0	26.338	52.676	WG	$\lambda/4$ Offset/load
6	Delay/thru						0	1	0	26.338	52.676	WG	Thru
7	Delay/thru						0	1	0	26.338	52.676	WG	Thru
8	Delay/thru						8.082	50	0	26.338	52.676	WG	$\lambda/4$ Delay

- a. Ensure system Z_0 of network analyzer is set to this value.
- b. Open, short, load, delay/thru, or arbitrary impedance.
- c. For waveguide, the lower frequency is the same as F_{CO} .

Table A-13 Standard Definitions for the PNA Series with U-band (WR-19)

System $Z_0^a = 50.0 \Omega$		Calibration Kit Label: U-band											
Standard ^b		$C0 \times 10^{-18} \text{ F}$	$C1 \times 10^{-30} \text{ F/Hz}$	$C2 \times 10^{-39} \text{ F/Hz}^2$	$C3 \times 10^{-48} \text{ F/Hz}^3$	Fixed or sliding	Offset			Frequency in GHz ^c		Coax or Waveguide	Standard Label
Number	Type	$L0 \times 10^{-12} \text{ H}$	$L1 \times 10^{-24} \text{ H/Hz}$	$L2 \times 10^{-33} \text{ H/Hz}^2$	$L3 \times 10^{-45} \text{ H/Hz}^3$		Delay in ps	$Z_0 \Omega$	Loss in GΩ/s	Min	Max		
1	Short/offset	0	0	0	0		6.643	1	0	31.386	62.772	WG	$\lambda/4$ Offset/short
2	Short	0	0	0	0		0	1	0	31.386	62.772	WG	Short
3	Load					Fixed	0	50	0	31.386	62.772	WG	Load
4	Sliding load					Sliding	0	50	0	31.386	62.772	WG	Sliding load
5	Offset load					Fixed	6.643	1	0	31.386	62.772	WG	$\lambda/4$ Offset/load
6	Delay/thru						0	1	0	31.386	62.772	WG	Thru
7	Delay/thru						0	1	0	31.386	62.772	WG	Thru
8	Delay/thru						6.643	50	0	31.386	62.772	WG	$\lambda/4$ Delay

- a. Ensure system Z_0 of network analyzer is set to this value.
- b. Open, short, load, delay/thru, or arbitrary impedance.
- c. For waveguide, the lower frequency is the same as F_{CO} .

Table A-14 Standard Definitions for the PNA Series with V-band (WR-15)

System $Z_0^a = 50.0 \Omega$						Calibration Kit Label: V-band							
Standard ^b		$C0 \times 10^{-18} \text{ F}$	$C1 \times 10^{-30} \text{ F/Hz}$	$C2 \times 10^{-39} \text{ F/Hz}^2$	$C3 \times 10^{-48} \text{ F/Hz}^3$	Fixed or sliding	Offset			Frequency in GHz ^c		Coax or Waveguide	Standard Label
Number	Type	$L0 \times 10^{-12} \text{ H}$	$L1 \times 10^{-24} \text{ H/Hz}$	$L2 \times 10^{-33} \text{ H/Hz}^2$	$L3 \times 10^{-45} \text{ H/Hz}^3$		Delay in ps	$Z_0 \Omega$	Loss in G Ω /s	Min	Max		
1	Short/offset	0	0	0	0		5.376	1	0	39.873	79.745	WG	$\lambda/4$ Offset/short
2	Short	0	0	0	0		0	1	0	39.873	79.745	WG	Short
3	Load					Fixed	0	50	0	39.873	79.745	WG	Load
4	Sliding load					Sliding	0	50	0	39.873	79.745	WG	Sliding load
5	Offset load					Fixed	5.376	1	0	39.873	79.745	WG	$\lambda/4$ Offset/load
6	Delay/thru						0	1	0	39.873	79.745	WG	Thru
7	Delay/thru						0	1	0	39.873	79.745	WG	Thru
8	Delay/thru						5.376	50	0	39.873	79.745	WG	$\lambda/4$ Delay

- a. Ensure system Z_0 of network analyzer is set to this value.
- b. Open, short, load, delay/thru, or arbitrary impedance.
- c. For waveguide, the lower frequency is the same as F_{CO} .

Table A-15 Standard Definitions for the PNA Series with W-band (WR-10)

System $Z_0^a = 50.0 \Omega$		Calibration Kit Label: W-band											
Standard ^b		$C0 \times 10^{-18} \text{ F}$	$C1 \times 10^{-30} \text{ F/Hz}$	$C2 \times 10^{-39} \text{ F/Hz}^2$	$C3 \times 10^{-48} \text{ F/Hz}^3$	Fixed or sliding	Offset			Frequency in GHz ^c		Coax or Waveguide	Standard Label
Number	Type	$L0 \times 10^{-12} \text{ H}$	$L1 \times 10^{-24} \text{ H/Hz}$	$L2 \times 10^{-33} \text{ H/Hz}^2$	$L3 \times 10^{-45} \text{ H/Hz}^3$		Delay in ps	$Z_0 \Omega$	Loss in G Ω /s	Min	Max		
1	Short/offset	0	0	0	0		3.62	1	0	59.024	118.05	WG	$\lambda/4$ Offset/short
2	Short	0	0	0	0		0	1	0	59.024	118.05	WG	Short
3	Load					Fixed	0	50	0	59.024	118.05	WG	Load
4	Sliding load					Sliding	0	50	0	59.024	118.05	WG	Sliding load
5	Offset load					Fixed	3.62	1	0	59.024	118.05	WG	$\lambda/4$ Offset/load
6	Delay/thru						0	1	0	59.024	118.05	WG	Thru
7	Delay/thru						0	1	0	59.024	118.05	WG	Thru
8	Delay/thru						3.62	50	0	59.024	118.05	WG	$\lambda/4$ Delay

- a. Ensure system Z_0 of network analyzer is set to this value.
- b. Open, short, load, delay/thru, or arbitrary impedance.
- c. For waveguide, the lower frequency is the same as F_{CO} .

Blank Forms

The standard definitions may be changed to meet your specific requirements. The following two tables are provided to record the modified standard definitions.

Table A-16 Blank Form for the 8510 Network Analyzer

System $Z_0^a =$ _____ Calibration Kit Label: _____														
Disk File Name: _____														
Number	Standard ^b Type	$C0 \times 10^{-15}$ F	$C1 \times 10^{-27}$ F/Hz	$C2 \times 10^{-36}$ F/Hz ²	$C3 \times 10^{-45}$ F/Hz ³	Fixed, Sliding, or Offset ^c	Offset			Frequency in GHz ^d		Coax or Waveguide	Standard Label	
		$L0 \times 10^{-12}$ H	$L1 \times 10^{-24}$ H/Hz	$L2 \times 10^{-33}$ H/Hz ²	$L3 \times 10^{-42}$ H/Hz ³		Delay in ps	$Z_0 \Omega$	Loss in GΩ/s	Min	Max			
1														
2														
3														
4														
5														
6														
7														
8														
9														
10														
11														
12														
13														
14														
15														
16														
17														
18														
19														
20														
21														

- a. Ensure system Z_0 of network analyzer is set to this value.
- b. Open, short, load, delay/thru, or arbitrary impedance.
- c. Load or arbitrary impedance only.
- d. For waveguide, the lower frequency is the same as F_{CO} .

Table A-17 Blank Form for the PNA Series Network Analyzer

System $Z_0^a =$ _____		Calibration Kit Label: _____											
Number	Type	Standard ^b				Fixed or sliding	Offset			Frequency in GHz ^c		Coax or Waveguide	Standard Label
		$C0 \times 10^{-18}$ F	$C1 \times 10^{-30}$ F/Hz	$C2 \times 10^{-39}$ F/Hz ²	$C3 \times 10^{-48}$ F/Hz ³		Delay in ps	$Z_0 \Omega$	Loss in GΩ/s	Min	Max		
1		$L0 \times 10^{-12}$ H	$L1 \times 10^{-24}$ H/Hz	$L2 \times 10^{-33}$ H/Hz ²	$L3 \times 10^{-45}$ H/Hz ³								
2													
3													
4													
5													
6													
7													
8													

- a. Ensure system Z_0 of network analyzer is set to this value.
- b. Open, short, load, delay/thru, or arbitrary impedance.
- c. For waveguide, the lower frequency is the same as F_{CO} .

Index

A

Agilent Technologies
 contacting, 6-4
 warranty, ii
alcohol
 isopropyl
 part number, 7-14
 precautions for use of, 4-3
aligning
 non-precision and precision
 flanges, 4-6
 precision flanges, 4-5
altitude, specifications, 2-2
analyzers, compatible, 1-2
assistance
 contacting agilent, 6-4

B

blank forms
 standard class assignments, A-5
 standard definitions, A-18
box, part number, 7-4, 7-6, 7-8,
 7-10, 7-12

C

cal kit
 contents, 1-2
 misuse of, ii
 overview, 1-2
 verifying, 5-2
calibration
 bad, 6-2
 certificate of, 5-3
 constants, A-7
 definitions
 disk, part number, 7-6, 7-8,
 7-10
 part number, 7-12
 devices, 3-2
 kits, intended use, 1-3
 report, 5-3
 residual errors, 2-3
 standards, 5-2
 sticker, 5-3
 temperature, 2-2
calibration applications, 3-3
 1/4 load, 3-4
 1/4 short, 3-5
 isolation, 3-3
 line, 3-3
 load, 3-4
 offset load, 3-4
 offset short, 3-5
 reflect, 3-5
 short, 3-5
 thru, 3-6

calibration definition, wavelength
 shim, 3-7
calibration kit
 contents, 1-2
 drawing of, 7-5, 7-7, 7-9, 7-11,
 7-13
 misuse of, ii
 overview, 1-2
 parts not included, 7-14
 performance
 how Agilent verifies, 5-2
 warranty, ii
case, storage, 7-4, 7-6, 7-8, 7-10,
 7-12
certificate of calibration, 5-3
certification, device specifications,
 2-3
characteristics
 mechanical, 2-3
class assignments
 blank forms, A-5
class assignments, standard, A-2,
 A-3, A-5
cleaning
 connectors, 4-3
 mating plane surfaces, 4-3
 supplies, 1-3
 part number, 7-14
compatible analyzers, 1-2
component identification sheets
 Q and U-band, 7-7, 7-9
 R-band, 7-5
 V and W-band, 7-11, 7-13
compressed air
 for cleaning, 4-3
conductive table mat, part
 number, 7-14
connecting
 flanges, 4-4, 4-7
 for ESD protection, 4-2, 7-14
 waveguides, 4-4
connections, 4-4
connector
 cleaning, 4-3
 mating plane surfaces, 4-3
constants, A-7
 part numbers, 7-4, 7-8, 7-12
contacting Agilent Technologies,
 6-4
contents
 calibration kit, 1-2
 drawing of, 7-5, 7-7, 7-9, 7-11,
 7-13
 incomplete, 1-3

D

damage

 caused by electrostatic
 discharge, 4-2
data, recertification, 5-3
definitions
 calibration, 3-7
 standard, A-7, A-8, A-9, A-10,
 A-11, A-12, A-13, A-14,
 A-15, A-16, A-17
deviation from nominal phase, 2-3
device
 calibration, 3-2
 cleaning, 4-3
 compatible analyzers, 1-2
 connecting, 4-4
 handling, 4-8
 maintenance, 1-5
 performance, verifying, 5-2
 specifications
 certification of, 2-3
 electrical, 2-3
 traceability, 5-2, 5-3
 storage, 4-8
 temperature, 2-2
 visual inspection, 4-2
disk
 calibration definitions
 part number, 7-4, 7-6, 7-8,
 7-10, 7-12
 specifications and performance
 part number, 7-4, 7-6, 7-8,
 7-10, 7-12
documented kits, 1-3

E

electrical
 characteristics
 effects of temperature, 2-2
 specifications, 2-3
electrostatic discharge, *See* ESD
environmental
 regulations, 4-3
 requirements, 2-2
 specifications, 2-2
equipment required, 1-3
ESD, 4-2
 protection, 4-2
 supplies, part number, 7-14

F

flange, connect, 4-7
flowchart, troubleshooting, 6-2
frequency specification, 2-3

G

general information, 1-1

Index

grounding cord, part number, 7-14

H

handling, 4-8
heel strap, part number, 7-14
history, serial numbers, 1-3
humidity specifications, 2-2

I

impedance, system, A-7
incoming inspection, 1-3
information, troubleshooting, 6-4
inspection
 flange connection, 4-7
 incoming, 1-3
 visual, 4-2
isolation, 3-3
isopropyl alcohol
 part number, 7-14
 precautions for use of, 4-3

K

kit
 contents, 1-2, 7-4, 7-8, 7-12
 drawing of, 7-5, 7-7, 7-9, 7-11, 7-13
 overview, 1-2
 performance
 failure, 6-2
 verification, 5-2
 warranty, ii

L

line, 3-3
load, 3-4
load, part numbers, 7-4

M

maintenance
 of devices, 1-5
 preventive, 1-5
manual
 part number, 7-4, 7-8, 7-12
mat
 conductive
 part number, 7-14
 for ESD protection, 4-2
mating plane surfaces
 cleaning, 4-3
 connector, 4-3
mechanical characteristics, 2-3
MIL-STD 45662
 calibration, 5-3

N

National Institute of Standards and Technology (NIST), 2-3, 5-2
network analyzers, compatible, 1-2
nitrogen, for cleaning, 4-3
nominal standard definitions, A-7
non-precision flanges, aligning, 4-6
numbers
 replaceable parts, 7-3, 7-4, 7-8, 7-12, 7-14
 serial, 1-4

O

offset load, 3-4
offset short, 3-5
ordering, parts, 7-3, 7-14
oxygen, 4-3

P

part numbers, 7-3
 included in kit, 7-4, 7-12
 not included in kit, 7-8
 of items not in kit, 7-14
performance
 and specifications disk, 7-6, 7-8, 7-10, 7-12
 verification, 5-2, 6-2
performance test, 5-4, 5-5
port 1 and 2, 3-2
precision flanges, 4-4, 4-5, 4-6
preventive maintenance, 1-5
procedures
 aligning flanges, 4-5
 cleaning, 4-3
 tightening flanges, 4-7

R

recertification
 how often, 5-3
 services included, 5-3
record serial number, 1-4
reflect, 3-5
regulations
 environmental, 2-2, 4-3
replaceable parts, 7-3, 7-14
 drawing of, 7-5, 7-7, 7-9, 7-11, 7-13
 Q11644A WR-22, 7-8
 R11644A WR-28, 7-4
 U11644A WR-19, 7-8
 V11644A WR-15, 7-12
report, calibration, 5-3
required equipment, 1-3

requirements, environmental, 2-2
residual errors, 2-3
return kit or device to Agilent, 1-3, 6-4
return loss specification, 2-3

S

serial numbers, 1-4
 devices, 1-4
 history, 1-3
 recording, 1-4
service, 6-4
service tag, 5-3, 6-4
shim, 3-2
short, 3-5
 part numbers, 7-4, 7-6, 7-8, 7-10, 7-12
specifications, 2-2
 altitude
 operating, 2-2
 storage, 2-2
 and performance disk
 part number, 7-6, 7-8, 7-10, 7-12
 certification of, 2-3
 characteristics, 2-3
 deviation from nominal phase, 2-3
 device, 2-3
 electrical, 2-3
 environmental, 2-2
 frequency, 2-3
 operating, 2-2
 return loss, 2-3
 storage, 2-2
 temperature, 2-2
 traceability, 5-2, 5-3
standard class assignments, A-2
 8510, A-2, A-3, A-5
 blank forms, A-5
standard definitions, A-7, A-18
 blank forms, A-18
 nominal, A-7
PNA series, A-13, A-14, A-15, A-16, A-17
Q-band (WR-22), A-9, A-14
R-band (WR-28), A-8, A-13, A-14
U-band (WR-19), A-10, A-15, A-16, A-17
V-band (WR-15), A-11, A-16, A-17
W-band (WR-10), A-12, A-17
standard section, 3-2
standards
 international, 2-3

Index

National Institute of Standards and Technology (NIST), [2-3](#), [5-2](#)
static electricity, [4-2](#)
storage, [4-8](#)
storage case, part number, [7-4](#), [7-6](#), [7-8](#), [7-10](#), [7-12](#)
strap
 heel and wrist, part number, [7-14](#)
supplies
 cleaning, [1-3](#)
 part number, [7-14](#)
system impedance, [A-7](#)

T

table mat
 for ESD protection, [4-2](#)
 part number, [7-14](#)
tag, service, [5-3](#), [6-4](#)
temperature
 affect on electrical performance, [2-2](#)
 cautions about, [2-2](#)
 environmental requirements, [2-2](#)
 error-corrected, [2-2](#)
 measurement, [2-2](#)
 specifications, [2-2](#)
 verification and measurement, [2-2](#)
termination, [3-2](#)
test data, [5-3](#)
test, performance, [5-4](#), [5-5](#)
thru, [3-6](#)
traceability
 of device specifications, [5-2](#), [5-3](#)
troubleshooting, flowchart, [6-2](#)

U

user's and service guide
 part number, [7-6](#), [7-8](#), [7-10](#), [7-12](#)

V

verification
 device, [5-2](#)
 performance, [5-3](#)
 temperature, [2-2](#)
version changes, system
 impedance, [A-7](#)
visual inspection, [4-2](#)

W

warranty, [ii](#)
waveguide straight

 port 1 and 2, [3-2](#)
 verification device, [3-2](#)
waveguide, connecting, [4-4](#)
wavelength shim, [3-2](#)
wavelength shim, calibration
 definition, [3-7](#)
wrist strap
 for ESD protection, [4-2](#)
 part number, [7-14](#)