

Optical Spectrum Analyzer AQ-6315A/-6315B



The Next Standard

The AQ-6515A/-6315B optical spectrum analyzer brings advanced capabilities to a wide range of applications, from light source evaluation to measurement of loss wavelength characteristics in optical devices. Featuring significant upgrades from the basic performance and functions of the prior AQ-6312A/-6312B models, they incorporate a totally new monochromator design. In spite of the compact case, they support single-pass/double-pass monochromator mode select. In the double-pass monochromator mode dynamic range is improved far beyond what it has even been before. In the single-pass monochromator mode it supports the same wide range of applications as the prior models. The AQ-6315A/-6315B, bringing the full selection of advanced Ando spectrum analyzer technology to your work.... a new standard for the industry.

This equipment is available in two specification depending on the presence of the optical function

MODEL	OPTICAL OUTPUT FUNCTION
AQ-6315A	NO
AQ-6315B	YES

MAJOR FEATURES

Diverse analysis functions Analysis functions for WDM and other optical devices (LD, LED, FBG, etc.).

High wavelength accuracy Provides ± 0.05 nm wavelength accuracy in the 1550 nm band, with ± 0.02 nm wavelength linearity, makes it especially useful for WDM devices, such as high-precision loss wavelength characteristic evaluation.

Monochromator select mode The monochromator mode can be set to single-pass or double-pass to match your measurement application needs.

High sensitivity over a wide band Covers from 350nm to 1750nm and noise level has been suppressed to allow the AQ-6315A/-6315B to measure light at down to -90 dBm

Low polarization dependency Polarization dependency has been slashed to ± 0.05 dB, enabling accurate measurement of optical amplifier gain and other critical measurements.

High-level accuracy Accurate to within ± 0.3 dB.

High-power measurement: Max.+20dBm (100mW) Even high power output from an optical amplifier can be measured directly without an optical attenuator

High wavelength resolution Achieves wavelength resolution of 0.05nm.

Optical output is provided (AQ6315B only) Can be used as an optical bandpass filter.

Three individual trace memories

Pulsed light can be measured

9.4-inch color LCD

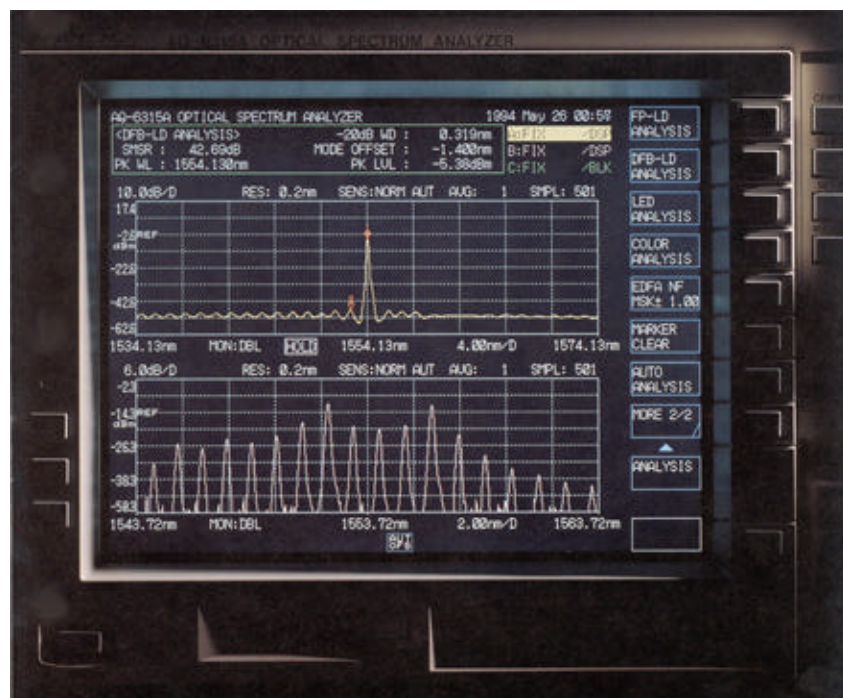

Manual-Free Operation

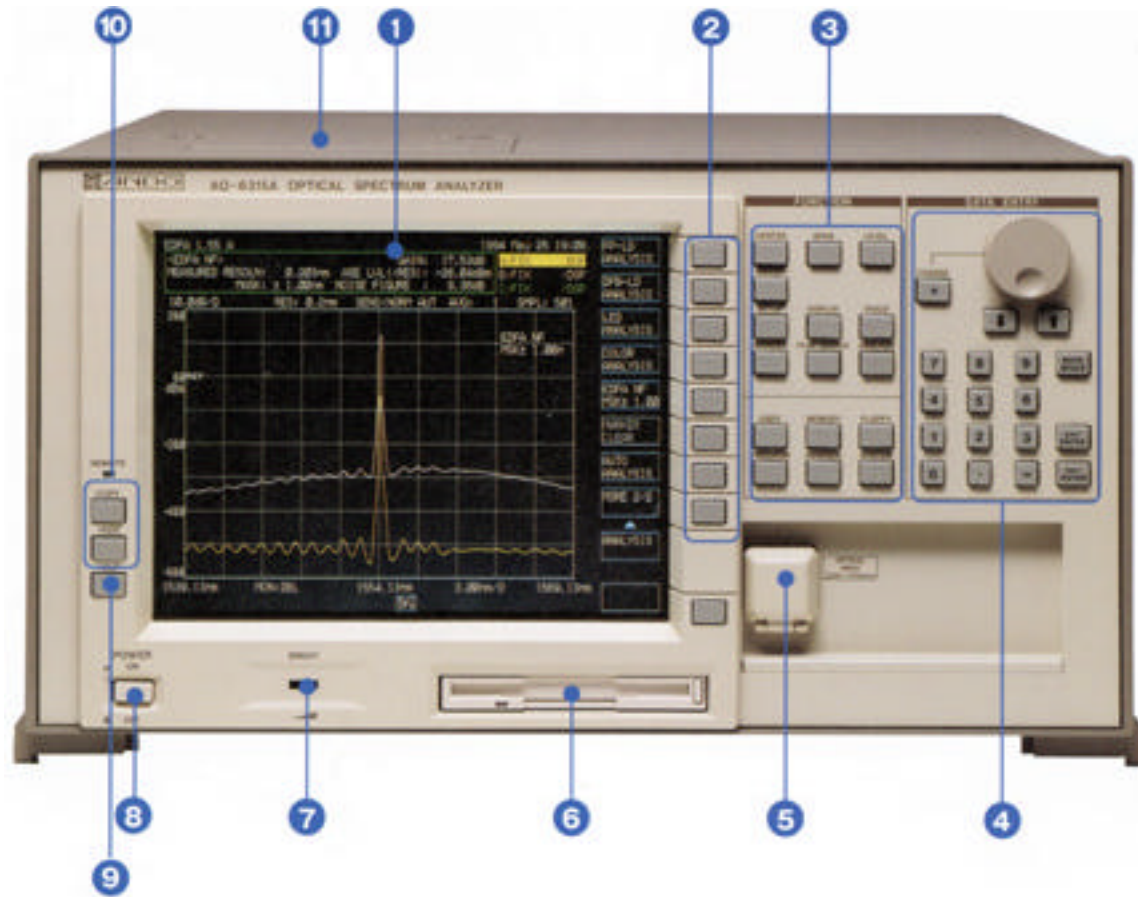

1-9.4-inch color liquid crystal display Displays all information such as measurement waveforms, measurement conditions and measured data.

2-Function keys and window menus Used to select and execute various measurement conditions, corresponding to main functions switches.

3-Main function select switch All measurement settings

4-Data entry selection Used to input data, such as rotary knob, step key and ten-key pad.

5-Optical input connector

6-3.5-inch floppy disk drive Supports both 1.2MB and 1.44MB disks. Data can be saved on both text file and graphic file (BMP, TIFF) formats.

7-Intensity Adjust the display intensity.

8-Power switch

9-Help key Used to verify the actions of various function keys.

10-Used to output data to the internal printer and external plotter.

11-Internal printer Used to quickly output screen hard copies.

Application

WDM device characteristics evaluation

This system calculates key data such as peak wavelength, frequency separation, peak level and SNR for each channel for up to 99 channels, based on the WDM transmission optical spectrum. SNR is the difference between level and noise level for each channel peak.

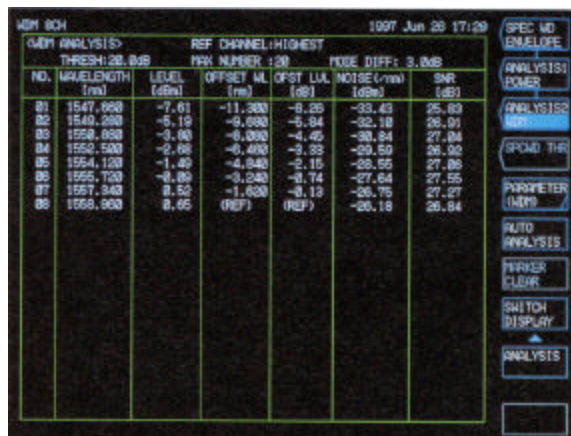
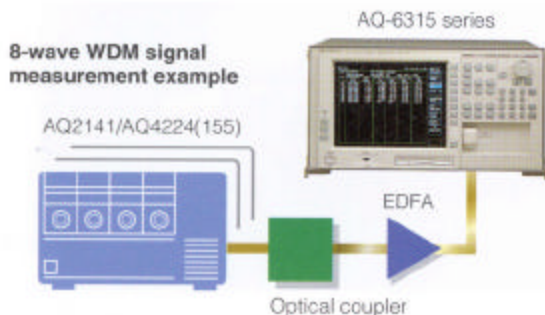

Optical fiber amplifier (EDFA) characteristic evaluation

The ASE interpolation method is used to measure gain and NF, key parameters for optical fiber amplifier evaluation. When used with the AQ8423A/8423B optical amplifier analyzer, the system can accurately measure gain and NF with the pulse method, which is optimum for evaluation of WDM transmission optical fiber amplifiers.

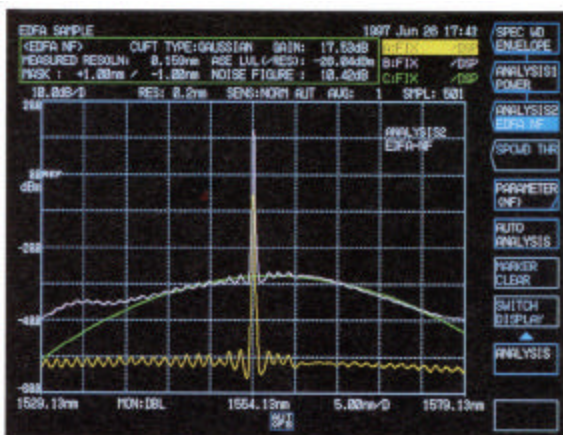
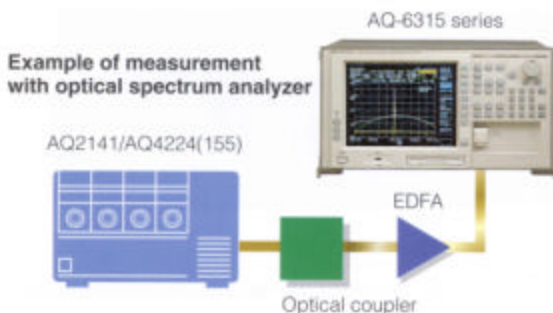

Example of measurement in combination with optical amplifier analyzer

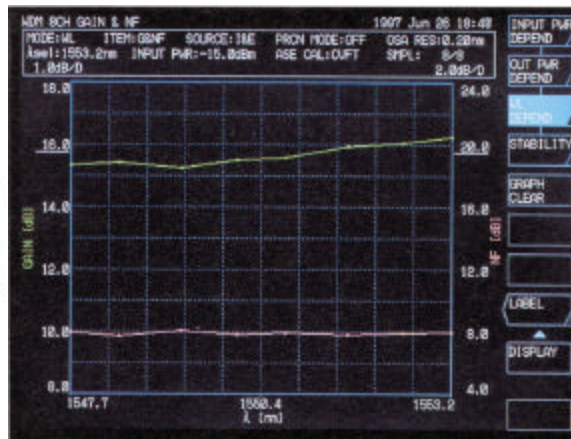
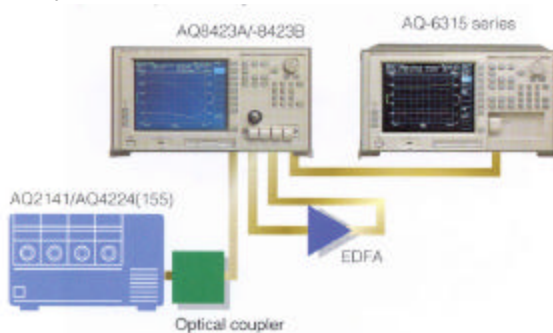

Application

Parameter evaluation for LED, FP-LD and FB-LD. One-touch evaluation of key parameters for LED, FP-LD and DFB-LD such as side mode suppression ratio for DFB-LD.

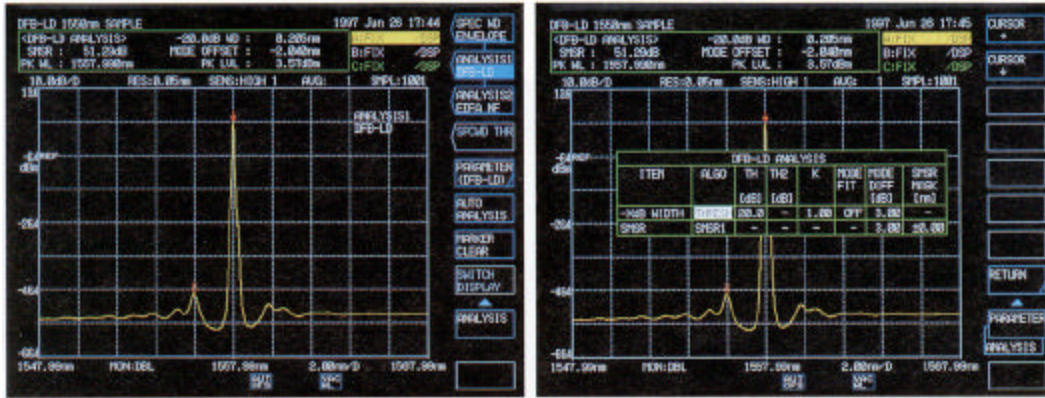

Color analysis color analysis for color PDP, color LCD, color CRT, and visible LED and LD. The spectral diagram can also be displayed

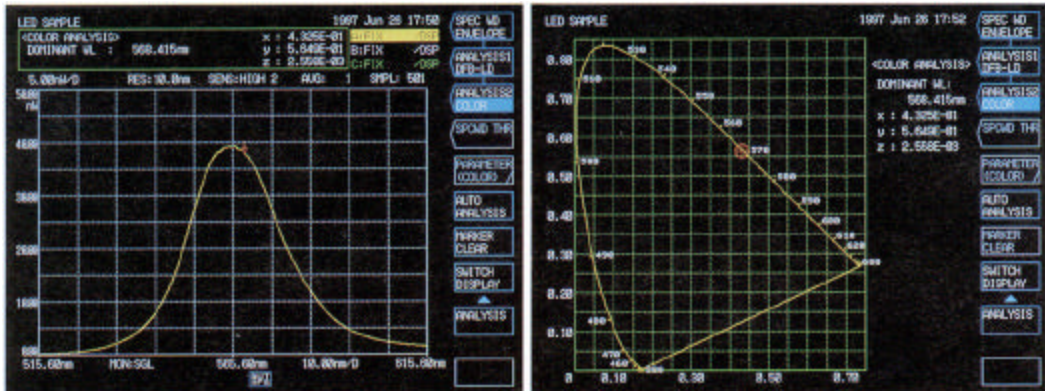

Pulse light measurement

Offers three pulse light measurement functions (LPF, peak hold, external trigger). Select the appropriate mode for your repeating frequency.

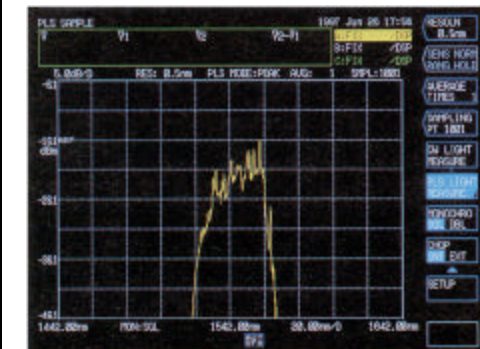

Wide-region optical device evaluation

The level axis can be set to dBm/nm (power density: Power per nm) to display true wide-region light source level, independent of resolution.

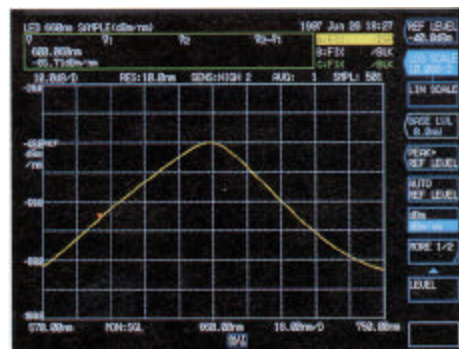

Application

Fiber grating characteristics evaluation

When used in combination with the AQ2141 expansion frame and the AQ4310 (155) ASE unit. It is possible to evaluate performance such as notch width for fiber grating transmission spectrums.

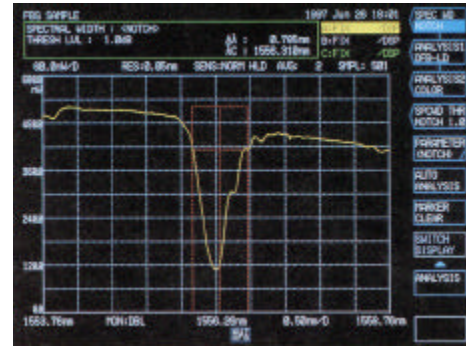
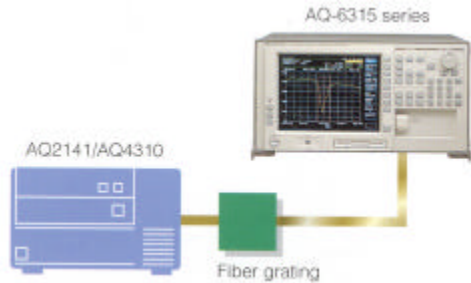

Optical filter loss evaluation

When used in combination with the AQ4303B white light source and the AQ9314B parallel beam mount, it is possible to evaluate transmission characteristics of optical filters. (% Display)

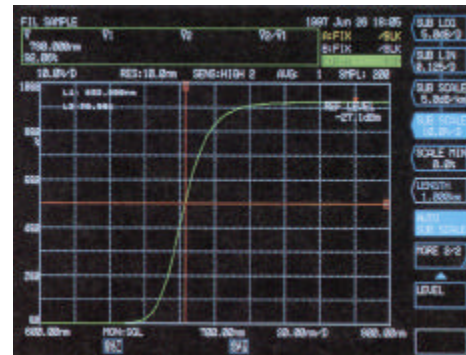
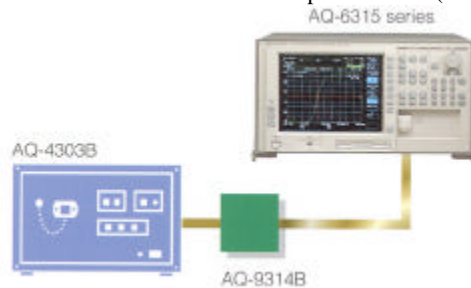

Optical fiber loss wavelength characteristics

When used in combination with the AQ4303B white light source, it is possible to evaluate optical fiber loss-wavelength characteristics. Also the arithmetic function can convert optical fiber loss wavelength characteristics into loss per unit length for display.

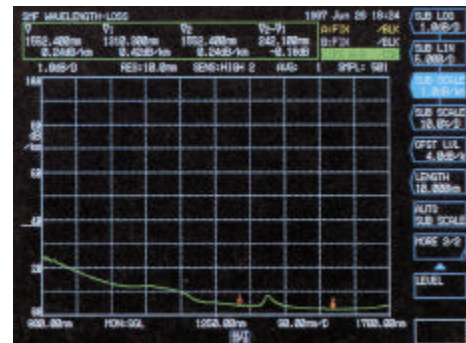
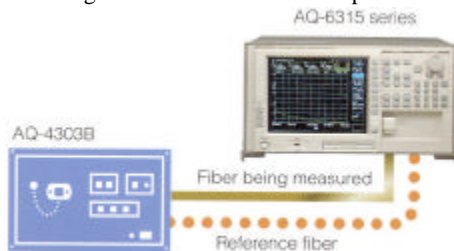

Specifications

		Single-pass monochromator mode	Double-pass monochromator mode
Applicable fiber		SM to 800 μ m diameter fiber	SM, GI (50/62.5 μ m)
Measurement wavelength range		350 to 1750nm	
Wavelength span		0 to 1500nm	
Wavelength accuracy		± 0.5 nm (25 \pm 5 $^{\circ}$ C, 10/125 SM fiber) ± 0.05 nm (1510 to 1570nm, 10/125 SM fiber)	
Wavelength linearity		± 0.02 nm (1510 to 1570nm, 10/125 SM fiber)[1]	
Wavelength reproducibility		± 0.005 nm (1 minute)	
Wavelength resolution		0.05 to 10nm	
Measurement level range [2]		-90 to +20dBm (1000 to 1600nm) -85 to +20dBm (600 to 1000nm) -75 to +20dBm (350 to 1750nm)	-85 to +20dBm (1200 to 1600nm) -80 to 20dBm (600 to 1200nm) -65 to +20dBm (350 to 1750nm)
Level accuracy [3]		± 0.3 dB (at 633/1310/1550nm)	
Polarization dependency [4]		± 0.1 dB (at 1310/1550nm)	± 0.05 dB (at 1310/1550nm)
Linearity [5]		± 0.05 dB (0 to -40dBm), ± 0.2 dN (0 to -60dBm)	
Level scale		0.1 to 10dB/div. And linear	
Dynamic range (stray light level) [6]		40dB (± 1 nm, 633/1152/1523nm) 35dB (± 0.5 nm, 633/1152/1523nm)	70dB (± 1 nm, 633/1152/1523nm) 60dB (± 0.5 nm, 633/1152/1523nm)
Sweep time [7]		0.5 s. or less (span 500nm or less) 2.5 s. or less (full span)	
Functions	Measurement	Automatic measurement, marker-to-marker sweep measurement, averaging, pulsed light measurement function. Power meter function	
	Display	3D display, split (dual) display	
	Individual 3 trace memories	Max./min. hold, data calculation (addition, subtraction, division), normalize, Dominant, curve-fit display, power density display function, dBm/km, % level scale	
	Data analysis	Peak/bottom searches, spectral width search, SMSR search. Marker to marker power measurement function, optical amplifier NF measurement function, color analysis function, WDM analysis function, notch width measurement function	
Other		Program function (200 steps \times 20 programs), wavelength calibration function, calendar/date function, help function, user key define function, label function	
Optical output [8]		Resolution setting range: 0.05 to 10nm Insertion loss: 20dB or less (1310/1550nm) Optical fiber: GI 50/125 μ m	
Memory	FDD	Traces, analysis data and programs on 3.5-inch FD (1.2/1.44Mbyte)	
	Internal memory	Traces and measurement conditions (32 traces), 20 programs	
Data Output	Printer	High-speed built-in printer	
	Plotter	Direct output to XY plotter	
Interfaces	GP-IB	2 ports	
	Other	Sweep trigger input (TTL), sample trigger input (TTL), sample trigger output (TTL) Sample enable input (TTL), 270Hz output (TTL), analog output (0-5V), Video output (VGA compatible)	
Display		9.4-inch color LCD, resolution 640 \times 480 dots	
Optical input connector		FC (standard) SC, D4, W/E, ST, DIN, etc.	
Power requirements		AC100V to 120V, 200V to 240V, 48 to 83Hz, approx. 200VA	
Environment		Operating temperatures: 5 $^{\circ}$ C to 40 $^{\circ}$ C Storage temperatures: -10 $^{\circ}$ C to 50 $^{\circ}$ C Humidity: 80% or less (no condensation)	
Dimensions and mass		Approx. 425 (W) \times 222 (H) \times 450 (W) mm, approx. 30kg	
Accessories		Power cord: 1ea, 3.5-inch FD: 2ea, recording paper: 2ea, instruction manual: 1ea	

Note that device adapters, quartz cells for liquid measurement, parallel beam mounts, and white light sources are optional. Please consult with your vendor separately.

*These specifications are for products delivered later than October 1997

NOTE:

[1] After power-on and more than two hours of warm-up, within 24 hours from wavelength calibration with 1523nm HE-NE laser.

[2] At 25 \pm 5 $^{\circ}$ C. Resolution 0.5nm or more.

[3] 10/125 SM fiber, 25 \pm 5 $^{\circ}$ C, input level -30dBm or more

[4] 10/125 SM fiber, 25 \pm 5 $^{\circ}$ C, resolution 0.5nm or more

[5] 25 \pm 5 $^{\circ}$ C, sensitivity HIGH 3.

[6] 10/125 SM fiber, 25 \pm 5 $^{\circ}$ C, resolution 0.05nm, excluding high-order and low-order harmonics

[7] Single-trace display, sampling points: 501, sensitivity NORMAL HOLD. Average time: 1, no changes of diffraction order within sweep range except the full span

[8] AQ6315B only

Specifications are subject to change without notice.