

# MP1570A

## SONET/SDH/PDH/ATM Analyzer SDH Edition



*High Performance and Portable for SONET, SDH, PDH, and ATM Networks*

# Analyzer Conforming to Bit Rates from 1.5 Mbps to 10 Gbps

The MP1570A is an analyzer designed for the manufacturing, construction, maintenance, and inspection of SONET, SDH, PDH, and ATM equipment and networks. Various plug-in units available for the MP1570A allow the user to construct various analysis systems for different applications.

The MP1570A has six slots to connect the plug-in units required for SDH and SONET tests at bit rates from 1.5 Mbps to 10 Gbps. Also ATM, jitter, and wander tests can be done by appropriate combinations of plug-in units. The MP1570A conforms to the ITU-T and Bellcore standards and supports concatenation mapping, tandem connection, APS measurement, and CID measurement. The user can measure 10 Gbps signals using a single MP1570A; conventionally, this required multiple pieces of measurement equipment.

The MP1570A has a printer and a 3.5-inch floppy disk drive as standard output devices. The user can print the measurement results, save and read data to and from a floppy disk, and read measurement data on an external personal computer. The user can also save screen data to a floppy disk. The MP1570A has a function to help the user understand the analyzer operations and functions and the connection methods.

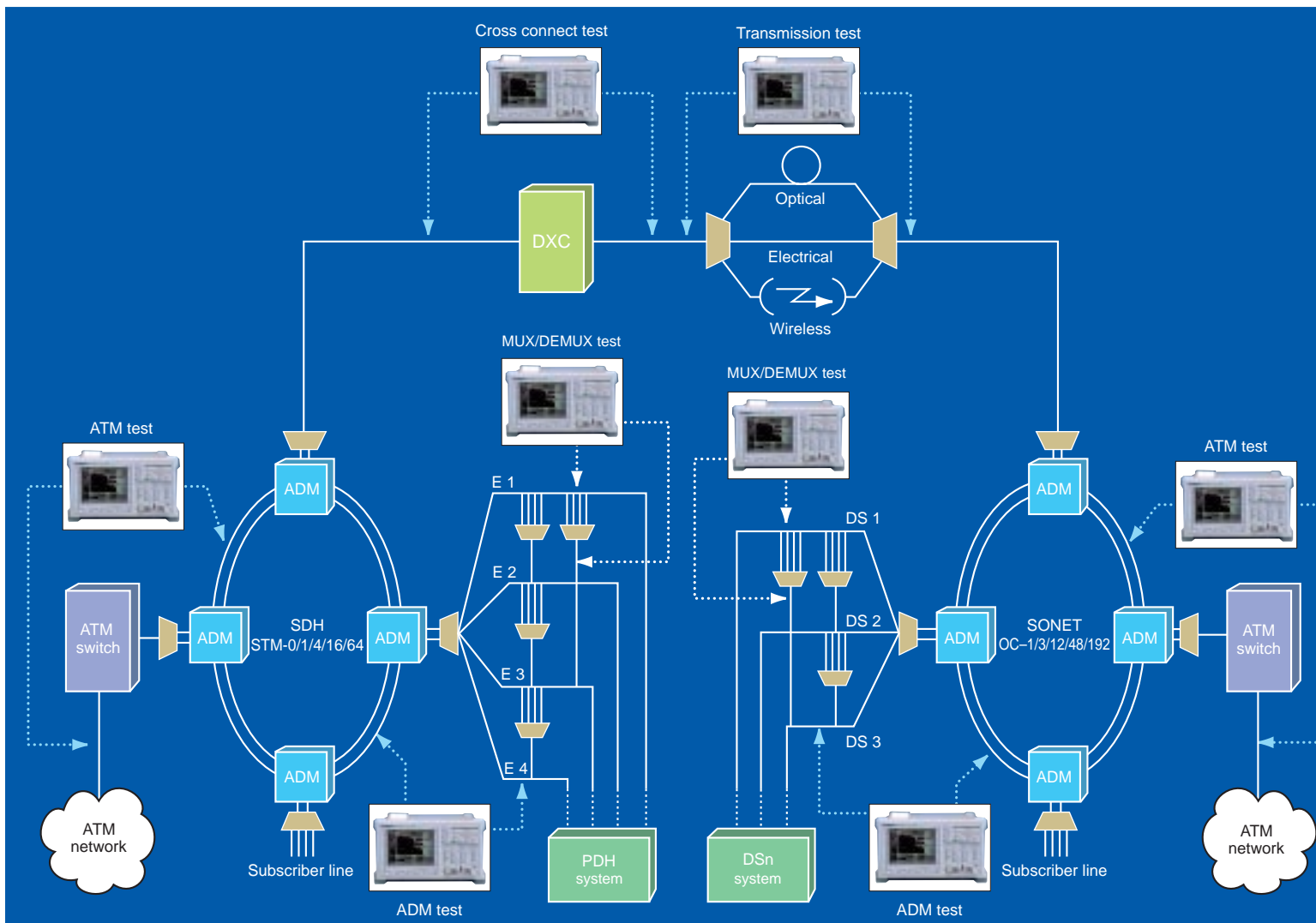

- **Conforming to bit rates from 1.5Mbps to 10 Gbps with a single unit**

The MP1570A conforms to ITU-T Recommendations G.703 (2, 8, 34, 139, 1.5, and 45 Mbps) and G.703 and G.958 (52, 156, 622, 2,488, and 9,953 Mbps), allowing the user to select plug-in units for different applications, including SDH, ATM, and jitter tests.

- **Concatenation mapping**

The MP1570A can perform SDH and SONET tests through the mapping routes from STM-1C to STM-64C.

- **Enhanced SDH and SONET test functions**

The MP1570A supports the generation and detection of CID patterns (ITU-T Recommendation G.958), tandem connection patterns (ITU-T Recommendation G.707), and no-frame patterns and the setting and resetting of conditions for an APS switch time test (ITU-T Recommendations G.707, G.783, and G.842), overhead test, and alarm detection.

- **Frame memory and capture (optional)**

The MP1570A can be used to edit and analyze up to 64 frames of data (or up to 26 frames of data at 10 Gbps).

- **Enhanced through-modes**

The MP1570A allows the user to select one of four through modes: transparent through, overhead/over-write, payload/overwrite, and add/drop. The user can also insert various kinds of error and alarm signals into through signals.

- **Error analysis (error performance)**

The MP1570A enables the user to perform measurement conforming to ITU-T Recommendations G.821, M.2100, G.826, M.2101, M.2110, and M.2120.

- **Frequency and optical power measurement**

The MP1570A can measure received frequencies and display measurement results in a graph. If an optical interface plug-in unit is installed, the MP1570A can measure the absolute and relative values of optical power.

- **Jitter generation and measurement**

The MP1570A can measure jitter tolerance and jitter transfer characteristics in conformance with ITU-T Recommendations G.823, G.824, G.825, and G.958 and Bellcore 253 and 499. It displays measurement results as numeric values and in a graph, allowing the user to evaluate them easily.

- **Wander generation**

The MP1570A can generate wander signals in conformance with ITU-T Recommendations G.823, G.824, and G.825 and Bellcore 253 and 499. If a separately sold application program is installed on the external personal computer connected, evaluation of MTIE and TDEV is possible.

- **ATM pattern generation and measurement**

The MP1570A can not only test cell performance but also measure cell delay time, CDV, and cell traffic. For OAM testing, it can generate and detect the AIS, RDI, and continuity check cells for F4 and F5 flows. It can also generate the loopback and performance-monitoring cells which conform to ITU-T Recommendation I.610.

- **Supporting SDH, SONET, and Japan modes with one cabinet (optional)**

The MP1570A allows the user to set up the measurement of SDH, SONET, 384k, and Japan mapping with one cabinet. For Japanese mapping measurement, the user can set a signaling pattern (multi-frame pattern of 8 frames or 64 frames).

# SONET, SDH, and PDH Measurement

## Measurement at bit rates from 1.5 Mbps to 10 Gbps

The user can set a mapping route with a bit rate of up to 10 Gbps. The MP1570A mainly supports SDH, SONET, and Japanese mapping for digital communication. A route from STM-1C to up to STM-64C can be set for concatenation mapping. Furthermore, the MP1570A supports a combination of channels -- for example, one channel of VC4, 16 channels of STM4C, and four channels of STM16C. (See fig.1/P.10)

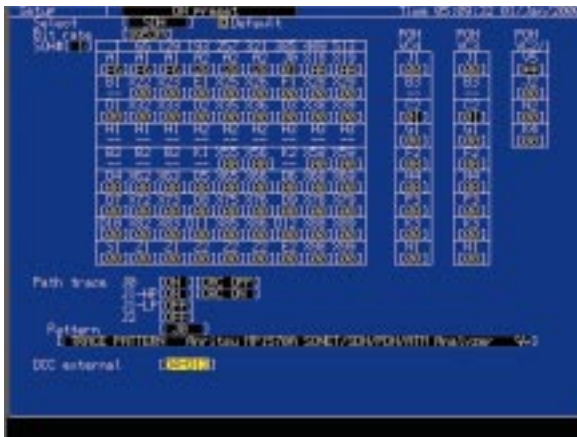
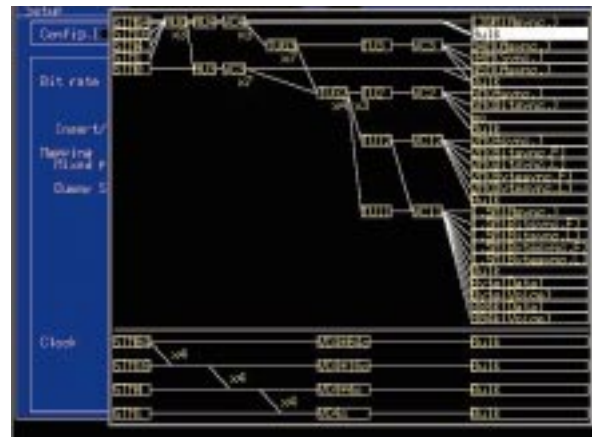

## Overhead setting and testing

The user can set overhead, modify the capture and overhead settings, and measure pointer 64 frames and overhead bit errors.

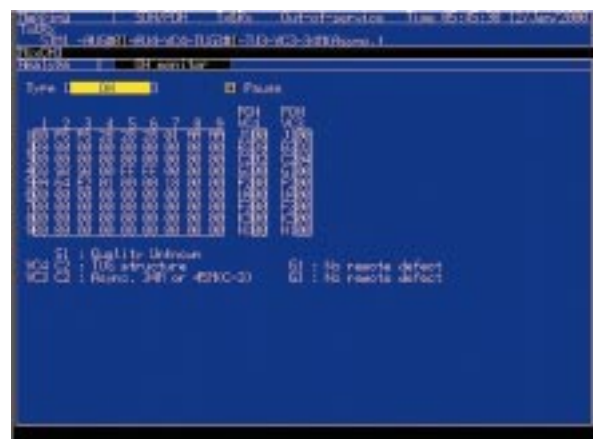



## APS function

The user can test the automatic protection switch (APS) by measuring the equipment switching time accurately in units of milliseconds. The MP1570A also conforms to ITU-T Recommendations G.783 and G.841.

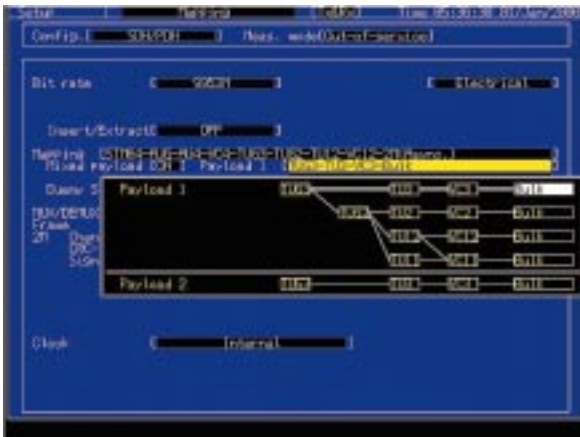
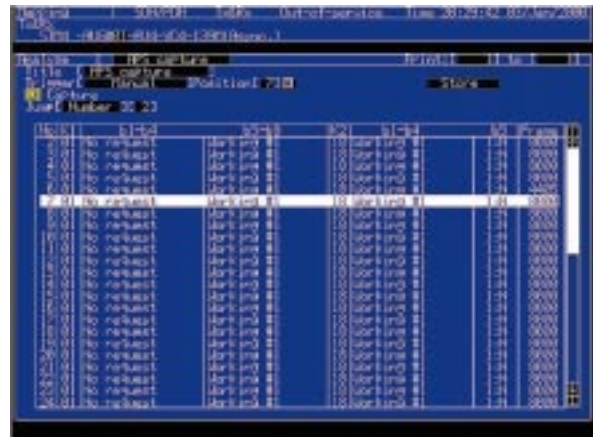
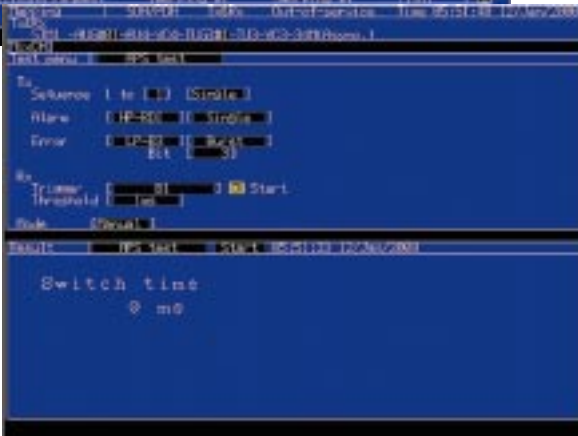

## Tandem connection

The user can set and measure N1 and N2 bytes.

## Mixed payload

At measurement of mapping in TUG-3 and lower-level layers, the user can set two additional channels other than the measurement-target channels.



## Various analysis functions

The MP1570A has an internal optical power meter which allows the user to measure optical power during error and alarm measurement without changing the connections of the optical fiber cables. (Photo A)

The MP1570A can capture an arbitrary SOH or POH (1 byte), K1 or K2 byte, or H1 or H2 byte in 1,024 frames for analyzing errors and alarms and for checking APS operation. (Photo B)

Measured errors and alarms can be displayed in a graph. The user can select a unit time of 1 second, 1 minute, 15 minutes, or 60 minutes for a bar graph. (Photo C)



Photo A

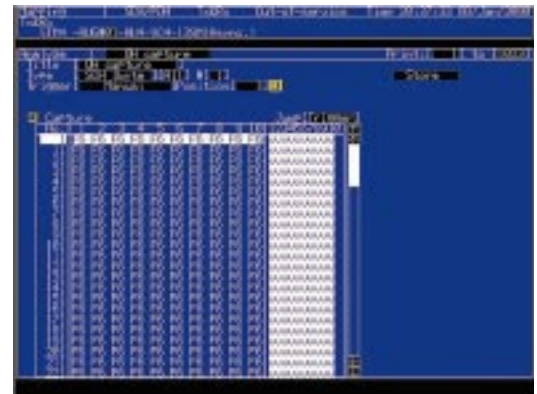

Photo B

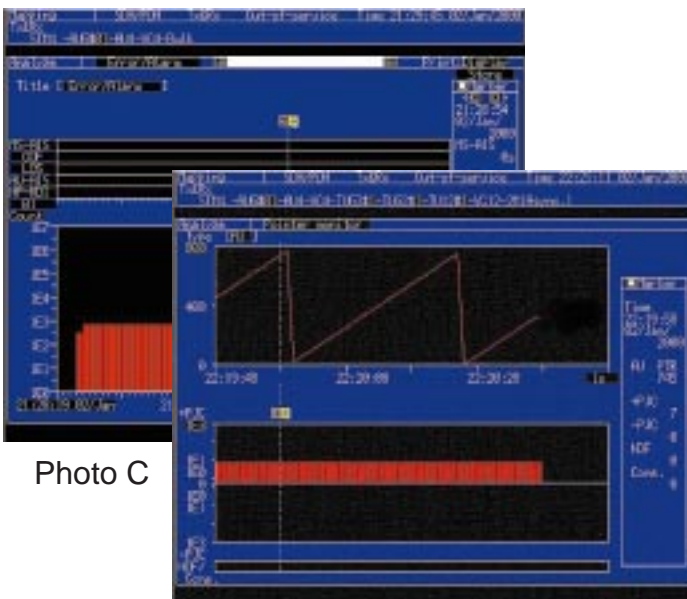

Photo C

## Pointer value monitoring

The MP1570A can display changes of pointer value in a graph. Monitored values are updated in real time.

## MUX/DEMUX function (optional)

The MP1570A allows the user to set frames on or off at every bit rate. If the MUX/DEMUX function is installed, the MP1570A can generate a multiplexing structure including frame alignment signals and perform multiplexer/demultiplexer measurement.

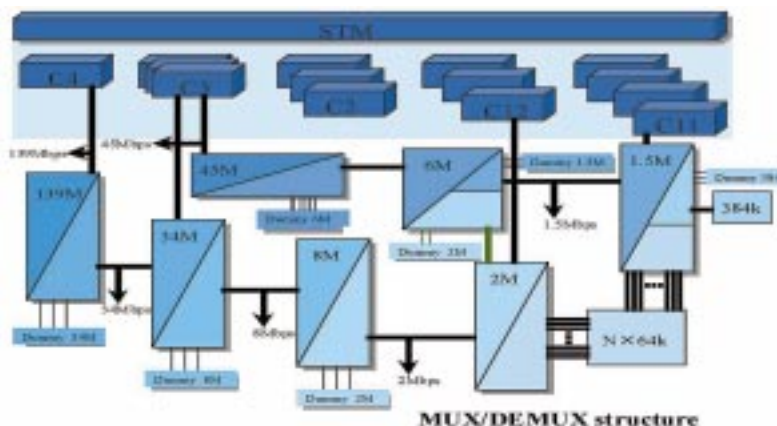

## Through-mode

The user can select one of four through-modes: transparent, overhead/over-write, payload/over-write, and add/drop.

### Transparent :

For in-service monitoring.

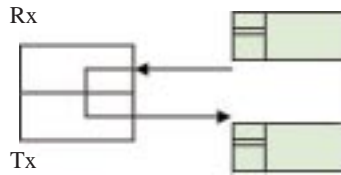

### Add/Drop :

Add/Drop of external DS1/DS3/PDH signals.

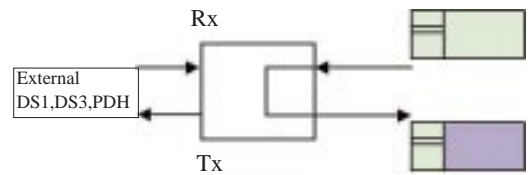

### Overhead/over-write :

Insertion of internal STS-3SPE/VC4, VT6/TU2, VT2/TU12, and VT1.5/TU11 signals.

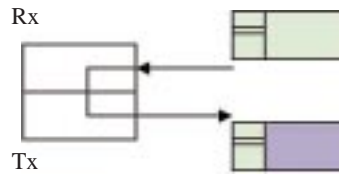

### Overhead/over-write :

Modification of SOH/POH byte. Addition of various errors/alarms.

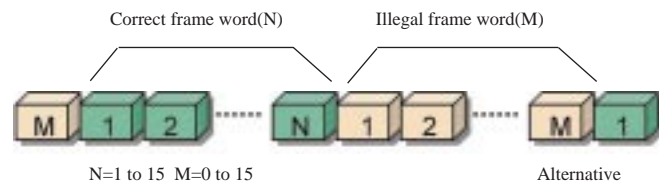
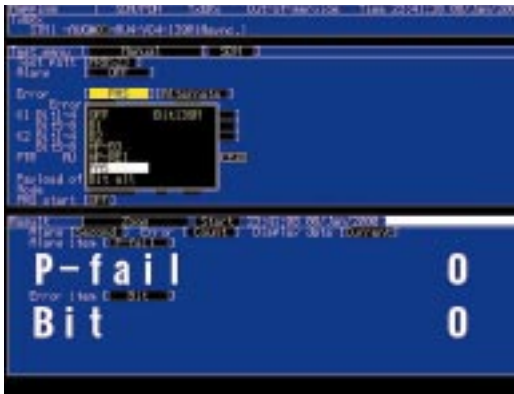
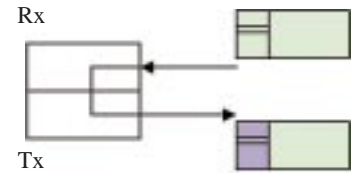

Frame alignment error simulation

## Enhanced error/alarm simulation

The MP1570A can generate normal and abnormal frames alternately to test the frame synchronization function of terminal equipment. (This function is an SDH FAS error addition function.)

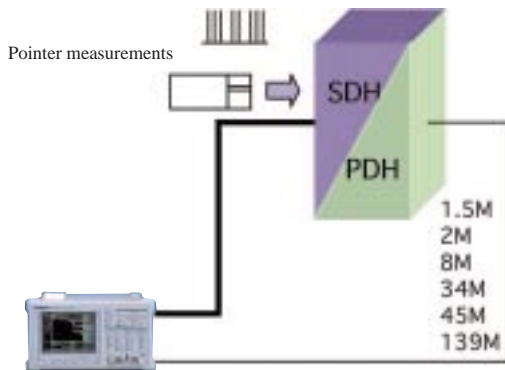

## Pointer sequence test by simple operation

The user can select one of four through-modes: transparent, overhead/over-write, payload/over-write, and add/drop.

# Specifications

## • MP0121A 2/8/34/139/156M\*<sup>1</sup> Unit

Bit rate	2.048, 8.448, 34.368, 139.264 Mb/s
Level/waveform	Conforms to ITU-T G.703 (with 20 dB monitoring point)
Connectors	BNC (75 Ω, unbalanced), 3-pin Siemens (120 Ω, balanced) 2.048 Mb/s: HDB3 (balanced/unbalanced) 8.448, 34.368 Mb/s: HDB3 (unbalanced) 139.264 Mb/s: CMI (unbalanced)
Clock	Internal (accuracy: ±7 ppm, jitter unit not installed), external (ECL [AC] 50 Ω), received signal
Frame format	Unframed: 2, 8, 34, 139 Mb/s Framed: 2 Mb/s (with/without CRC-4 at channels 30/31, G.704), 8 Mb/s (G.742), 34 Mb/s (G.751), 139 Mb/s (G.751), MUX/DEMUX (Option 06)
Test patterns	PRBS: 2 <sup>11</sup> - 1, 2 <sup>15</sup> - 1, 2 <sup>20</sup> - 1, 2 <sup>23</sup> - 1 (O.151) Word: 16-bit programmable, all 0, all 1
Error addition	Bit (all, test pattern), code, E-bit Timing: Single, rate (1E-3, 1E-4, 1E-5, 1E-6, 1E-7) FAS: n in 16 (n: 1 to 4), all
Alarm addition	LOS, LOF, AIS, RDI, RDI (MF) Timing: All
Measurements	Mode: Single, repeat, manual In-service Errors: Frame, code, CRC-4, E-bit Alarms: Power-fail, LOS, AIS, LOF, MF loss, RDI, RDI (MF) Error performance: G.821 (inc. Annex D), M.2100, G.826 Out-of-service Errors: Frame, code, CRC-4, E-bit, bit Alarms: Power-fail, LOS, AIS, LOF, MF loss, RDI, RDI (MF), sync loss Error performance: G.821 (inc. Annex D), M.2100, G.826
LEDs	LOS, AIS, LOF, MF loss, RDI, RDI (MF), sync loss, errors
Monitor	Frame word
Trouble search	Auto search for errors/alarms in all measured channels
Delay measurement	0 to 1 s
Auxiliary interface	Clock sync output, frame sync output, error output

\*1: Built-in 156M CMI (electrical) interface

## • MP0122A 1.5/45/52M\*<sup>1</sup> Unit, MP0122B 1.5/45/52/52M\*<sup>2</sup> (1.31)Unit

Bit rate	1.544, 44.736 Mb/s
Level/waveform	1.544 Mb/s: ANSI T1.102 (with 20 dB monitoring point), 0/655 ft 44.736 Mb/s: ANSI T1.102 (with 20 dB monitoring point), 0/450/900 ft
Connectors	BNC (75 Ω, unbalanced), Bantam (100 Ω, balanced) 1.544 Mb/s: AMI/B8ZS (balanced), 44.736 Mb/s: B3ZS (unbalanced)
Clock	Internal (accuracy: ±7 ppm, jitter unit not installed), external (ECL [AC] 50 Ω) received signal
Frame format	Unframed: 1.5, 45 Mb/s Framed: 1.5 Mb/s (D4, ESF, Japan ESF* <sup>3</sup> ), 45 Mb/s (M13, C-bit), MUX/DEMUX (Option 07)
Test patterns	PRBS: 2 <sup>11</sup> - 1, 2 <sup>15</sup> - 1, 2 <sup>20</sup> - 1 (zero suppress), 2 <sup>20</sup> - 1, 2 <sup>23</sup> - 1 (O.151) Word: 16-bit program, all 0, all 1, 3 in 24 (1.5 Mb/s)
Error addition	Bit (all, test pattern), code, parity, CRC-6, C-bit, REI Timing: Single, rate (1E-3, 1E-4, 1E-5, 1E-6, 1E-7) FAS (45 Mb/s): n in 16 (n: 1 to 4), all
X-bit setting	00, 01, 10, 11
Alarm addition	LOS, LOF, AIS, RDI Timing: All
Measurements	Mode: Single, repeat, manual In-service Errors: FAS, code, parity, CRC-6, C-bit, REI Alarms: Power-fail, LOS, AIS, LOF, RDI Error performance: G.821 (inc. Annex D), M.2100, G.826 Out-of-service Errors: FAS, code, parity, CRC-6, C-bit, REI, bit Alarms: Power-fail, LOS, AIS, LOF, RDI, sync loss Error performance: G.821 (inc. Annex D), M.2100, G.826
LEDs	LOS, LOF, AIS, RDI, sync loss, errors
Trouble search	Auto search for errors/alarms in all measured channels
Delay measurement	0 to 1 s
Auxiliary interface	Clock sync output, frame sync output, error output

\*1: Built-in 52M B3ZS (electrical) interface

\*2: Built-in 52M B3ZS (electrical) and optical interfaces

\*3: Mounted Option 09 (Japan Mapping)



● 52/156/622/2488/9953M

Bit rate	51.840, 155.520, 622.080, 2488.320, 9953.28 Mb/s
Level/waveform	52M (electrical: B3ZS)*1: ANSI T1.102, 0/450 ft 52M (optical): As per MP0122B unit optical interface specifications 156M (electrical: CMI)*2: ITU-T G.703 156M (optical): As per optical 156M/622M unit specifications 622M (electrical/optical): As per optical 156M/622M unit and NRZ unit specifications 2488M (electrical/optical): As per 2.5G unit and 2.5G/10G unit specifications 9953M (electrical/optical): As per 2.5G/10G unit specifications
Clock	Internal (accuracy: $\pm 3.5$ ppm, jitter unit not installed), Lock (2 MHz, 1.5 MHz, 64 kHz + 8 kHz, 2 Mb/s, 1.5 Mb/s), external (ECL [AC] 50 $\Omega$ , 9953M: 1.02 to 0.58 Vp-p, 50 $\Omega$ ), received signal
Frame	SDH/SONET, CID pattern, non-frame
Mapping	See Fig. 1
Through	Trance parent, over head overwrite, payload overwrite, Add/Drop
Test patterns	PRBS: $2^{11}-1$ , $2^{15}-1$ , $2^{20}-1$ (zero suppress, MP0122A/B installed), $2^{20}-1$ , $2^{23}-1$ , $2^{31}-1$ (only concatenation mapping 16C/64C) (conform to O.151) Word: 16-bit programmable, all 0, all 1
Error addition	Bit all (all, test pattern), FAS, B1, B2, B3, BIP-2, MS-REI, HP-REI, LP-REI Timing: Single, single (burst) bit (1 to 64000), rate (1E-3, 1E-4, 1E-5, 1E-6, 1E-7, 1E-8, 1E-9) User program AE-B (A: 1.0 to 9.9 step 0.1, B: 2 to 10) Alternative: alarm frame (0 to 8000), normal frame (1 to 8000)
Alarm addition	LOS, LOF, MS-AIS, MS-RDI, AU-AIS, AU-LOP, HP-SLM, HP-TIM, HP-RDI, HP-UNEQ, TU-AIS, TU-LOP, TU-LOM, LP-SLM, LP-TIM, LP-RDI, LP-UNEQ, LP-RFI Timing: Single, single (burst) frame Alternative: alarm frame (0 to 8000), normal frame (1 to 8000), all
Measurements	Mode: Single, repeat, manual In-service/Out-of-service Errors: B1, B2, B3, BIP-2, MS-REI, HP-REI, LP-REI Alarms: Powerfail, LOS, LOF, OOF, MS-AIS, MS-RDI, AU-AIS, AU-LOP, HP-SLM, HP-TIM, HP-RDI, HP-UNEQ, TU-AIS, TU-LOP, TU-LOM, LP-SLM, LP-TIM, LP-RDI, LP-UNEQ, LP-RFI Error performance: G.826, M2101, M2110, M2120 Preset: Alarm measurement condition
LEDs	LOS, LOF, OOF, MS-AIS, MS-RDI, AU-AIS, AU-LOP, HP-RDI, HP-SLM, TU-AIS, TU-LOM, TU-LOP, LP-RDI, LP-RFI, LP-SLM, Tandem, sync. loss, error
Tandem connection	N1 byte (Type 1, Type 2), N2 byte Errors: N2 BIP-2, TC-REI, OEI, IEC Alarms: VC-AIS, ISF, FAS, HP-Incoming-AIS, HP-TC-RDI, HP-ODI, LP-Incoming-AIS, LP-TC-RDI, LP-ODI
Justification	AU pointer, TU pointer, C, C1/C2 Measurement: NDF, +PJC, -PJC, Cons. C, C1/C2
Monitor	SOH, POH, K1/K2, pointer, path trace (TIM alarms detectable), Tandem, payload
Pointer sequence	Signal of opposites polarity, regular with double, regular with missing, double of opposites polarity, 87-3/26-1 (normal, add, cancel), continuous pattern (normal, add, cancel), single pointer adjustment, maximum rate pointer burst, phase transient pointer burst, initialize period polarity, cooldown period
Over head capture	SOH/POH (any 1 byte), H1/H2, K1/K2
Dummy channel setting	Payload: Dummy, copy, mixed payload Setting: POH, pathtrace, SS bit, Tandem
Simultaneous measurement	VC2, VC12, VC11
Trouble search	Auto search for errors/alarms in all measured channels
Delay	Measurement period: 0.5, 1, 2, 5, 10 s Measurement range: 0 to 999 $\mu$ s, 1.0 to 999.9 ms, 1.0 to 10.0 s, Time out Display accuracy: $\pm 5$ $\mu$ s (0.5, 1 s), $\pm 50$ $\mu$ s (2, 5, 10 s)
APS (K1/K2)	Switch time measurement Trigger Internal: B1, B2, B3, BIP-2, MS-REI, HP-REI, LP-REI, MS-AIS, AU-AIS, AU-LOP, HP-RDI, TU-AIS, TU-LOM, TU-LOP, LP-RDI, LP-RFI, Bit External: Measures trigger input signal (active high) Threshold: Specify non-error alarm between 1 ms, 10 ms, 100 ms Sequence generation: 2 to 64 word, repeat (8000 frame) Sequence capture: 2 to 64 word, repeat(8000 frame)
Frequency measurement	Range: $\pm 100$ ppm, Accuracy: $\pm 3.5$ ppm (jitter unit not installed)
Over head test	OH change: SOH/POH 1 byte, K1/K2, RSOH, MSOH, SOH, POH (except B1, B2, B3, BIP-2) PTR 64 frame: AU pointer, TU pointer Timing: Single, Repeat (2 to 64) Setting: PTR, NDF, +PJC, -PJC OH BERT: SOH/POH 1 byte (exclude B1, B2, B3, BIP-2), D1-D3, D4-D12 Test pattern: $2^{11}-1$ , $2^{15}-1$ OH add/drop: SOH/POH 1 byte, D1-D3, D4-D12 (exclude B1, B2, B3, BIP-2 additional type)
Japan mapping (option 09)	VC11 Signaling (8-multiframe, 64-multiframe setting)

Frame memory/capture (option 13)	Memory size: 64 frame (156M, 622M, 2.5G), 26 frame (10G)
Insert/extract	Bit rate: 10G (52M, 156M), 2.5G (52M, 156M)
Payload offset	±100 ppm/0.1 ppm step
Auxiliary	Clock sync output, trigger input, trigger output, DCC interface (V.11), order wire, receive clock output

\*1: Mounted MP0122A/B

\*2: Mounted MP0121A

MP0127A/0128A/0129A are usable (for specifications, refer to the MP1552B data sheet).

• General

Printer	Internal, external
Internal memory	Measurement settings memory: 10, graphics memory: 15
Others	FDD, RS-232C (Option 01)*1, GPIB (Option 02)*1, Ethernet (Option 03)*1, video output (Option 04)*1, buzzer, clock, help, screen copy
EMC	EN55011: 1991, Group 1, Class A EN50082-1: 1992 Harmonic current emissions: EN61000-3-2 (1995)
Safety	EN61010-1: 1993 (Installation Category II, Pollution Degree II)
Dimensions and mass	320 (W) x 177 (H) x 350 (D) mm, 10 kg approx. (excluding plug-in units and options)
Power	100 to 240 Vac, 47.5 to 63 Hz, ≤500 VA
Temperature	0° to +40°C

\*1: The video output, RS-232C, GPIB and Ethernet options cannot all be used simultaneously.

Only the video output + RS-232C, or video output + GPIB, or RS-232C + GPIB board, or Ethernet board combinations support simultaneous use, so change the board combinations according to the purpose.

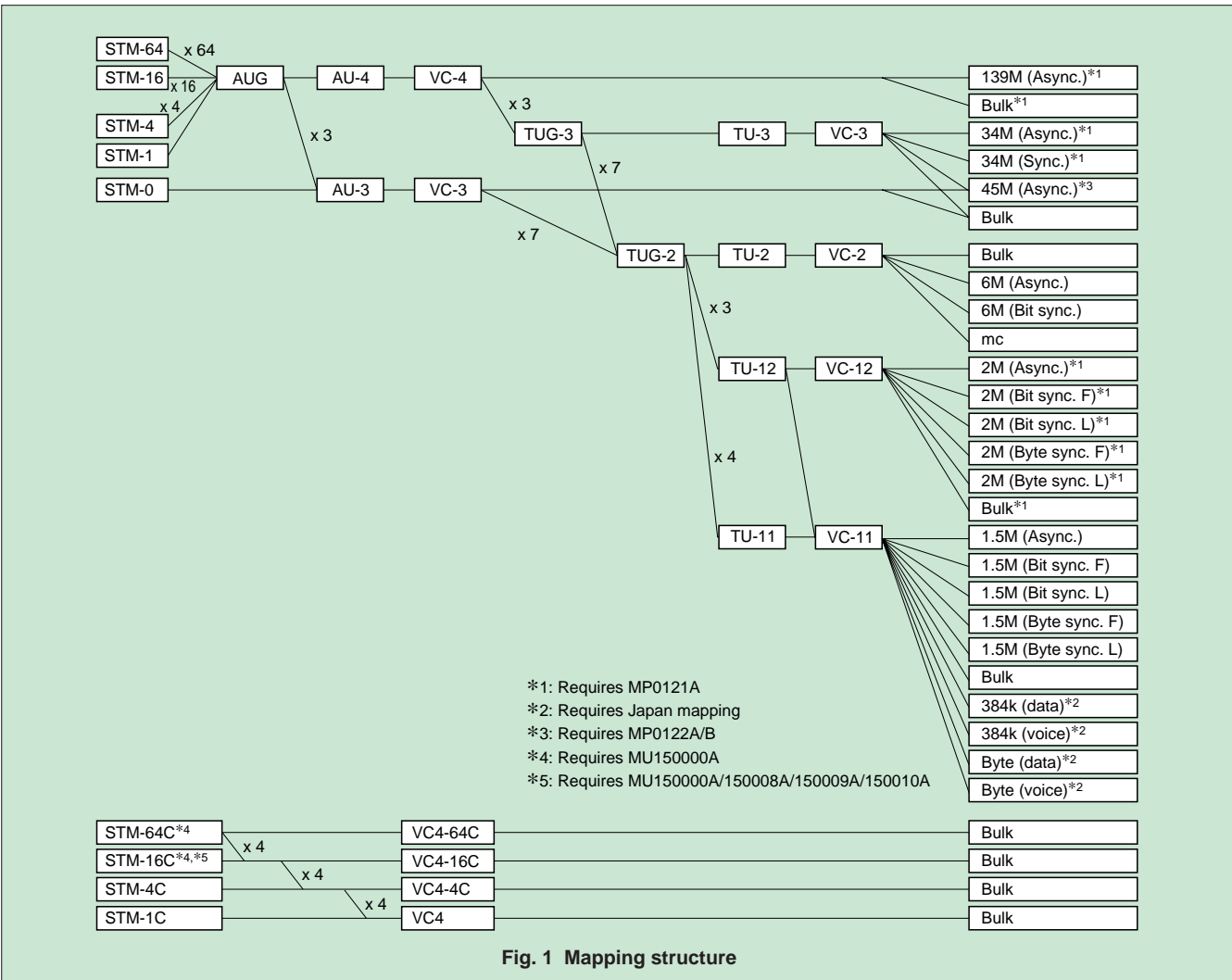
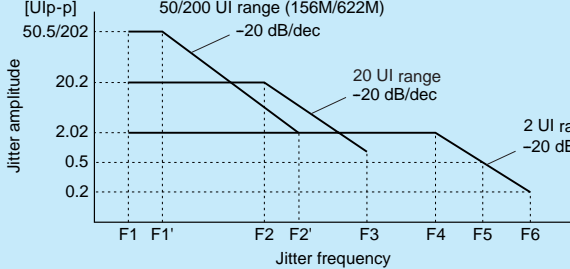
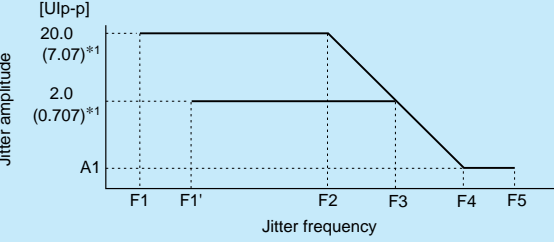

Fig. 1 Mapping structure

• MP0124A/0125A/0126A Jitter Unit

Bit rate	MP0124A: 2.048, 8.448, 34.368, 139.264, 155.520, 622.080 Mb/s MP0125A: 1.544, 44.736, 51.840, 155.520, 622.080 Mb/s MP0126A: 1.544, 2.048, 8.448, 34.368, 44.736, 139.264, 51.840, 155.520, 622.080 Mb/s																																																																																										
Jitter generation	Modulation frequency: 0.1 Hz to 6 MHz Amplitude: 0 to 202.0 Ulp-p Resolution: 0.001 Ulp-p (2 UI range), 0.01 Ulp-p (20 UI range), 0.1 Ulp-p (50/200 UI range)  <table border="1" data-bbox="391 691 1120 995"> <thead> <tr> <th>Bit rate (Mb/s)</th> <th>F1 (Hz)</th> <th>F1' (Hz)</th> <th>F2* (kHz)</th> <th>F2'* (kHz)</th> <th>F3* (kHz)</th> <th>F4* (kHz)</th> <th>F5* (kHz)</th> <th>F6* (kHz)</th> </tr> </thead> <tbody> <tr><td>1.544</td><td>0.1</td><td>—</td><td>0.5</td><td>—</td><td>10</td><td>12.5</td><td>50</td><td>—</td></tr> <tr><td>2.048</td><td>0.1</td><td>—</td><td>1</td><td>—</td><td>20</td><td>27.5</td><td>110</td><td>—</td></tr> <tr><td>8.448</td><td>0.1</td><td>—</td><td>2</td><td>—</td><td>20</td><td>105</td><td>420</td><td>—</td></tr> <tr><td>34.368</td><td>0.1</td><td>—</td><td>5</td><td>—</td><td>100</td><td>250</td><td>1000</td><td>—</td></tr> <tr><td>44.736</td><td>0.1</td><td>—</td><td>5</td><td>—</td><td>100</td><td>250</td><td>1000</td><td>—</td></tr> <tr><td>139.264</td><td>0.1</td><td>—</td><td>5</td><td>—</td><td>100</td><td>1000</td><td>4000</td><td>—</td></tr> <tr><td>51.840</td><td>0.1</td><td>—</td><td>2</td><td>—</td><td>80</td><td>50</td><td>—</td><td>500</td></tr> <tr><td>155.520</td><td>0.1</td><td>1000</td><td>6.5</td><td>25</td><td>500</td><td>150</td><td>—</td><td>1500</td></tr> <tr><td>622.080</td><td>0.1</td><td>500</td><td>25</td><td>50</td><td>500</td><td>600</td><td>—</td><td>6000</td></tr> </tbody> </table> <p>*: typical value                  Accuracy (at Fr): <math>\pm 5\% \pm 0.05</math> Ulp-p (2 UI range), <math>\pm 5\% \pm 0.3</math> Ulp-p (20 UI range), <math>\pm 5\% \pm 0.8</math> Ulp-p (50 UI range), <math>\pm 5\% \pm 3.2</math> Ulp-p (200 UI range) *Fr: 100 kHz (156M/622M, 2UI range), 500 Hz (1.5M, 20UI range), 1 kHz (others)</p>	Bit rate (Mb/s)	F1 (Hz)	F1' (Hz)	F2* (kHz)	F2'* (kHz)	F3* (kHz)	F4* (kHz)	F5* (kHz)	F6* (kHz)	1.544	0.1	—	0.5	—	10	12.5	50	—	2.048	0.1	—	1	—	20	27.5	110	—	8.448	0.1	—	2	—	20	105	420	—	34.368	0.1	—	5	—	100	250	1000	—	44.736	0.1	—	5	—	100	250	1000	—	139.264	0.1	—	5	—	100	1000	4000	—	51.840	0.1	—	2	—	80	50	—	500	155.520	0.1	1000	6.5	25	500	150	—	1500	622.080	0.1	500	25	50	500	600	—	6000
Bit rate (Mb/s)	F1 (Hz)	F1' (Hz)	F2* (kHz)	F2'* (kHz)	F3* (kHz)	F4* (kHz)	F5* (kHz)	F6* (kHz)																																																																																			
1.544	0.1	—	0.5	—	10	12.5	50	—																																																																																			
2.048	0.1	—	1	—	20	27.5	110	—																																																																																			
8.448	0.1	—	2	—	20	105	420	—																																																																																			
34.368	0.1	—	5	—	100	250	1000	—																																																																																			
44.736	0.1	—	5	—	100	250	1000	—																																																																																			
139.264	0.1	—	5	—	100	1000	4000	—																																																																																			
51.840	0.1	—	2	—	80	50	—	500																																																																																			
155.520	0.1	1000	6.5	25	500	150	—	1500																																																																																			
622.080	0.1	500	25	50	500	600	—	6000																																																																																			
Jitter tolerance measurement	Conforms to ITU-T G.823/G.824/G.825/G.958 Display: Numeric, graphic																																																																																										
Frequency offset	Range: $\pm 999.9$ ppm/step (0.1 ppm, Jitter: off), $\pm 70$ ppm/step (0.1 ppm, Jitter: on/off) Accuracy: $\pm 0.1$ ppm (after power-on, calibrates after 60 min. warm-up, 23° $\pm 5^\circ$ C)																																																																																										
Auxiliary interface	External modulation input, external 10 MHz reference input, reference clock output																																																																																										
Jitter measurement	Conforms to ITU-T O.172 [TABLE 8 ( $f_1$ - $f_2$ ), TABLE 9, pseudo-random signal ( $f_1$ - $f_2$ ) only] Modulation frequency: 2 Hz to 5 MHz Amplitude: 0 to 20.00 Ulp-p, 0 to 7.07 Ulrms (Option 01) Resolution: 0.001 Ulp-p/0.001 Ulrms (2 UI range), 0.01 Ulp-p/0.01 Ulrms (20 UI range)  <table border="1" data-bbox="391 1570 1120 1868"> <thead> <tr> <th>Bit rate (Mb/s)</th> <th>A1 (Ulp-p)</th> <th>F1 (Hz)</th> <th>F1' (Hz)</th> <th>F2 (kHz)</th> <th>F3 (kHz)</th> <th>F4 (kHz)</th> <th>F5 (kHz)</th> </tr> </thead> <tbody> <tr><td>1.544</td><td>0.5</td><td>2</td><td>20</td><td>0.2</td><td>2.5</td><td>10</td><td>40/(15)<sup>*2</sup></td></tr> <tr><td>2.048</td><td>0.5</td><td>2</td><td>20</td><td>0.45</td><td>6</td><td>25</td><td>100/(18)<sup>*2</sup></td></tr> <tr><td>8.448</td><td>0.5</td><td>2</td><td>20</td><td>0.2</td><td>10</td><td>100</td><td>400/(70)<sup>*2</sup></td></tr> <tr><td>34.368</td><td>0.5</td><td>2</td><td>20</td><td>0.5</td><td>40</td><td>500</td><td>800/(300)<sup>*2</sup></td></tr> <tr><td>44.736</td><td>0.5</td><td>2</td><td>20</td><td>3</td><td>40</td><td>200</td><td>400</td></tr> <tr><td>139.264</td><td>0.5</td><td>2</td><td>20</td><td>0.25</td><td>50</td><td>1000</td><td>3500/(1200)<sup>*2</sup></td></tr> <tr><td>51.840</td><td>0.2</td><td>2</td><td>20</td><td>0.2</td><td>5</td><td>100</td><td>400</td></tr> <tr><td>155.520</td><td>0.2</td><td>2</td><td>20</td><td>0.7</td><td>20</td><td>500</td><td>1300</td></tr> <tr><td>622.080</td><td>0.2</td><td>2</td><td>20</td><td>20</td><td>200</td><td>2000</td><td>5000</td></tr> </tbody> </table> <p>*1: rms; F1, F1' = 100 Hz *2: 20 UI range in parentheses</p>	Bit rate (Mb/s)	A1 (Ulp-p)	F1 (Hz)	F1' (Hz)	F2 (kHz)	F3 (kHz)	F4 (kHz)	F5 (kHz)	1.544	0.5	2	20	0.2	2.5	10	40/(15) <sup>*2</sup>	2.048	0.5	2	20	0.45	6	25	100/(18) <sup>*2</sup>	8.448	0.5	2	20	0.2	10	100	400/(70) <sup>*2</sup>	34.368	0.5	2	20	0.5	40	500	800/(300) <sup>*2</sup>	44.736	0.5	2	20	3	40	200	400	139.264	0.5	2	20	0.25	50	1000	3500/(1200) <sup>*2</sup>	51.840	0.2	2	20	0.2	5	100	400	155.520	0.2	2	20	0.7	20	500	1300	622.080	0.2	2	20	20	200	2000	5000										
Bit rate (Mb/s)	A1 (Ulp-p)	F1 (Hz)	F1' (Hz)	F2 (kHz)	F3 (kHz)	F4 (kHz)	F5 (kHz)																																																																																				
1.544	0.5	2	20	0.2	2.5	10	40/(15) <sup>*2</sup>																																																																																				
2.048	0.5	2	20	0.45	6	25	100/(18) <sup>*2</sup>																																																																																				
8.448	0.5	2	20	0.2	10	100	400/(70) <sup>*2</sup>																																																																																				
34.368	0.5	2	20	0.5	40	500	800/(300) <sup>*2</sup>																																																																																				
44.736	0.5	2	20	3	40	200	400																																																																																				
139.264	0.5	2	20	0.25	50	1000	3500/(1200) <sup>*2</sup>																																																																																				
51.840	0.2	2	20	0.2	5	100	400																																																																																				
155.520	0.2	2	20	0.7	20	500	1300																																																																																				
622.080	0.2	2	20	20	200	2000	5000																																																																																				

Jitter measurement	Accuracy [Ulp-p]: $\pm 5\%$ $\pm W$ Ulp-p (Fr Hz) 156 Mb/s (optical): When input level $-25$ dBm max. add 0.01 Ulp-p/dB to above specifications. 622 Mb/s (optical): When input level $-20$ dBm max. add 0.01 Ulp-p/dB to above specifications. [Ulrms]: $\pm 5\%$ $\pm Y$ Ulp-p (Fr Hz) 156 Mb/s (optical): When input level $-25$ dBm max. add 0.002 Ulrms/dB to above specifications. 622 Mb/s (optical): When input level $-20$ dBm max. add 0.002 Ulrms/dB to above specifications. Frequency response (Fr Hz): $\pm 5\%$ (2 to 20 Hz), $\pm 2\%$ (20 Hz to 300 kHz), $\pm 3\%$ (300 kHz to 1 MHz), $\pm 5\%$ (1 to 3 MHz), $\pm 10\%$ (3 to 5 MHz) *fr: 100 kHz (156M/622M, 2 UI range), 1 kHz (others)																																																																																																												
	<table border="1"> <thead> <tr> <th rowspan="2">Bit rate (Mb/s)</th> <th colspan="2">W (Ulp-p)*<sup>1</sup></th> <th colspan="2">Y (Ulrms)*<sup>2</sup></th> </tr> <tr> <th>2 UI</th> <th>20 UI</th> <th>2 UI</th> <th>20 UI</th> </tr> </thead> <tbody> <tr><td>1.544 (CLK)</td><td>0.015</td><td>0.20</td><td>0.005</td><td>0.03</td></tr> <tr><td>1.544 (AMI/B8ZS)</td><td>0.040</td><td>0.22</td><td>0.006</td><td>0.04</td></tr> <tr><td>2.048 (CLK)</td><td>0.015</td><td>0.20</td><td>0.005</td><td>0.03</td></tr> <tr><td>2.048 (HDB3)</td><td>0.040</td><td>0.22</td><td>0.006</td><td>0.04</td></tr> <tr><td>8.448 (CLK)</td><td>0.015</td><td>0.20</td><td>0.005</td><td>0.03</td></tr> <tr><td>8.448 (HDB3)</td><td>0.040</td><td>0.22</td><td>0.006</td><td>0.04</td></tr> <tr><td>34.368 (CLK)</td><td>0.015</td><td>0.20</td><td>0.005</td><td>0.03</td></tr> <tr><td>34.368 (HDB3)</td><td>0.040</td><td>0.22</td><td>0.017</td><td>0.04</td></tr> <tr><td>44.736 (CLK)</td><td>0.015</td><td>0.20</td><td>0.005</td><td>0.03</td></tr> <tr><td>44.736 (B3ZS)</td><td>0.040</td><td>0.22</td><td>0.006</td><td>0.04</td></tr> </tbody> </table>	Bit rate (Mb/s)	W (Ulp-p)* <sup>1</sup>		Y (Ulrms)* <sup>2</sup>		2 UI	20 UI	2 UI	20 UI	1.544 (CLK)	0.015	0.20	0.005	0.03	1.544 (AMI/B8ZS)	0.040	0.22	0.006	0.04	2.048 (CLK)	0.015	0.20	0.005	0.03	2.048 (HDB3)	0.040	0.22	0.006	0.04	8.448 (CLK)	0.015	0.20	0.005	0.03	8.448 (HDB3)	0.040	0.22	0.006	0.04	34.368 (CLK)	0.015	0.20	0.005	0.03	34.368 (HDB3)	0.040	0.22	0.017	0.04	44.736 (CLK)	0.015	0.20	0.005	0.03	44.736 (B3ZS)	0.040	0.22	0.006	0.04																																																	
	Bit rate (Mb/s)		W (Ulp-p)* <sup>1</sup>		Y (Ulrms)* <sup>2</sup>																																																																																																								
		2 UI	20 UI	2 UI	20 UI																																																																																																								
	1.544 (CLK)	0.015	0.20	0.005	0.03																																																																																																								
	1.544 (AMI/B8ZS)	0.040	0.22	0.006	0.04																																																																																																								
	2.048 (CLK)	0.015	0.20	0.005	0.03																																																																																																								
	2.048 (HDB3)	0.040	0.22	0.006	0.04																																																																																																								
	8.448 (CLK)	0.015	0.20	0.005	0.03																																																																																																								
	8.448 (HDB3)	0.040	0.22	0.006	0.04																																																																																																								
34.368 (CLK)	0.015	0.20	0.005	0.03																																																																																																									
34.368 (HDB3)	0.040	0.22	0.017	0.04																																																																																																									
44.736 (CLK)	0.015	0.20	0.005	0.03																																																																																																									
44.736 (B3ZS)	0.040	0.22	0.006	0.04																																																																																																									
<table border="1"> <thead> <tr> <th rowspan="2">Bit rate (Mb/s)</th> <th colspan="2">W (Ulp-p)*<sup>1</sup></th> <th colspan="2">Y (Ulrms)*<sup>2</sup></th> </tr> <tr> <th>2 UI</th> <th>20 UI</th> <th>2 UI</th> <th>20 UI</th> </tr> </thead> <tbody> <tr><td>139.264 (CLK)</td><td>0.030</td><td>0.20</td><td>0.005</td><td>0.03</td></tr> <tr><td>139.264 (CMI)</td><td>0.040</td><td>0.30</td><td>0.022</td><td>0.06</td></tr> <tr><td>51.840 (CLK)</td><td>0.015</td><td>0.20</td><td>0.005</td><td>0.03</td></tr> <tr><td>51.840 (B3ZS)</td><td>0.040</td><td>0.22</td><td>0.017</td><td>0.05</td></tr> <tr><td>51.840 (optical)*<sup>3</sup></td><td>0.070</td><td>0.30</td><td>0.022</td><td>0.06</td></tr> <tr><td>155.52 (CLK)</td><td>0.035</td><td>0.20</td><td>0.017</td><td>0.05</td></tr> <tr><td>155.52 (CMI)</td><td>0.070</td><td>0.30</td><td>0.022</td><td>0.06</td></tr> <tr><td>155.52 (optical)*<sup>3</sup></td><td>0.070</td><td>0.30</td><td>0.022</td><td>0.06</td></tr> <tr><td>622.08 (CLK)</td><td>0.050</td><td>0.20</td><td>0.027</td><td>0.07</td></tr> <tr><td>622.08 (optical)*<sup>3</sup></td><td>0.100</td><td>0.30</td><td>0.032</td><td>0.08</td></tr> </tbody> </table>	Bit rate (Mb/s)	W (Ulp-p)* <sup>1</sup>		Y (Ulrms)* <sup>2</sup>		2 UI	20 UI	2 UI	20 UI	139.264 (CLK)	0.030	0.20	0.005	0.03	139.264 (CMI)	0.040	0.30	0.022	0.06	51.840 (CLK)	0.015	0.20	0.005	0.03	51.840 (B3ZS)	0.040	0.22	0.017	0.05	51.840 (optical)* <sup>3</sup>	0.070	0.30	0.022	0.06	155.52 (CLK)	0.035	0.20	0.017	0.05	155.52 (CMI)	0.070	0.30	0.022	0.06	155.52 (optical)* <sup>3</sup>	0.070	0.30	0.022	0.06	622.08 (CLK)	0.050	0.20	0.027	0.07	622.08 (optical)* <sup>3</sup>	0.100	0.30	0.032	0.08																																																		
Bit rate (Mb/s)		W (Ulp-p)* <sup>1</sup>		Y (Ulrms)* <sup>2</sup>																																																																																																									
	2 UI	20 UI	2 UI	20 UI																																																																																																									
139.264 (CLK)	0.030	0.20	0.005	0.03																																																																																																									
139.264 (CMI)	0.040	0.30	0.022	0.06																																																																																																									
51.840 (CLK)	0.015	0.20	0.005	0.03																																																																																																									
51.840 (B3ZS)	0.040	0.22	0.017	0.05																																																																																																									
51.840 (optical)* <sup>3</sup>	0.070	0.30	0.022	0.06																																																																																																									
155.52 (CLK)	0.035	0.20	0.017	0.05																																																																																																									
155.52 (CMI)	0.070	0.30	0.022	0.06																																																																																																									
155.52 (optical)* <sup>3</sup>	0.070	0.30	0.022	0.06																																																																																																									
622.08 (CLK)	0.050	0.20	0.027	0.07																																																																																																									
622.08 (optical)* <sup>3</sup>	0.100	0.30	0.032	0.08																																																																																																									
*1: With HP1 + LP, *2: With HP + LP, *3: $+10^\circ$ to $+40^\circ\text{C}$																																																																																																													
Filter																																																																																																													
<table border="1"> <thead> <tr> <th>Bit rate (Mb/s)</th> <th>HP0 (Hz)</th> <th>HP1 (Hz)</th> <th>HP2 (kHz)</th> <th>HP2' (kHz)</th> <th>HP (kHz)</th> <th>LP (kHz)</th> </tr> </thead> <tbody> <tr><td>1.544</td><td>10</td><td>10</td><td>8</td><td>–</td><td>12</td><td>40</td></tr> <tr><td>2.048</td><td>10</td><td>20</td><td>18</td><td>0.7</td><td>12</td><td>100</td></tr> <tr><td>8.448</td><td>10</td><td>20</td><td>3</td><td>80</td><td>12</td><td>400</td></tr> <tr><td>34.368</td><td>10</td><td>100</td><td>10</td><td>–</td><td>12</td><td>800</td></tr> <tr><td>44.736</td><td>10</td><td>10</td><td>30</td><td>–</td><td>12</td><td>400</td></tr> <tr><td>139.264</td><td>10</td><td>200</td><td>10</td><td>–</td><td>12</td><td>3500</td></tr> <tr><td>51.840</td><td>10</td><td>100</td><td>20</td><td>–</td><td>12</td><td>400</td></tr> <tr><td>155.520</td><td>10</td><td>500</td><td>65</td><td>–</td><td>12</td><td>1300</td></tr> <tr><td>622.080</td><td>10</td><td>1000</td><td>250</td><td>–</td><td>12</td><td>5000</td></tr> </tbody> </table>	Bit rate (Mb/s)	HP0 (Hz)	HP1 (Hz)	HP2 (kHz)	HP2' (kHz)	HP (kHz)	LP (kHz)	1.544	10	10	8	–	12	40	2.048	10	20	18	0.7	12	100	8.448	10	20	3	80	12	400	34.368	10	100	10	–	12	800	44.736	10	10	30	–	12	400	139.264	10	200	10	–	12	3500	51.840	10	100	20	–	12	400	155.520	10	500	65	–	12	1300	622.080	10	1000	250	–	12	5000																																							
Bit rate (Mb/s)	HP0 (Hz)	HP1 (Hz)	HP2 (kHz)	HP2' (kHz)	HP (kHz)	LP (kHz)																																																																																																							
1.544	10	10	8	–	12	40																																																																																																							
2.048	10	20	18	0.7	12	100																																																																																																							
8.448	10	20	3	80	12	400																																																																																																							
34.368	10	100	10	–	12	800																																																																																																							
44.736	10	10	30	–	12	400																																																																																																							
139.264	10	200	10	–	12	3500																																																																																																							
51.840	10	100	20	–	12	400																																																																																																							
155.520	10	500	65	–	12	1300																																																																																																							
622.080	10	1000	250	–	12	5000																																																																																																							
Hit measurement	Count, seconds, % free seconds																																																																																																												
Jitter transfer measurement	Conforms to ITU-T G.823/G.824/G.958 [selective bandwidth: $\leq 10$ Hz (modulation frequency: $\geq 20$ Hz)] Display: Numeric, graphic																																																																																																												
Frequency measurement	Resolution: 0.1 ppm, Display: Hz or ppm (after power-on, calibrates after 60 min. warm-up, $23^\circ \pm 5^\circ\text{C}$ )																																																																																																												
Auxiliary interface	Demodulation output, reference clock input																																																																																																												
Wander generation	Modulation frequency: 10 $\mu\text{Hz}$ to 0.2 Hz (sine wave)																																																																																																												
	<table border="1"> <thead> <tr> <th rowspan="2">Bit rate (Mb/s)</th> <th colspan="3">Amplitude</th> <th colspan="6">Frequency</th> </tr> <tr> <th>A0 (Ulp-p)</th> <th>A1 (Ulp-p)</th> <th>A2 (Ulp-p)</th> <th>f0 (<math>\mu\text{Hz}</math>)</th> <th>f1 (<math>\mu\text{Hz}</math>)</th> <th>f2 (mHz)</th> <th>f3 (mHz)</th> <th>f4 (mHz)</th> <th>f5 (mHz)</th> </tr> </thead> <tbody> <tr><td>1.544</td><td>40</td><td>–</td><td>20</td><td>10</td><td>–</td><td>–</td><td>65</td><td>130</td><td>200</td></tr> <tr><td>2.048</td><td>40</td><td>–</td><td>20</td><td>10</td><td>–</td><td>–</td><td>65</td><td>130</td><td>200</td></tr> <tr><td>8.448</td><td>200</td><td>–</td><td>20</td><td>10</td><td>–</td><td>–</td><td>13</td><td>130</td><td>200</td></tr> <tr><td>34.368</td><td>1000</td><td>113</td><td>20</td><td>10</td><td>180</td><td>1.6</td><td>23</td><td>130</td><td>200</td></tr> <tr><td>44.736</td><td>1200</td><td>135</td><td>20</td><td>10</td><td>180</td><td>1.6</td><td>19</td><td>130</td><td>200</td></tr> <tr><td>139.264</td><td>3000</td><td>338</td><td>50</td><td>10</td><td>180</td><td>1.6</td><td>19</td><td>130</td><td>200</td></tr> <tr><td>51.840</td><td>1200</td><td>135</td><td>20</td><td>10</td><td>180</td><td>1.6</td><td>19</td><td>130</td><td>200</td></tr> <tr><td>155.520</td><td>3600</td><td>406</td><td>50</td><td>10</td><td>180</td><td>1.6</td><td>16</td><td>130</td><td>200</td></tr> <tr><td>622.080</td><td>14400</td><td>1620</td><td>200</td><td>10</td><td>180</td><td>1.6</td><td>16</td><td>130</td><td>200</td></tr> </tbody> </table>	Bit rate (Mb/s)	Amplitude			Frequency						A0 (Ulp-p)	A1 (Ulp-p)	A2 (Ulp-p)	f0 ( $\mu\text{Hz}$ )	f1 ( $\mu\text{Hz}$ )	f2 (mHz)	f3 (mHz)	f4 (mHz)	f5 (mHz)	1.544	40	–	20	10	–	–	65	130	200	2.048	40	–	20	10	–	–	65	130	200	8.448	200	–	20	10	–	–	13	130	200	34.368	1000	113	20	10	180	1.6	23	130	200	44.736	1200	135	20	10	180	1.6	19	130	200	139.264	3000	338	50	10	180	1.6	19	130	200	51.840	1200	135	20	10	180	1.6	19	130	200	155.520	3600	406	50	10	180	1.6	16	130	200	622.080	14400	1620	200	10	180	1.6	16	130
Bit rate (Mb/s)	Amplitude			Frequency																																																																																																									
	A0 (Ulp-p)	A1 (Ulp-p)	A2 (Ulp-p)	f0 ( $\mu\text{Hz}$ )	f1 ( $\mu\text{Hz}$ )	f2 (mHz)	f3 (mHz)	f4 (mHz)	f5 (mHz)																																																																																																				
1.544	40	–	20	10	–	–	65	130	200																																																																																																				
2.048	40	–	20	10	–	–	65	130	200																																																																																																				
8.448	200	–	20	10	–	–	13	130	200																																																																																																				
34.368	1000	113	20	10	180	1.6	23	130	200																																																																																																				
44.736	1200	135	20	10	180	1.6	19	130	200																																																																																																				
139.264	3000	338	50	10	180	1.6	19	130	200																																																																																																				
51.840	1200	135	20	10	180	1.6	19	130	200																																																																																																				
155.520	3600	406	50	10	180	1.6	16	130	200																																																																																																				
622.080	14400	1620	200	10	180	1.6	16	130	200																																																																																																				
Wander measurement (Option 02)	Reference input: 1.544M (AMI/B8ZS, clock), 2.048M (HDB3, clock) Measurement range p-p: 0.0 to 3.2E5 ns, +p/-p: 0.0 to 1.6E5 ns, TIE: $\pm 0.0$ to 1.6E5 ns, MTIE*: 0.0 to 1E6 ns, TDEV*: 0.0 to 1E6 ns *: MTIE, TDEV measurement require external PC and MX150001A Wander (MTIE, TDEV) Application Software Resolution: 0.1 ns Sampling interval: 25 ms Filter: DC to 0.01 Hz, DC to 10 Hz, 0.01 Hz to 10 Hz Display: Numeric, graphic																																																																																																												

• MP0130A 2.5G Jitter Unit

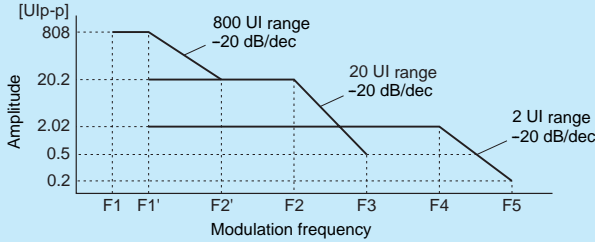
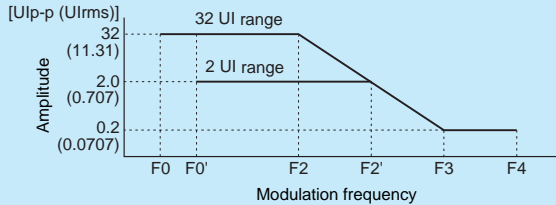
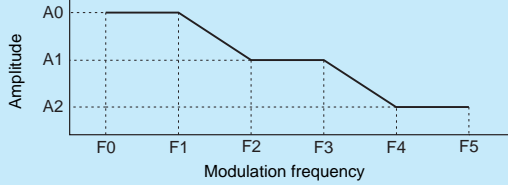
<p>Jitter generation</p>	<p>Frequency: 2488.32 MHz                      Modulation frequency: 0.1 Hz to 20 MHz                      Amplitude: 0 to 808.0 Ulp-p</p>  <table border="1" data-bbox="384 561 1067 638"> <thead> <tr> <th>Bit rate</th> <th>F1 (Hz)</th> <th>F1' (Hz)</th> <th>F2 (Hz)</th> <th>F2' (kHz)</th> <th>F3 (kHz)</th> <th>F4 (kHz)</th> <th>F5 (kHz)</th> </tr> </thead> <tbody> <tr> <td>2488.32 Mb/s</td> <td>0.1</td> <td>15</td> <td>600</td> <td>25</td> <td>500</td> <td>2,000</td> <td>20,000</td> </tr> </tbody> </table>	Bit rate	F1 (Hz)	F1' (Hz)	F2 (Hz)	F2' (kHz)	F3 (kHz)	F4 (kHz)	F5 (kHz)	2488.32 Mb/s	0.1	15	600	25	500	2,000	20,000																							
Bit rate	F1 (Hz)	F1' (Hz)	F2 (Hz)	F2' (kHz)	F3 (kHz)	F4 (kHz)	F5 (kHz)																																	
2488.32 Mb/s	0.1	15	600	25	500	2,000	20,000																																	
<p>Jitter tolerance measurement</p>	<p>Conforms to ITU-T G.825, G.958A, G.958B, user, Bellcore 253</p>																																							
<p>Frequency offset</p>	<p>±70 ppm/step (0.1 ppm, jitter: on/off)</p>																																							
<p>Auxiliary interface</p>	<p>External clock input, reference clock output</p>																																							
<p>Jitter measurement</p>	<p>Frequency: 2488.32 MHz ±50 ppm, conforms to ITU-T O.172 [TABLE 8 (f<sub>1</sub>-f<sub>2</sub>) only]</p>  <table border="1" data-bbox="389 1012 1075 1119"> <thead> <tr> <th>Bit rate</th> <th>F0 (Hz)</th> <th>F0' (Hz)</th> <th>F2 (kHz)</th> <th>F2' (kHz)</th> <th>F3 (kHz)</th> <th>F4 (Hz)</th> </tr> </thead> <tbody> <tr> <td rowspan="2">2488.32 Mb/s</td> <td>2 UI</td> <td>—</td> <td>100</td> <td>—</td> <td>100</td> <td>20,000</td> </tr> <tr> <td>32 UI</td> <td>10</td> <td>—</td> <td>6.25</td> <td>—</td> <td>20,000</td> </tr> </tbody> </table> <p>Accuracy (Mounted MU150008A, MU150009A, MU150001A)                      [Ulp-p]: ±5% ±W Ulp-p (Fr Hz)                      2488 Mb/s (optical): When input level -12 to -10 dBm max. add 0.01 Ulp-p/dB to above specifications.                      [Ulrms]: ±5% ±Y Ulp-p (Fr Hz)                      2488 Mb/s (optical): When input level -12 to -10 dBm max. add 0.002 Ulrms/dB to above specifications.</p> <table border="1" data-bbox="389 1242 884 1349"> <thead> <tr> <th rowspan="2">Bit rate (Mb/s)</th> <th colspan="2">W (Ulp-p)<sup>*1</sup></th> <th colspan="2">Y (Ulrms)<sup>*2</sup></th> </tr> <tr> <th>2 UI</th> <th>20 UI</th> <th>2 UI</th> <th>20 UI</th> </tr> </thead> <tbody> <tr> <td>2488 (CLK)</td> <td>0.030</td> <td>0.60</td> <td>0.007</td> <td>0.35</td> </tr> <tr> <td>2488 (optical)</td> <td>0.100</td> <td>2.20</td> <td>0.027</td> <td>0.55</td> </tr> </tbody> </table>	Bit rate	F0 (Hz)	F0' (Hz)	F2 (kHz)	F2' (kHz)	F3 (kHz)	F4 (Hz)	2488.32 Mb/s	2 UI	—	100	—	100	20,000	32 UI	10	—	6.25	—	20,000	Bit rate (Mb/s)	W (Ulp-p) <sup>*1</sup>		Y (Ulrms) <sup>*2</sup>		2 UI	20 UI	2 UI	20 UI	2488 (CLK)	0.030	0.60	0.007	0.35	2488 (optical)	0.100	2.20	0.027	0.55
Bit rate	F0 (Hz)	F0' (Hz)	F2 (kHz)	F2' (kHz)	F3 (kHz)	F4 (Hz)																																		
2488.32 Mb/s	2 UI	—	100	—	100	20,000																																		
	32 UI	10	—	6.25	—	20,000																																		
Bit rate (Mb/s)	W (Ulp-p) <sup>*1</sup>		Y (Ulrms) <sup>*2</sup>																																					
	2 UI	20 UI	2 UI	20 UI																																				
2488 (CLK)	0.030	0.60	0.007	0.35																																				
2488 (optical)	0.100	2.20	0.027	0.55																																				
<p>Jitter transfer measurement</p>	<p>ITU-T G.958A, G.958B, user, Bellcore 253 [selectable bandwidth: ≤10 Hz (modulation frequency: ≥20 Hz)]</p>																																							
<p>Frequency measurement</p>	<p>2488.32 MHz ±100 ppm (resolution: 0.1 ppm)</p>																																							
<p>Hit measurement</p>	<p>Count, seconds, % free seconds</p>																																							
<p>Auxiliary interface</p>	<p>Reference, clock input</p>																																							
<p>Wander generator</p>	<p>Frequency: 2488.32 MHz                      Modulation frequency: 10 μHz to 200 mHz (sine wave)</p>  <table border="1" data-bbox="389 1757 1197 1840"> <thead> <tr> <th rowspan="2">Bit rate</th> <th colspan="3">Amplitude (Ulp-p)</th> <th colspan="6">Frequency (mHz)</th> </tr> <tr> <th>A0</th> <th>A1</th> <th>A2</th> <th>f0</th> <th>f1</th> <th>f2</th> <th>f3</th> <th>f4</th> <th>f5</th> </tr> </thead> <tbody> <tr> <td>2488M</td> <td>57,600</td> <td>6,480</td> <td>800</td> <td>0.01</td> <td>0.18</td> <td>1.6</td> <td>16</td> <td>130</td> <td>200</td> </tr> </tbody> </table>	Bit rate	Amplitude (Ulp-p)			Frequency (mHz)						A0	A1	A2	f0	f1	f2	f3	f4	f5	2488M	57,600	6,480	800	0.01	0.18	1.6	16	130	200										
Bit rate	Amplitude (Ulp-p)			Frequency (mHz)																																				
	A0	A1	A2	f0	f1	f2	f3	f4	f5																															
2488M	57,600	6,480	800	0.01	0.18	1.6	16	130	200																															

Wander measurement	<p>Frequency: 2488.32 MHz <math>\pm</math>50 ppm (Wander measurement becomes effective when MP0124A/0125A/0126A plus Option 02 is mounted.) Measurement frequency: Up to 10 Hz Measurement range P-P: 0.0 to 3.2E5 ns, +P/-P: 0.0 to 1.6E5 ns, TIE: 0.0 to <math>\pm</math>1.6E5 ns, MTIE/TDEV: 0.0 to 1.0E6 ns Auto-measurement: TIE, MTIE, TDEV (MTIE, TDEV: necessary for MX150001A application software)</p>
--------------------	--

• MP0123A ATM Unit

Bit rate	1.544, 2.048, 34.368, 44.736, 139.364, 51.840, 155.520, 622.080 Mb/s
Mapping	<p>The diagram illustrates the mapping process. On the left, a list of input rates is shown: STM-4c (optical), STM-1c (optical), STM-1c, STM-0, 139M (G.832), 34M (G.832), 2M (G.704), 45M (G.704), and 1.5M (G.704). These are grouped into two paths: SDH (receiving STM-4c, STM-1c, STM-0, 139M, 34M) and PDH (receiving 2M, 45M, 1.5M). On the right, the ATM/AAL services are listed: AAL1, AAL2, AAL3/4, and ATM. Lines indicate that SDH maps to AAL1, AAL2, and AAL3/4, while PDH maps to AAL1, AAL2, AAL3/4, and ATM.</p>
Traffic pattern	CBR, burst, sawtooth, PCR with CBR, Poisson
Test patterns	<p>Cell: Single cell PRBS 9, cross cell PRBS 9/15/23, 16-bit word pattern, edit pattern, time stamp O.191: Edit pattern AAL1: Single cell PRBS 9, cross cell PRBS 9/15/23, 16-bit word pattern, edit pattern, time stamp AAL2 (CPS-PDU): Time stamp AAL2 (CPS-PACKET): Single cell PRBS 7, 8-bit word pattern, edit pattern AAL3/4 (SAR-PDU): Time stamp AAL3/4 (CPCS-PDU): Single cell PRBS 9, cross cell PRBS 9/15/23, 16-bit word pattern, edit pattern AAL5: Single cell PRBS 9, cross cell PRBS 9/15/23, 16-bit word pattern, edit pattern</p>
Error addition	<p>Cell: HEC, programmable pattern O.191: Lost cell, misinserted cell, errored cell, SECB AAL1: Lost cell, SNP, PRBS, word AAL2 (CPS-PDU): P, SN, OSF AAL2 (CPS-PACKET): HEC, PRBS, word AAL3/4 (SAR-PDU): SN, CRC10, segment type, LI, abort AAL3/4 (CPCS-PDU): CPI, B/E tag mismatch, BA size, AL, length, PRBS, word AAL5: Frame size, length, CRC32, abort, PRBS, word</p>
Alarm addition	LCD, VP/VC AIS, VP/VC RDI, VP/VC CC, VP/VC loopback cell
PM cell	Error insertion: Lost cell, misinserted cell, BIPV, SECB
Cell editing	O.191, AAL1, AAL2, AAL3/4, AAL5, AIS, RDI, CC, loopback, FM, BR, background (10 ch)
Memorized cell	Possible to send after editing receiver's capture data
Measurement	<p>Mode: Single, repeat, manual Error Cell: Cell count, correctable HEC, uncorrectable HEC, non-conforming cell O.191: Errored cell, lost cell, misinserted cell, SECB AAL1: SAR-PDU count, lost cell, SNP, uncorrectable SNP, PRBS, word AAL2: CPS-PDU count, P, OSF, SN, CPS packet count, HEC, PRBS, word AAL3/4*: SAR-PDU count, CRC10, MID count (SAR-PDU with selected MID value), SN, ST (segment type), LI, abort, discarded PDU (one of SN error, LI error, abort, COM with ST error, or EOM with ST error), CPCS-PDU count, CPI, B/E tag mismatch, BA size, AL, length, undelivered PDU (one of CPI error, B/E tag mismatch, BA size error, AL error, or length error), PRBS, word *CRC10 is calculated for all SAR-PDU. The others are calculated for SAR-PDU with specified MID. AAL5: CPCS-PDU count, frame size, length, CRC32, abort, discarded PDU (one of frame size error, length error, CRC32 error, or abort), PRBS, word FM: Lost cell, misinserted cell, BIPV, SECB BR: Lost cell, misinserted cell, BIPV, SECB Alarm: LCD, VP/VC segment AIS, VP/VC end-to-end AIS, VP/VC segment RDI, VP/VC end-to-end RDI, VP/VC segment LOC, VP/VC end-to-end LOC</p>
LED	LCD, VP-AIS, VP-RDI, VP-LOC, VC-AIS, VC-RDI, VC-LOC, error
Monitor	Live monitor (1023 channel monitor), traffic monitor, cell monitor
Delay measurement	1-point CDV, 2-point CDV
Capture	1 to 2016 cells

● **MP0131A Add/Drop Unit**

Bit rate	1.544, 2.048, 34.368, 44.736, 139.264 Mb/s
Level/waveform	1.544 Mb/s: ANSI T1.102, 0/655 ft 44.736 Mb/s: ANSI T1.102, 0/450/900 ft (0 ft: Drop only) 2.048/34.368/139 Mb/s: ITU-T G.703
Connector	BANTAM (100 Ω, balanced): 1.544 Mb/s (AMI/B8ZS) 3-pin Siemens (120 Ω, balanced): 2.048 Mb/s (HDB3) BNC (75 Ω, unbalanced): 2.048 Mb/s, 34.368 Mb/s (HDB3), 139.264 Mb/s (CMI)
Mapping	See Fig. 2

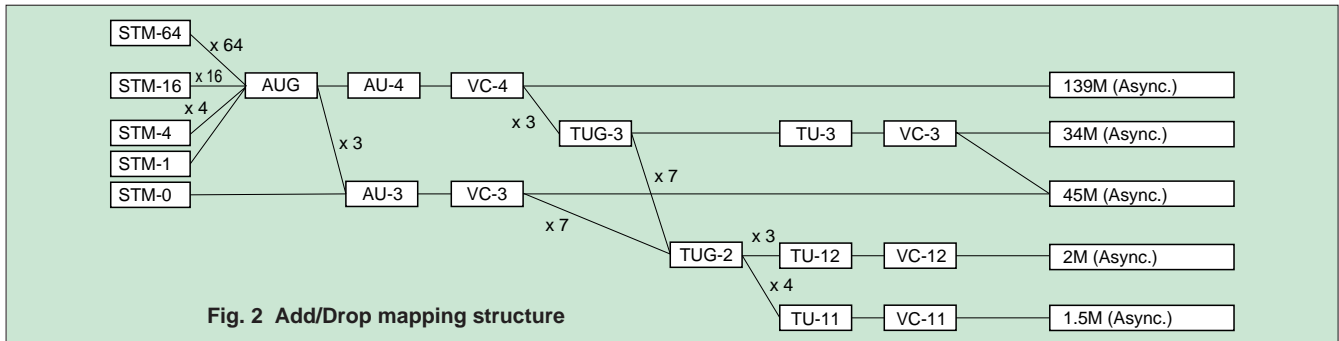

Fig. 2 Add/Drop mapping structure

● **MP0111A Optical 156M/622M (1.31) Unit**

Transmit	Bit rate: 155.520, 622.080 Mb/s (NRZ) Wavelength: 1310 nm Output level: -11.5 dBm ±3.5 dB Optical safety: IEC 825-1 Class 1, 21CFR1040.10 Class I Connector: FC-PC (SM-F)
Receive	Bit rate: 155.520, 622.080 Mb/s (NRZ) Sensitivity 156M: -33 to -8 dBm (test pattern: PRBS 2 <sup>23</sup> - 1, BER 10 <sup>-10</sup> , +10° to +40°C) 622M: -28 to -8 dBm (test pattern: PRBS 2 <sup>23</sup> - 1, BER 10 <sup>-10</sup> , +10° to +40°C) Connector: FC-PC (SM-F) Power measurement Measurement range: -30 to 0 dBm (peak power) Accuracy: ≤±1 dB (-20 dBm) Linearity: ≤±1 dB (-30 to 0 dBm)

● **MP0113A Optical 156M/622M (1.31/1.55) Unit**

Transmit	Bit rate: 155.520, 622.080 Mb/s (NRZ) Wavelength: 1310/1550 nm Output level 1.31 μm: -11.5 dBm ±3.5 dB, 1.55 μm: -5 dBm ±2 dB Optical safety: IEC825-1 Class 1, 21CFR1040.10 Class I Connector: FC-PC (SM-F)
Receive	Bit rate: 155.520, 622.080 Mb/s (NRZ) Sensitivity 156M: -33 to -8 dBm (test pattern: PRBS 2 <sup>23</sup> - 1, BER 10 <sup>-10</sup> , +10° to +40°C) 622M: -28 to -8 dBm (test pattern: PRBS 2 <sup>23</sup> - 1, BER 10 <sup>-10</sup> , +10° to +40°C) Connector: FC-PC (SM-F) Power measurement Measurement range: -30 to 0 dBm (peak power) Accuracy: ≤±1 dB (-20 dBm) Linearity: ≤±1 dB (-30 to 0 dBm)

● **MP0112A Optical 156M/622M (1.55) Unit**

Transmit	Bit rate: 155.520, 622.080 Mb/s (NRZ) Wavelength: 1550 nm Output level: -5 dBm ±2 dB Optical safety: IEC825-1 Class 1, 21CFR1040.10 Class I Connector: FC-PC (SM-F)
Receive	Bit rate: 155.520, 622.080 Mb/s (NRZ) Sensitivity 156M: -33 to -8 dBm (test pattern: PRBS 2 <sup>23</sup> - 1, BER 10 <sup>-10</sup> , +10° to +40°C) 622M: -28 to -8 dBm (test pattern: PRBS 2 <sup>23</sup> - 1, BER 10 <sup>-10</sup> , +10° to +40°C) Connector: FC-PC (SM-F) Power measurement Measurement range: -30 to 0 dBm (peak power) Accuracy: ≤±1 dB (-20 dBm) Linearity: ≤±1 dB (-30 to 0 dBm)

● **MP0122B 1.5/45/52/52 (1.31) Unit  
Optical interface**

Transmit	Bit rate: 51.84 Mb/s (NRZ) Wavelength: 1310 nm Output level: -11.5 dBm ±3.5 dB Optical safety: IEC 825-1 Class 1, 21CFR1040.10 Class I Connector: FC-PC (SM-F)
Receive	Bit rate: 51.84 Mb/s (NRZ) Sensitivity 52M: -33 to -8 dBm (test pattern: PRBS 2 <sup>23</sup> - 1, BER 10 <sup>-10</sup> , +10° to +40°C) Connector: FC-PC (SM-F) Power measurement Measurement range: -30 to 0 dBm (peak power) Accuracy: ≤±1 dB (-20 dBm) Linearity: ≤±1 dB (-30 to 0 dBm) Monitor input Level: 0.1 to 1.0 Vp-p (AC), Connector: SMA (50 Ω)

• **MU150008A/150009A/150010A 2.5G unit**

Bit rate	2488.32 Mb/s (NRZ)
Optical output	Wavelength: 1310 nm (MU150008A), 1550 nm (MU150009A), 1310/1550 nm (MU150010A) Output level: -4 dBm $\pm$ 3 dB Optical safety: IEC825-1 Class 3A, 21CFR1040.10 Class IIIb Connector: FC-PC (SM-F)
Optical input	Sensitivity Narrow: -28 to -9 dBm (BER $10^{-10}$ , +10° to +30°C), -27 to -9 dBm (BER $10^{-10}$ , 0° to +30°C) Wide: -20 to -9 dBm (BER $10^{-10}$ , +10° to +40°C) Connector: FC-PC (SM-F) Power measurement Range: -30 to -9 dBm (peak power) Accuracy: $\leq$ ±2 dB (-20 dBm) Linearity: $\leq$ ±2 dB (-30 to -9 dBm)
Electrical I/O	Transmit (NRZ) Level: ECL (-2 V), Connector (data, clock): SMA (50 $\Omega$ ) Receive (NRZ) Level: ECL (-2 V), Connector (data, clock): SMA (50 $\Omega$ ) Monitor input Level: 0.1 to 1.0 Vp-p (AC), Connector (data): SMA (50 $\Omega$ )
Auxiliary interface	External clock input, receive clock output, sync. output

• **MU150000A 2.5G/10G unit**

Bit rate	2488.320, 9953.28 Mb/s (NRZ)
Electrical I/O	Transmit (NRZ) Level: 0/-1 V $\pm$ 0.3 V Connector (data, clock): SMA (50 $\Omega$ ) Receive (NRZ) Level: 1 V(p-p) $\pm$ 0.3 V Connector (data, clock): SMA (50 $\Omega$ )
Auxiliary interface	External clock input, Internal clock output, receive clock output, 156M sync output, Error output

• **MP0105A CMI Unit**

Transmit	Bit rate: 155.520 Mb/s, Level: 1 $\pm$ 0.1 V, Connector: BNC (75 $\Omega$ )
Receive	Bit rate: 155.520 Mb/s Level: 1 $\pm$ 0.1 V (0 to 12 dB, with $\sqrt{f}$ auto correction and monitor function) Connector: BNC (75 $\Omega$ )

• **MU150001A/B Optical 10G Tx (1.55)**

Bit rate	9953.28 Mbit/s, 2488.320 Mb/s (Option 01, 02, 03)
Optical output	Wavelength: 1550 nm band, 1310 nm band (Option 01, 03) Output level: -4 dBm $\pm$ 3 dB Optical safety: IEC825-1 Class 3A, 21CFR1040.10 Class IIIb Connector: FC-PC (SMF)
Electrical input	Data input: 0/-1 $\pm$ 0.3 V Clock input: 0/-1 $\pm$ 0.3 V Connector: SMA 50 $\Omega$

• **MU150002A Optical 10G Rx (Narrow)**

Bit rate	9953.28 Mbit/s, 2488.320 Mb/s (Option 01)
Optical input	Sensitivity 10G: -13 to -3 dBm (BER $10^{-12}$ , NRZ, mark ratio 1/2, PRBS: $2^{31}-1$ ) 2.5G: -29 to -10 dBm (BER $10^{-11}$ , NRZ, mark ratio 1/2, PRBS: $2^{23}-1$ ) (Option 01) Connector: FC-PC (SMF) Power measurement Range: -16 to 0 dBm (10G, average power), -30 to -10 dBm (2.5G, average power) Accuracy: $\leq$ ±2 dB (10G, -10 dBm), $\leq$ ±2 dB (2.5G, -20 dBm) Linearity: $\leq$ ±2 dB (10G, -16 to 0 dBm), $\leq$ ±2 dB (2.5G, -30 to -10 dBm)
Electrical output	Data output: 1 $\pm$ 0.3 V(p-p) Clock output: 0.8 $\pm$ 0.2 V(p-p) (10G), 1 $\pm$ 0.3 V(p-p) (2.5G) Connector: SMA 50 $\Omega$

• **MP0108A NRZ Unit**

Transmit	Bit rate: 155.520, 622.080 Mb/s Level: ECL Connector (clock, data): SMA (50 $\Omega$ )
Receive	Bit rate: 155.520, 622.080 Mb/s Level: ECL (-2 V) Connector (clock, data): SMA (50 $\Omega$ )

# Typical Configuration

## 10G b/s Configuration

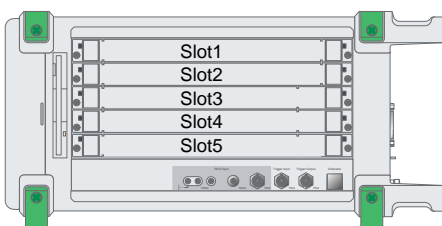

• **10G (Europe)**

- MP1570A Main frame
- Slot1:MP0121A 2/8/34/139/156M Unit
- Slot2:MU150002A Optical 10G Rx(Narrow) Unit
- Slot3:MU150001A Optical 10G Tx(1.55) Unit
- Slot4/5:MU150000A 2.5G/10G Unit
- Front:MP0113A Optical 156M/622M(1.31/1.55) Unit

• **10 G (North America)**

- MP1570A Main frame
- Slot1:MP0122A 1.5/45/52M Unit
- Slot2:MU150002A Optical 10G Rx(Narrow) Unit
- Slot3:MU150001A Optical 10G Tx(1.55) Unit
- Slot4/5:MU150000A 2.5G/10G Unit
- Front:MP0113A Optical 156M/622M(1.31/1.55) Unit

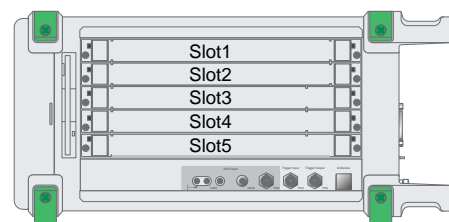



## 2.5G b/s Configuration

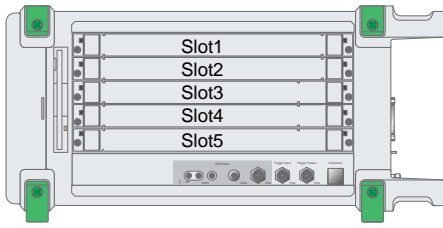

### • 2.5G (Europe)

MP1570A Main frame

Slot1:MP0121A 2/8/34/139/156M Unit

Slot2:MU150009A 2.5G(1.55) Unit

Slot3:

Slot4/5:

Front:MP0113A Optical 156M/622M(1.31/1.55) Unit

### • 2.5G (North America)

MP1570A Main frame

Slot1:MP0122A 1.5/45/52M Unit

Slot2: MU150009A 2.5G(1.55) Unit

Slot3:

Slot4/5:

Front:MP0113A Optical 156M/622M(1.31/1.55) Unit

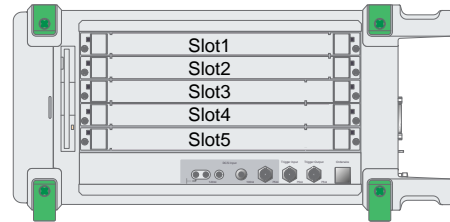

## 2.5G b/s Configuration Jitter measurement

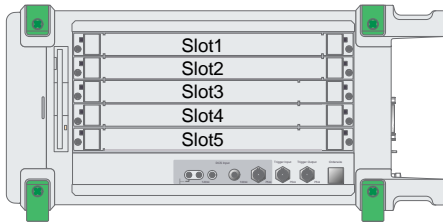

### • 2.5G (Europe)

MP1570A Main frame

Slot1:MP0121A 2/8/34/139/156M Unit

Slot2: MU150010A 2.5G(1.31/1.55) Unit

Slot3: MP0130A 2.5G Jitter Unit

Slot4/5:MP0124A 2/8/34/139M 156 /622M Unit

Front:MP0113A Optical 156M/622M(1.31/1.55) Unit

### • 2.5G (North America)

MP1570A Main frame

Slot1:MP0122A 1.5/45/52M Unit

Slot2: MU150010A 2.5G(1.31/1.55) Unit

Slot3: MP0130A 2.5G Jitter Unit

Slot4/5:MP0125A 1.5/45/52M 156/622M Jitter Unit

Front:MP0113A Optical 156M/622M(1.31/1.55) Unit

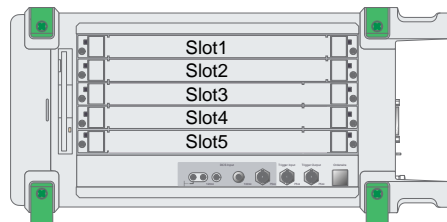

Unit	Slot 1	Slot 2	Slot 3	Slot 4/5
MP0121A 2/8/34/139/156M Unit	√			
MP0122A 1.5/45/52M Unit	√	√		
MP0122B 1.5/45/52/52M (1.31) Unit	√	√		
MP0123A ATM Unit			√	
MP0124A 2/8/34/139M, 156/622M Jitter Unit				√
MP0125A 1.5/45/52M, 156/622M Jitter Unit				√
MP0126A 2/8/34/139M, 1.5/45/52M, 156M/622M Jitter Unit				√
MU150008A 2.5G (1.31) Unit		√		
MU150009A 2.5G (1.55) Unit		√		
MU150010A 2.5G (1.31/1.55) Unit		√		
MP0130A 2.5G Jitter Unit			√	
MP0131A Add/Drop Unit	√	√		
MU150000A 2.5G/10G Unit				√
MU150001A/B Optical 10G Tx (1.55) Unit			√	
MU150002A Optical 10G Rx (Narrow) Unit		√		

# Ordering Information

Please specify the model/order number and quantity when ordering.

Model/Order No.	Name	Remarks
MP1570A	<b>Main frame</b> SONET/SDH/PDH/ATM Analyzer	
	<b>Standard accessories</b>	
Z0169	AC power cord:	1 pc
F0079	Printer paper (5 rolls/pack):	1 pack
B0329G	Fuse, 10 A:	2 pcs
J0907Q	Protective cover:	1 pc
J0908	Remote interlock cord:	1 pc
E0008A	Remote interlock terminator:	1 pc
J0747B	Optical output control key:	1 pc
J0747C	Fixed optical attenuator (10 dB):	1 pc
J0900A	Fixed optical attenuator (15 dB):	1 pc
W1719AE	Coaxial cable (AA-165-200), 20 cm:	2 pcs
W1720AE	MP1570A operation manual (Vol. 1 Basic operation for SDH):	1 copy
W1721AE	MP1570A operation manual (Vol. 2 Remote control):	1 copy
W1722AE	MP1570A operation manual (Vol. 3 ATM measurement):	1 copy
W1723AE	MP1570A operation manual (Vol. 4 2.5G/10G measurement):	1 copy
W1724AE	MP1570A operation manual (Vol. 5 Add/Drop function):	1 copy
W1725AE	MP1570A operation manual (Vol. 6 Jitter/wander measurement):	1 copy
W1726AE	MP1570A operation manual (Vol. 7 2.5G jitter/wander measurement):	1 copy
W1323AE	MX150001A wander (MTIE, TDEV) application software operation manual:	1 copy
J1002A	Semi-rigid cable:	2 pcs
J1002B	Semi-rigid cable:	2 pcs
J1002C	Semi-rigid cable:	3 pcs
	<b>Plug-in units</b>	
MP0121A	2/8/34/139/156M Unit	
MP0122A	1.5/45/52M Unit	
MP0122B*2	1.5/45/52/52M (1.31) Unit	
MP0123A	ATM Unit	
MP0124A	2/8/34/139M, 156/622M Jitter Unit	Only jitter generation/measurement, requires MP0121A
MP0125A	1.5/45/52M, 156/622M Jitter Unit	Only jitter generation/measurement, requires MP0122A/B
MP0126A	2/8/34/139M, 1.5/45/52M, 156/622M Jitter Unit	Only jitter generation/measurement, requires MP0121A or MP0122A/B
MU150008A*2	2.5G (1.31) Unit	With optical power meter
MU150009A*2	2.5G (1.55) Unit	With optical power meter
MU150010A*2	2.5G (1.31/1.55) Unit	With optical power meter
MP0130A	2.5G Jitter Unit	Only jitter generation/measurement, requires MU150008A, MU150009A, or MU150010A
MP0131A	Add/Drop Unit	
MU150000A	2.5G/10G Unit	
MU150001A*2	Optical 10G Tx (1.55) Unit	
MU150001B*2	Optical 10G Tx (1.55) Unit	
MU150002A*2	Optical 10G Rx (Narrow) Unit	With optical power meter
MP0111A*2	Optical 156M/622M (1.31) Unit	With optical power meter
MP0112A*2	Optical 156M/622M (1.55) Unit	With optical power meter
MP0113A*2	Optical 156M/622M (1.33/1.55) Unit	With optical power meter, 1.31/1.55 switchable
MP0105A	CMI Unit	
MP0108A	NRZ Unit	
	<b>Options</b>	
MP1570A-01	RS-232C	
MP1570A-02	GPIB	
MP1570A-03	Ethernet	
MP1570A-04*3	VGA output	
MP1570A-06	MUX/DEMUX (2/8/34/139 Mb/s)	For MP0121A
MP1570A-07	MUX/DEMUX (1.5/45 Mb/s)	For MP0122A/B
MP1570A-08	45M-2M MUX/DEMUX	Requires MP0121A and MP0122A/B
MP1570A-09	Japan mapping	Requires MP0122A or MP0122B
MP1570A-10*1	SDH	
MP1570A-11*1	SONET	
MP1570A-13	Frame memory capture (156M/622M)	
MP0124A-01	RMS measurement	
MP0125A-01	RMS measurement	
MP0126A-01	RMS measurement	
MP0130A-01	RMS measurement	
MP0124A-02	Wander measurement	
MP0125A-02	Wander measurement	
MP0126A-02	Wander measurement	
MU150008A-01	Frame memory capture (2.5G)	
MU150009A-01	Frame memory capture (2.5G)	
MU150010A-01	Frame memory capture (2.5G)	
MU150000A-01	Frame memory capture (2.5G/10G)	
MU150001A/B-01	2.5G (1.31)	
MU150001A/B-02	2.5G (1.55)	
MU150001A/B-03	2.5G (1.31/1.55)	
MU150002A-01	2.5G	

Model/Order No.	Name	Remarks
MP0111A/0112A-37	FC connector	Exchangeable 2 sets
MP0111A/0112A-38	ST connector	Exchangeable 2 sets
MP0111A/0112A-39	DIN connector	Exchangeable 2 sets
MP0111A/0112A-40	SC connector	Exchangeable 2 sets
MP0111A/0112A-43	HMS-10/A connector	Exchangeable 2 sets
MP0113A-37	FC connector	Exchangeable 3 sets
MP0113A-38	ST connector	Exchangeable 3 sets
MP0113A-39	DIN connector	Exchangeable 3 sets
MP0113A-40	SC connector	Exchangeable 3 sets
MP0113A-43	HMS-10/A connector	Exchangeable 3 sets
MP0122B-37	FC connector	Replaceable, 2 sets
MP0122B-38	ST connector	Replaceable, 2 sets
MP0122B-39	DIN connector	Replaceable, 2 sets
MP0122B-40	SC connector	Replaceable, 2 sets
MP0122B-43	HMS-10/A connector	Replaceable, 2 sets
MU150008A-37	FC connector	Replaceable, 2 sets
MU150008A-38	ST connector	Replaceable, 2 sets
MU150008A-39	DIN connector	Replaceable, 2 sets
MU150008A-40	SC connector	Replaceable, 2 sets
MU150008A-43	HMS-10/A connector	Replaceable, 2 sets
MU150009A-37	FC connector	Replaceable, 2 sets
MU150009A-38	ST connector	Replaceable, 2 sets
MU150009A-39	DIN connector	Replaceable, 2 sets
MU150009A-40	SC connector	Replaceable, 2 sets
MU150010A-43	HMS-10/A connector	Replaceable, 2 sets
MU150010A-37	FC connector	Replaceable, 2 sets
MU150010A-38	ST connector	Replaceable, 2 sets
MU150010A-39	DIN connector	Replaceable, 2 sets
MU150010A-40	SC connector	Replaceable, 2 sets
MU150010A-43	HMS-10/A connector	Replaceable, 2 sets
MU150001A/B-37	FC connector	Replaceable, 2 sets
MU150001A/B-38	ST connector	Replaceable, 2 sets
MU150001A/B-39	DIN connector	Replaceable, 2 sets
MU150001A/B-40	SC connector	Replaceable, 2 sets
MU150001A/B-43	HMS-10/A connector	Replaceable, 2 sets
MU150002A-37	FC connector	Replaceable, 2 sets
MU150002A-38	ST connector	Replaceable, 2 sets
MU150002A-39	DIN connector	Replaceable, 2 sets
MU150002A-40	SC connector	Replaceable, 2 sets
MU150002A-43	HMS-10/A connector	Replaceable, 2 sets
	<b>Application equipment</b>	
MP1777A	10 GHz Jitter Analyzer	
MP9766A	E/O, O/E Converter	
	<b>Optional accessories</b>	
MX150001A	Wander (MTIE, TDEV) Measurement Application Software	For MP0124A/0125A/0126A-02
J0796A	ST connector	Exchangeable, with protective caps, 1 set
J0796B	DIN connector	Exchangeable, with protective caps, 1 set
J0796C	SC connector	Exchangeable, with protective caps, 1 set
J0796D	HMS-10/A connector	Exchangeable, with protective caps, 1 set
J0796E	FC connector	Exchangeable, with protective caps, 1 set
J0162A	Balanced cable, 1 m	Siemens 3p-Siemens 3p
J0162B	Balanced cable, 2 m	Siemens 3p-Siemens 3p
J0845A	Balanced cable, 6 ft	BANTAM 3P/BANTAM 3P
J0775D	Coaxial cable (BNC-P620 • 3C-2WS • BNC-P620, 75 Ω), 2 m	
J0776D	Coaxial cable (BNC-P-3W • 3D-2W • BNC-P-3W, 50 Ω), 2 m	
J0398A	Conversion cable (M-1PS • BANTAM 3P), 1 m	
J0398B	Conversion cable (M-1PS • BANTAM 3P), 2 m	
J0635A	Optical fiber cable, 1 m	SM, FC-SPC connector both ends
J0635B	Optical fiber cable, 2 m	SM, FC-SPC connector both ends
J0635C	Optical fiber cable, 3 m	SM, FC-SPC connector both ends
J0747B	Fixed optical attenuator (10 dB)	
J0747C	Fixed optical attenuator (15 dB)	
J0747D	Fixed optical attenuator (20 dB)	
J0322B	Coaxial cable (11SMA • SUCOFLEX104 • 11SMA), 1 m	
J0008	GPIB cable, 2 m	
B0448	Soft case	
B0336C	Carrying case	

\*1: Must specify SDH (option 10) or SONET (option 11) when ordering depends on your system. The option price is included in the MP1570A.

These two options can be installed simultaneously. But in this case, one option price is charged.

\*2: Specify the connector to be supplied as the standard connector when ordering the above options.

If the connector is not specified the FC connector is supplied as standard.

\*3: The video output, RS-232C, GPIB and Ethernet options cannot all be used simultaneously.

Only the video output + RS-232C, or video output + GPIB, or RS-232C + GPIB board, or Ethernet board combinations support simultaneous use, so change the board combinations according to the purpose.



Specifications are subject to change without notice.

#### **ANRITSU CORPORATION**

5-10-27, Minamiazabu, Minato-ku, Tokyo 106-8570, Japan  
Phone: +81-3-3446-1111  
Telex: J34372  
Fax: +81-3-3442-0235

Overseas Subsidiaries

#### ● U.S.A.

#### **ANRITSU COMPANY**

#### **North American Region Headquarters**

1155 East Collins Blvd., Richardson, Tx 75081, U.S.A.  
Phone: +1-972-644-1777  
Fax: +1-972-644-3416

#### ● Canada

#### **ANRITSU ELECTRONICS LTD.**

Unit 102, 215 Stafford Road West  
Nepean, Ontario K2H 9C1, Canada  
Phone: +1-613-828-4090  
Fax: +1-613-828-5400

#### ● Brasil

#### **ANRITSU ELETRÔNICA LTDA.**

Praia de Botafogo 440, Sala 2401 CEP 22250-040,  
Rio de Janeiro, RJ, Brasil  
Phone: +55-21-5276922  
Fax: +55-21-537-1456

#### ● U.K.

#### **ANRITSU LTD.**

200 Capability Green, Luton, Bedfordshire LU1 3LU, U.K.  
Phone: +44-1582-433200  
Fax: +44-1582-731303

#### ● Germany

#### **ANRITSU GmbH**

Grafenberger Allee 54-56, 40237 Düsseldorf 1,  
Germany  
Phone: +49-211-96855-0  
Fax: +49-211-96855-55

#### ● France

#### **ANRITSU S.A.**

9, Avenue du Québec Z.A. de Courtabœuf 91951 Les  
Ulis Cedex, France  
Phone: +33-1-60-92-15-50  
Fax: +33-1-64-46-10-65

#### ● Italy

#### **ANRITSU S.p.A.**

Via Elio Vittorini, 129, 00144 Roma EUR, Italy  
Phone: +39-06-502-26-66  
Fax: +39-06-502-24-25

#### ● Sweden

#### **ANRITSU AB**

Botvid Center, Fittja Backe 1-3 145 84 Stockholm,  
Sweden  
Phone: +46-853470700  
Fax: +46-853470730

#### ● Singapore

#### **ANRITSU PTE LTD.**

6, New Industrial Rd., #06-01/02, Hoe Huat Industrial  
Building, Singapore 536199  
Phone: +65-282-2400  
Fax: +65-282-2533

#### ● Hong Kong

#### **ANRITSU COMPANY LTD.**

Suite 719, 7/F., Chinachem Golden Plaza, 77 Mody  
Road, Tsimshatsui East, Kowloon, Hong Kong, China  
Phone: +852-2301-4980  
Fax: +852-2301-3545

#### ● Korea

#### **ANRITSU CORPORATION**

14F Hyun Juk Bldg. 832-41, Yeoksam-dong,  
Kangnam-ku, Seoul, Korea  
Phone: +82-2-553-6603  
Fax: +82-2-553-6604~5

#### ● Australia

#### **ANRITSU PTY LTD.**

Unit 3/170 Forster Road Mt. Waverley, Victoria, 3149,  
Australia  
Phone: +61-3-9558-8177  
Fax: +61-3-9558-8255

#### ● Taiwan

#### **ANRITSU COMPANY INC.**

6F, 96, Sec. 3, Chien Kou North Rd. Taipei, Taiwan,  
R.O.C.  
Phone: +886-2-2515-6050  
Fax: +886-2-2509-5519