

# Datacom Products



Installation, Maintenance, Testing and Measurement



Datacom Products — Installation, Maintenance, Testing and Measurement

## Datacom Products



Installation, Maintenance, Testing and Measurement

# WELCOME TO TEMPO

Tempo is a new force in the installation and test and measurement of communications cabling networks. We are a collection of some of the strongest, most respected companies in the industry, each with a history rooted in success. Names like Progressive, Greenlee Data•Signal•Voice, RIFOCS and others, with expertise in designing, manufacturing and marketing some of the industry's most recognized installation and test equipment for the datacom market.

## DESIGNED FOR SUCCESS START TO FINISH

Tempo offers a complete line of innovative, rugged and practical datacom equipment to ensure a job done right. But we don't just sell products. We concept, design, engineer, manufacture and road-test the products that bear our name. And all our products are backed by service and support from a hands-on technical staff, many of whom are former industry professionals themselves. We take pride in the tools we make, because we have ownership in how they're made. It's the same pride we hope you'll feel when one of our products hangs from your belt — the pride in knowing you're part of a commitment to be the best.



**K N O W L E D G E . S O L U T I O N S . S U C C E S S .**

## CONTENTS

<b>Copper and Network Testers</b>	<b>2 - 11</b>
<b>Fiber Testers</b>	<b>12 - 33</b>
<b>Tones and Probes</b>	<b>34 - 43</b>
<b>Cable Locators</b>	<b>44 - 47</b>
<b>Kits</b>	<b>48 - 55</b>
Copper	<b>49 - 53</b>
Fiber	<b>54 - 55</b>
<b>Copper Tools</b>	<b>56 - 67</b>
Cutting	<b>57 - 58</b>
Stripping	<b>59 - 61</b>
Termination	<b>62</b>
Crimping	<b>63 - 67</b>
<b>Fiber Tools</b>	<b>68 - 73</b>
<b>Connectors</b>	<b>74 - 77</b>
<b>Installation Products</b>	<b>78 - 86</b>
<b>Index</b>	<b>87 - 90</b>



## Copper and Network Testers

PE900 Series Telephone Test Sets

MODEL NO.	PE930	PE940	PE945	PE950	PE961
Data Safe Monitor	●	●	●	●	●
Adjustable Ringer	●	●	●	●	●
Waterproof Design	●	●	●	●	●
Loud Speaker Listening		●	●	●	●
Two-way Hands Free			●		●
DigAlert™ Data Lock-out				●	●
ADSL Compatible					●



PE930



PE940



PE945



PE950



PE961

PE900 Series Telephone Test Sets



PE961



Features:

- Waterproof tested to an IEC IP67 rating, these test sets are so impervious to water they can actually withstand submersion
- The PE950 and PE961 feature our DigAlert over-voltage alarm and lock-out function to eliminate the danger of damaging or knocking out digital service lines
- The new PE961 provides full ADSL compatibility

Specifications:

- Ten-number speed dial memory (32 digits each)
- Last number redial
- Precise hook flash
- Microphone mute
- Audible and visual mode indicators
- Polarity test in any mode
- Unique quick-release belt clip
- Premium cordset with bed-of-nails and piercing pin clips

Description	Cat (UPC) No.	Description	Cat (UPC) No.
Test Set with Adjustable Ringer	PE930 (60487)	Test Set with Amplified Speaker and DigAlert	PE950 (60490)
Test Set with Amplified Speaker	PE940 (60488)	Test Set with Two-way Hands Free and DigAlert	PE961 (60511)
Test Set with Two-way Hands Free	PE945 (60489)	Ground Start Cordset	PE901 (60492)
		Replacement Cordset	PE902 (60493)



PE810

Tele-Mate Communication Test Set

Application:

Designed for communications wiring installation and repair to quickly verify the quality of a new installation.

Features:

- Affordable
- Headset for hands-free operation
- Rugged design for demanding use
- Compact design and durable belt clip make it easy to carry

Specifications:

- Adjustable volume
- Built-in ringer
- Tone/Pulse dialing
- Last number redial
- Line polarity indication
- Microphone mute
- Data safe monitor mode
- Replaceable premium cordset with telco-style clips

Description	Cat (UPC) No.
Tele-Mate Communication Test Set	PE810 (60298)



PE290-00

PE290-01

PE290-02

PE290-04

P-Phone Adapters

Application:

Enables analog telephone test sets to be used on POTS or Meridian Digital Centrex lines with the use of a simple slide switch.

Specifications:

- Connects directly to most analog test sets
- PE290-01, PE290-02 and PE290-04 feature angled bed-of-nails clips and piercing spike

Description	Cat (UPC) No.
Hard-wired P-Phone Adapter	PE290-00 (60494)
Hard-wired P-Phone Adapter with 5' OSP Cordset	PE290-01 (60495)
Hard-wired P-Phone Adapter with 5' Combi-cord	PE290-02 (60515)
Clip-to P-Phone Adapter with 5' OSP Cordset	PE290-04 (60496)

Harrier ISDN Test Set

Application:

Use as an ISDN telephone or perform self-call or end-to-end B channel Bit Error Rate tests and D channel packet access tests.

Features:

- Keypad and liquid crystal display are positioned to face the user
- Control keys are placed in the handle for easy access
- Ergonomically designed, the PE310 fits comfortably in the hand and rests easily on the shoulder
- Highly water resistant

Specifications:

- Backlit LCD shows test menus, call setup, call progress, layer 1, 2 and 3 error messages, ISDN call clear cause codes and test information
- Rechargeable nickel-metal-hydride (NiMH) battery allows 1 to 2 hours of operation
- AC adapter recharges the battery while in use
- Replacing the NiMH battery with a standard 9V battery will allow 6 to 8 hours of continued use

Description	Cat (UPC) No.
Harrier ISDN Test Set w/POTS	PE310 (60499)



PE310



### TurTEL Modular Adapters/Polarity Tester



46040

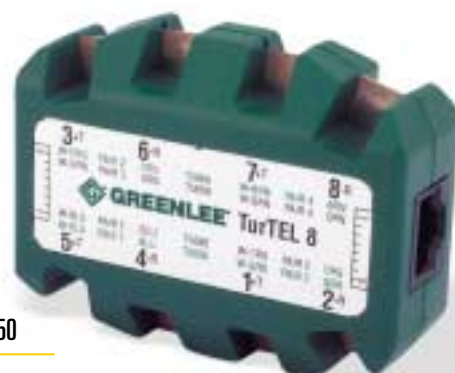

46050

**Application:**

Use with tone generators, test sets and other test devices to troubleshoot and isolate problems with telephone circuits.

**Features:**

- Two jacks allow in-line testing without service interruption
- The TurTEL 6 has two six-position, six-wire jacks
- The TurTEL 8 has two eight-position, eight-wire jacks
- Simple, push button operation to check polarity and power
- Reduced chance of shorting adjacent alligator clips due to unique shape
- Test contacts are perforated to provide sure grip for alligator clips or use of probes

**Specifications:**

- The TurTEL 6 has an internal circuit to allow testing of polarity for either of two lines (pairs 4 to 5 or 3 to 6) — circuit allows verification of power and phone number assignments
- Patch cord included
- Heavy-duty stainless steel belt clip

Description	Cat (UPC) No.
TurTEL 6 Modular Adapter/Polarity Tester	46040
TurTEL 8 Modular Adapter	46050

### T-Bug® Digital Signal Identifier



134A

**Application:**

Used to detect digital signals on twisted pair cables, identify and isolate digital pairs for special handling and help technicians avoid accidentally putting pairs out of service.

**Features:**

- Operation is non-invasive and does not involve metallic contact so there's no risk of service interruption
- Simple to use — just place the probe between the pairs in question

- Differential amplifier saves time by allowing the technician to determine whether the signal is truly present or is an induced signal from adjacent pairs
- False readings due to noise are virtually eliminated
- Continuous self test ensures that the unit is functioning properly

**Specifications:**

- Emits both visible and audible indication when digital signals are present

Description	Cat (UPC) No.
T-Bug Digital Signal Identifier	134A (60764)

### Voice Tagger Plus



1185-5011

**Application:**

Uses voice response and tone generator technology to identify and tag twisted pair, coax cable, electrical wires and security/alarm wires.

**Features:**

- Single setup for easy operation
- Test leads clearly marked
- Lightweight yet rugged construction is both portable and durable

**Specifications:**

- Nine test leads
- Traces and identifies 17 separate pairs/conductors
- Requires two units for a single setup or two simple setups for one unit
- Voice response and tone output
- Toning and tagging up to 50,000'

Description	Cat (UPC) No.
Voice Tagger Plus	1185-5011 (60519)

### Coaxial Cable Tester



45055

**Application:**

Provides quick verification of opens or shorts in either the conductor or the shield of coax cable.

**Features:**

- Simple one-button operation provides pass/fail indication
- Remote terminator allows testing of cables before or after installation

**Specifications:**

- Clear red/green LED indication of short or open conditions
- Standard BNC- and F-type female connectors
- Battery operated (9V included)

Description	Cat (UPC) No.
Coaxial Cable Tester	45055

### Sure Signal™

**Application:**

Designed for cable installers and communications technicians for testing four-pair data/voice cable links terminated with standard, modular eight-position RJ45-style jacks.

**Features:**

- Simplest tester available for identifying common wiring faults such as shorts, opens and miswires
- Diagnosis can be completed at one end
- Sequentially lighting LEDs corresponding to each wire allow easier diagnosis of miswires than testers that check pairs
- Can test more wiring configurations than other testers due to sequential wiremap testing

- Shielded test ports allow extra versatility to test shielded and screened twisted pair
- Optional patch cords allow the Sure Signal to be used as a coax tester, eliminating the need for a second tester

**Specifications:**

- Optional remote unit can be used to check patch cords for wiring errors
- Optional Accessory Kit includes two RJ45 patch cords, two RJ45 to BNC adapter cords, two RJ45 to RJ11 snap-in adapters and one BNC plug to BNC plug adapter
- Battery operated (9V not included)



46060

Description	Cat (UPC) No.
Sure Signal Line Verifier and Patch Cord Tester	46060
Sure Signal Remote	46070
Carrying Case	45276
Sure Signal Accessory Kit	46065

### Modular Cable Tester/Tone Generator

**Application:**

Quickly identifies opens, shorts, reversals and transposed pairs.

**Features:**

- Economical tester includes all the basic functions
- Connecting the receiver unit automatically activates the test process
- Sequencing red and green LEDs provide fast, accurate and simple-to-understand results
- Alerts the technician if connected to an active circuit without harming the unit

**Specifications:**

- Connect any eight-position modular plug to the appropriate jack on the transmitter and a sweeping tone signal is applied to all pairs
- At the far end of the cable, use any Tempo inductive amplifier (probe) to locate the corresponding plug or jack
- Battery operated (9V not included)



468

Description	Cat (UPC) No.
Modular Cable Tester/Tone Generator	468 (08661)
Carrying Case for the Modular Cable Tester/Tone Generator	468C (60382)



45280

### PairMapper™ Twisted Pair Fault Tester

**Application:**

Use to identify various wiring faults found in 10BASE-T and other four-pair, unshielded twisted pair (UTP) cables per TIA/EIA 568A and 568B.

**Features:**

- Tests and identifies up to four cables with unique Remote Terminators
- Easy-to-use, compact

**Specifications:**

- Tests four-pair UTP cables including 100 BASE T
- Checks UTP cable for shorts, opens, crossed pairs, reversed pairs and split pairs
- Battery operated (9V not included)

Description	Cat (UPC) No.
PairMapper Twisted Pair Fault Tester with Remote 1	45280
Remote Terminators 2, 3, 4	45275
Carrying Case	45276

### PROSCANNER™ Network Cable Test Kit

**Application:**

Designed to check cabling integrity and confirm length, wiring configuration and the location of cable faults.

**Features:**

- Affordable
- Pocket-sized
- Uses TDR technology to ensure accurate length measurements
- Enables patch cable testing without couplets or external adapters

**Specifications:**

- Checks wire continuity
- Checks wire configuration (wiremap)
- Pinpoints opens, shorts, crossed and split pairs
- Measures length, including individual pairs to the hub
- Tone feature locates remote cable ends and cables in a bundle
- Matches cables to offices during additions, moves and changes
- Battery operated (9V not included)
- Kit includes the PROSCANNER Network Cable Test Unit and Wiremap Adapter #4 in a convenient carrying case



PE-K01

Description	Cat (UPC) No.
PROSCANNER Network Cable Test Kit	PE-K01 (08697)
PROSCANNER Master Unit Only	PE-P01 (08699)
Carrying Case	PE-C01 (08696)

### Office Identifier Kit

**Application:**

Identifies cable links from the wiring closet to the office.

**Specifications:**

- Maximum length 656 ft (200 m)
- Optional cord improves tone signal strength for identifying longer cable runs or tracing wires within walls



PE-K02

Description	Cat (UPC) No.
Office Identifier Kit	PE-K02 (08698)
Grounding Cord Assembly	PE-P03 (08701)



52397

### NETcat® LAN Trouble Shooter

**Application:**

Tests and maintains 10BASE-T and coaxial Ethernet networks consisting of CAT 3, 4 and 5 cable. Tests include WireMap, TDR length, near-end crosstalk (NEXT) and attenuation to 16MHz, signal-to-noise ratio and noise.

**Features:**

- Diagnoses many common network problems with its combination of cable testing and network monitoring
- Autotest function automatically performs critical cable tests and reports PASS or FAIL, along with cause for any failure

**Specifications:**

- Detects active Ethernet traffic
- Monitors Ethernet traffic for utilization, collisions, hub link pulse and jabber
- Battery operated (three 9V batteries included)

Description	Cat (UPC) No.
NETcat LAN Trouble Shooter	52397
Vinyl Carrying Case	55412
Token Ring Adapter	52404

### NETcat Plus LAN Trouble Shooter

**Application:**

Tests and maintains CAT 3, 4 and 5 Ethernet, 10BASE-T and Token Ring networks. Tests include WireMap, TDR length, near-end crosstalk (NEXT) and attenuation to 20MHz and noise.

**Features:**

- Diagnoses many common network problems with its combination of cable testing and Ethernet network monitoring
- Autotest function automatically performs critical cable tests and reports PASS or FAIL, along with cause for any failure
- Stores and prints up to 500 autotest reports

**Specifications:**

- Verifies network moves, adds and changes
- Identifies distance to any cable damage
- Detects active Ethernet traffic
- Monitors Ethernet traffic for utilization, collisions, hub link pulse and jabber
- Datalogs Ethernet traffic up to 30 hours
- Includes batteries, AC/mains adapter, printer cable and system carrying case
- Operates from batteries or AC/mains adapter

Description	Cat (UPC) No.
NETcat Plus LAN Trouble Shooter	54801
Token Ring Adapter	52404



54801

### LANcat® System 5 and System 6 Network Cable Tester & Talk Set



54713 System 5



**Application:**

Certifies up to 100MHz Category 5/Class D twisted pair cabling.

**Specifications:**

- System 5 Autotest Suite includes Power Sum NEXT, Attenuation, Power Sum ACR, Length, WireMap, Propagation Delay, Delay Skew and headroom margin
- System 6 Autotest Suite includes Power Sum NEXT, Attenuation, EL-FEXT, Return Loss, Length, WireMap, Propagation Delay and Delay Skew.
- Built-in two-way talk set
- Cable toner for locating cable ends
- Fiberoptic cable testing options
- Save up to 800 autotest reports for upload to a PC using provided Windows-based software
- Operates from AA cells, AC/mains adapter or optional NiMH battery pack
- Includes hard carrying case

Description	Cat (UPC) No.
LANcat System 5 (115V, 60Hz)	54713
LANcat System 6 (115V, 60Hz)	54784

**LANcat System Accessories:**

NiMH Rechargeable Battery Pack	54459
Coax Cable Testing Module Option	54458
110 Block Connecting Module Option (T568A wired)*	54655
110 Block Connecting Module Option (T568B wired)*	54657
Handset Cover for LANcat System 5 Handsets	54741
Installers Kit (NiMH battery packs (2), System 5 Handset covers (2))	54742

\*Category 5/Class D testing



54784 System 6



**Application:**

Certifies up to CAT5 and Enhanced CAT5 twisted pair cabling to the most demanding TIA Category 5e Level IIe requirements.

**FIBERcat® Test & Talk**

The FIBERcat Test & Talk converts your LANcat System into a multimode optical loss test set. See page 11 for details.

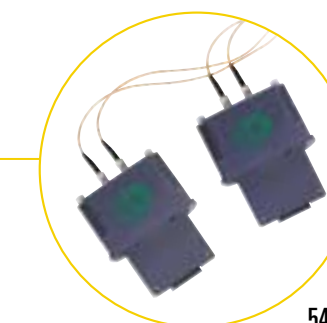

54869



## FIBERcat® Test & Talk Fiber Certification System



54869

### Application:

Converts any LANcat® System 5 or System 6 into a precision multimode optical loss test set.

### Features:

- Measures dual wavelength, bi-directional multimode 850/1300nm optical loss and link length on two cables simultaneously
- Includes automated link loss budget calculation and automatic PASS/FAIL determination

### Specifications:

- Tests two fibers with one autotest
- Measures link length and propagation delay
- Saves up to 800 autotest reports in LANcat handsets for upload to a PC using provided Windows-based software
- Talk over multimode fiber
- Optional ST Fiber Test Kit includes two ST simplex launch cables 62.5/125µ, two ST bulkhead adapters and alcohol pads

Description	Cat (UPC) No.
FIBERcat Test & Talk	54869
LANcat System 6 w/ Test & Talk	54872
ST Fiber Test Kit	54720
ST to ST Simplex Patch Cable (62.5/125µ)	54870
ST to SC Simplex Patch Cable (62.5/125µ)	54871

## FIBERcat Optical Loss Test Kit



54653

Handset not included

### Application:

Converts any LANcat System 5 or System 6 handset into a precision optical power meter for measuring fiberoptic power or cable loss.

### Specifications:

- Measures 850/1300nm optical loss on multimode fiber
- Measures 1310/1550nm optical loss on single-mode fiber
- Includes 850/1300nm LED light source
- Memory for multiple loss references
- Saves up to 400 autotest reports in LANcat handsets for upload to a PC using provided Windows-based software
- Optional ST Fiber Test Kit includes two ST simplex launch cables 62.5/125µ, two ST bulkhead adapters and alcohol pads

Description	Cat (UPC) No.
FIBERcat Optical Loss Test Kit	54653
ST Fiber Test Kit	54720
ST to ST Simplex Patch Cable (62.5/125µ)	54870
ST to SC Simplex Patch Cable (62.5/125µ)	54871



Fiber Testers

### Quick Reference Charts for Fiber Testing Applications

#### Fiber Optic Measurements Matrix

APPLICATION	SINGLE-MODE	PAGE NO.	MULTIMODE (glass fiber)	PAGE NO.
Visual Fault Location	T160L / T164L / T165L 263LX + FoPro®	22, 23 23, 32	T160L / T164L / T165L 263LX + FoPro	22, 23 23, 32
Visual Continuity	T160L / T164L / T165L 263LX	22, 23 23	T160L / T164L / T165L 263LX	22, 23 23
Measure Optical Power (to +3dBm) (to +27dBm)	522B / 555B 522B-HP / 558B	19, 20 19, 21	522B / 555B / 557B	19, 20, 21
Measure Insertion Loss / Attenuation (Dual Wavelength)	262A + 555B 10,000 Series / 11,000 Series 523B-13/15	20 27, 16 15	252B + 555B 5,000 Series / 6,000 Series FiberMeter™	25, 20 17 14
Data Storage Capability	522B / 522B-HP 523B-13/15	19 15	522B / 522B-HP	19

#### Special Test Equipment for MT-RJ Interconnections

APPLICATION	SINGLE-MODE	PAGE NO.	MULTIMODE (glass fiber)	PAGE NO.
Visual Fault Location	263MT	23	263MT	23
Visual Continuity	263MT	23	263MT	23
Measure Optical Power	556MT	20	556MT	20
Measure Insertion Loss	262A + 556MT	27, 20	255MT / 257MT + 556MT 5,000 Series / 6,000 Series 60576MT / 60556MT	26, 20 17 18

#### Special Test Equipment for Plastic Optical Fiber (POF)

APPLICATION	MULTIMODE (1 mm POF)	PAGE NO.
Visual Fault Location	253B	26
Visual Continuity	253B	26
Measure Optical Power	557B	21
Measure Insertion Loss	253B + 557B	21 26

NOTE: Typical POF Connectors include Versatile Link, J/V/Z Pins and TOSLINK.  
See SOC adapter selection guide on pages 29 and 30.

### FiberMeter Fiber Certification System

#### Application:

A complete system for field testing of premise wiring fiber links on multimode fiber per TIA-568B.3.

#### Features:

Multimode fiber testing features:

- Accommodates both 50/125 and 62.5/125 multimode fiber
- Test two multimode fibers with one setup
- Automated measurement of optical loss and cable length
- PASS/FAIL certification against industry standards
- Detailed certification reports
- Built-in talk set
- Fixed ST-PC interface (use hybrid reference cables for other connector types)

#### Specifications:

- Measurement range +3 to -55dBm
- Measure bi-directional loss at 850/1300nm
- Measure link length to 2000 meters
- Saves up to 2000 link reports for upload to a PC using provided Windows-based software
- Operates from AA cells, AC/mains or optional NiMH rechargeable battery packs
- System includes thermoform handset covers, four test jumpers, earphones, AA batteries, AC/mains adapters and a carrying case



Description	Cat (UPC) No.
FiberMeter Fiber Certification System 115V	55430

55430

Optical Loss Test Sets

MODEL NO.	FiberMeter™	523B-13/15	10,000 & 11,000 Series	5,000 & 6,000 Series	60556MT	253B+557B
PACKAGE	Handheld	Handheld	Handheld	Palm-sized	Palm-sized	Palm-sized
SOURCE TYPE	LED	Laser	Laser	LED	LED	LED
CALIBRATION WAVELENGTHS (nm)	350/1300	1310/1550	1310/1550	850/1300	850/1300	650
MEASUREMENT RANGE	+3 to -5dBm	+3 to -75dBm	+3 to -60dBm	+3 to -60dBm	+3 to -60dBm	+3 to -60dBm
MEASUREMENT UNITS	dB, dBm	dB, dBm, W	dB, dBm	dB, dBm	dB, dBm	dB, dBm
Storage Capability	●	●				
Single-mode		●	●			
Multimode (glass)	●			●	●	
Multimode (POF)						●
Talk Function	●					



55430



523B-13/15



10520K



6052B2K



60556MT



253B+557B

Advanced Single-mode Optical Loss Test Set

Application:

Incorporates a stable dual 1310nm/1550nm laser source and optical power meter in a convenient self-contained package to perform insertion loss and link loss testing.

Features:

- Large, backlit LCD display makes it easy to view power levels and calibration wavelengths
- Operation is simple due to the user-friendly keypad and intuitive controls
- Remote operation permits the automation of tedious or repetitive measurements
- Rubber boot protects against dropping and crushing
- Rugged and splashproof

Specifications:

- Indium-gallium-arsenide (InGaAs) photodetector
- 1310/1550nm dual laser source
- +3dBm to -75dBm measurement range
- PASS/FAIL testing with audible signal
- Manual or timer-driven data logging for periods from one second to one hour
- Data storage for 1,000 measurements
- RS232 interface for instrument configuration and data transfer to a PC-compatible workstation or serial printer
- Powered by a rechargeable nickel-metal hydride (NiMH) battery pack, four alkaline batteries or AC adapter
- Built-in NiMH battery charger with external power supply

Requires one SOC and one UCI connector adapter (See pages 29 and 30). Source output is directly compatible with PC connectors. For APC use hybrid cable approach (See page 33).



523B-13/15

Description	Cat (UPC) No.
Advanced Single-mode Optical Loss Test Set	523B-13/15 (60550)

fiberTOOLS® Single-mode Optical Loss Test Sets

Application:

These conveniently packaged test sets are used to test, troubleshoot and maintain telco, CATV, LAN and other single-mode network applications. The Basic Set can be used to measure output power and certify end-to-end attenuation on deployed fiber spans.

Features:

- Easy-to-use, all-in-one prepackaged kit
- Dual wavelength 1310/1550nm source covers all requirements
- Source has stable, calibrated output
- Rugged, splashproof instruments
- Water- and air-tight hard carrying case

Specifications:

- Meet the link certification requirements of TIA-568B and ISO/IEC-11801
- 0.01dB measurement resolution
- Two AA batteries provide power for over 100 hours in the optical power meters, over 50 hours in the LED sources and over 48 hours in the visual fault finder

Basic Sets include:

- 555B Optical Power Meter plus adapter
- 262A Dual Wavelength 1310/1550nm Laser Source plus adapters
- Reference cable
- Connector cleaner
- Cleaning wands
- Hard carrying case (900B)

Deluxe Sets include:

- Basic Set contents
- Visual fault finder (T164L — 1.25 mm or T165L — 2.5 mm as applicable)



10520K



To accommodate other connector types, see our SOC/UCI adapters on pages 29 and 30 and reference cables on page 33.

Description	Cat (UPC) No.
<b>Basic Single-mode Test Sets:</b>	
Basic SM Test Set, E2000-PC	10520E2 (60611)
Basic SM Test Set, FC-PC	10520K (60608)
Basic SM Test Set, ST-PC	105203K (60609)
Basic SM Test Set, SC-PC	105206K (60610)
Basic SM Test Set, LC-PC	10520LC (60612)
Basic SM Test Set, MU-PC	10520MU (60613)
<b>Deluxe Single-mode Test Sets:</b>	
Deluxe SM Test Set, E2000-PC	11520E2 (60618)
Deluxe SM Test Set, FC-PC	11520K (60615)
Deluxe SM Test Set, ST-PC	115203K (60616)
Deluxe SM Test Set, SC-PC	115206K (60617)
Deluxe SM Test Set, LC-PC	11520LC (60619)
Deluxe SM Test Set, MU-PC	11520MU (60620)
AC/Main Power Converter 120V (one required per handheld unit)	90ACK (60686)

### fiberTOOLS® Multimode Optical Loss Test Sets

**Application:**

These conveniently packaged test sets are used to test, troubleshoot and maintain LAN and other network applications.

**Features:**

- Easy-to-use, all-in-one prepackaged kit
- Dual wavelength 850/1300nm LED source(s) covers all requirements
- Rugged, splashproof instruments
- Water- and air-tight hard carrying case

**Specifications:**

- Meet the link certification requirements of TIA-568B and ISO/IEC-11801
- 0.01dB measurement resolution
- Two AA batteries provide power for over 100 hours in the optical power meters, over 24 hours in the LED sources and over 48 hours in the visual fault finder

**Basic Sets include:**

- 555B Optical Power Meter plus adapter
- 252B Dual Wavelength 850/1300nm LED Source plus 2x adapters
- Reference cable
- Mating adapter
- Connector cleaner
- Cleaning wands
- Hard carrying case (900B)

**Basic MTRJ Test Sets include:**

- 556MT Optical Power Meter plus adapter
- 255MT 1300nm MT-RJ Source
- 257MT 850nm LED MT-RJ Source
- Reference cable
- Mating adapter
- Connector cleaner
- Cleaning wands
- Hard carrying case (900B)

**Deluxe Sets include:**

- Basic Set contents
- Visual fault finder (T164L — 1.25 mm or T165L — 2.5 mm or 263MT for MTRJ, as applicable)



6052B2K

Description	Cat (UPC) No.	Cat (UPC) No.	Description	Cat (UPC) No.	Cat (UPC) No.
<b>Basic Multimode Test Sets:</b>	<b>50/125</b>	<b>62.5/125</b>	<b>Deluxe Multimode Test Sets:</b>	<b>50/125</b>	<b>62.5/125</b>
Basic MM Test Set, E2000-PC	5052BE2 (60627)	6052BE2 (60643)	Deluxe MM Test Set, E2000-PC	5152BE2 (60635)	6152BE2 (60651)
Basic MM Test Set, FC-PC	5052B2K (60624)	6052B2K (60640)	Deluxe MM Test Set, FC-PC	5152B2K (60632)	6152B2K (60648)
Basic MM Test Set, ST-PC	5052B3K (60625)	6052B3K (60641)	Deluxe MM Test Set, ST-PC	5152B3K (60633)	6152B3K (60649)
Basic MM Test Set, SC-PC	5052B6K (60626)	6052B6K (60642)	Deluxe MM Test Set, SC-PC	5152B6K (60634)	6012B6K (60650)
Basic MM Test Set, LC-PC	5052BLC (60628)	6052BLC (60644)	Deluxe MM Test Set, LC-PC	5152BLC (60636)	6152BLC (60652)
Basic MM Test Set, MU-PC	5052BMU (60629)	6052BMU (60645)	Deluxe MM Test Set, MU-PC	5152BMU (60637)	6152BMU (60653)
Basic MM Test Set, MT-RJ	5062FMT (60630)	6062FMT (60646)	Deluxe MM Test Set, MT-RJ	5162FMT (60638)	6162FMT (60654)
AC/Main Power Converter 120V (one required per handheld unit)	90ACK (60686)	90ACK (60686)	AC/Main Power Converter 120V (one required per handheld unit)	90ACK (60686)	90ACK (60686)

### fiberTOOLS MT-RJ Optical Loss Test Sets

**Application:**

Our MT-RJ Test Sets provide all the equipment required to test, troubleshoot and certify multimode optical links.

**Features:**

- Easy-to-use, all-in-one prepackaged kit
- Both 850 and 1300nm LED sources available
- Rugged, splashproof instruments
- Conveniently packaged in a water- and air-tight hard case (Deluxe Set only)

**Specifications:**

- Meet the link certification requirements of TIA-568B and ISO/IEC-11801
- 0.01dB measurement resolution
- Two AA batteries provide power for over 100 hours in the optical power meters, over 24 hours in the LED sources and over 48 hours in the visual fault finder

**Single Wavelength Test Sets include:**

- 556MT Optical Power Meter plus MT-RJ adapter
- 255MT (1300nm) or 257MT (850nm) LED Source
- 62.5/125 Reference Cable Set
- Mating adapter
- Soft carrying case (911B)

**Dual Wavelength Basic Test Sets include:**

- 556MT Optical Power Meter plus MT-RJ adapter
- 255MT 1300nm MT-RJ LED Sources
- 257MT 850nm MT-RJ LED Sources
- MT-RJ Reference Cable Set
- MT-RJ Mating Adapter
- Universal connector cleaner
- Hard carrying case (900B)

**Dual Wavelength Deluxe Test Sets include:**

- Basic Set contents
- 263MT MT-RJ Visual Fault Finder



60556MT



To accommodate other connector types, see our SOC/UCI adapters on pages 29 and 30 and reference cables on page 33.

Description	Cat (UPC) No.	Cat (UPC) No.
<b>Single Wavelength MT-RJ Test Sets:</b>	<b>50/125</b>	<b>62.5/125</b>
MM Test Set, 1300nm	N/A	60556MT (60555)
MM Test Set, 850nm	N/A	60576MT (60727)
<b>Dual Wavelength 850/1300nm MT-RJ Test Sets:</b>	<b>50/125</b>	<b>62.5/125</b>
Basic MM Test Set, 850/1300nm	5062FMT (60630)	6062FMT (60646)
Deluxe MM Test Set, 850/1300nm	5162FMT (60638)	6162FMT (60654)
AC/Main Power Converter 120V (one required per handheld unit)	90ACK (60686)	90ACK (60686)

Optical Power Meters

MODEL	522B	522B-HP	555B	556MT	557B	558B
PACKAGE	Handheld	Handheld	Palm-sized	Palm-sized	Palm-sized	Palm-sized
DETECTOR TYPE	1 mm InGaAs	Filtered 2 mm InGaAs	1 mm InGaAs	3 mm Ge	3 x 3.5 mm Silicon	Filtered 2 mm InGaAs
CALIBRATION WAVELENGTHS (nm)	850/980/1310/ 1480/1550/1625	850/980/1310/ 1480/1550/1625	850/1300/1310/1550	850/1300/1550	635/780/850	980/1310/1550
MEASUREMENT RANGE	+3 to -75dBm	+27 to -53dBm	+3 to -60dBm	+3 to -40dBm	+3 to -60dBm	+27 to -30dBm
MEASUREMENT UNITS	dB, dBm, mW	dB, dBm, mW	dB, dBm	dB, dBm	dB, dBm	dB, dBm
OPTICAL POWER METER INTERFACE TYPE	SOC Universal	SOC Universal	SOC Universal	SOC Universal	SOC Universal	SOC Universal
User-selectable Auto Shutoff	●	●	●	●	●	●
Storage Capability	●	●				



522B



522B-HP



555B



556MT



557B



558B

Advanced Optical Power Meters



522B

Application:

Designed for insertion loss and link loss measurements using an external light source.

Features:

- Large, backlit LCD display makes it easy to view power levels and calibration wavelengths
- Operation is simple due to the user-friendly keypad and intuitive controls
- Remote operation permits the automation of tedious or repetitive measurements
- Rubber boot protects against dropping and crushing
- Rugged and splashproof

Specifications:

- 850nm, 980nm, 1310nm, 1480nm, 1550nm and 1625nm calibration wavelengths
- InGaAs photodetector
- +3dBm to -75dBm measurement range

- PASS/FAIL testing with audible signal
- Manual or timer-driven data logging for periods from one second to one hour
- Data storage for 1,000 measurements
- RS232 interface for instrument configuration and data transfer to a PC-compatible workstation or serial printer
- Powered by a rechargeable nickel-metal hydride (NiMH) battery pack, four alkaline batteries or AC adapter
- Built-in NiMH battery charger with external power supply

Requires one Snap-On Connector (SOC) interface (See pages 29 and 30). Compatible with both PC and APC connectors.

Description	Cat (UPC) No.
Advanced Optical Power Meter, Medium Power to +3dBm	522B (60548)
Advanced Optical Power Meter, High Power to +27dBm	522B-HP (60549)



To accommodate other connector types, see our SOC/UCI adapters on pages 29 and 30 and reference cables on page 33.

InGaAs Optical Power Meter

Application:

Suitable for power measurements on both laser and LED based single-mode and multimode fiber optic systems.

Features:

- Easy-to-use; three buttons control all essential functions
- Multi-wavelength reference stores and recalls reference power levels for faster, more efficient measurement
- Rubber boot protects against dropping and crushing
- Rugged and splashproof

Specifications:

- 850nm, 1300nm, 1310nm and 1550nm calibration wavelengths
- InGaAs detector
- +3 to -60dBm measurement range
- 0.01dB measurement resolution
- Relative logarithmic dB and absolute logarithmic dBm units
- User-selectable auto shutoff
- Two AA batteries provide power for over 100 hours
- Optional AC power converter/adaptor is available for prolonged or benchtop use

Requires one Snap-On Connector (SOC) adapter (See pages 29 and 30). Compatible with both PC and APC connectors.



555B

Description	Cat (UPC) No.
InGaAs Optical Power Meter	555B (60567)
AC/Main Power Converter 120V (one required per handheld unit)	90ACK (60686)

Ge MT-RJ Optical Power Meter

Application:

Pair with an LED source to test insertion loss of multimode MT-RJ fiber optic cables and connectors or use independently to perform link loss testing of installed cable plants.

Features:

- Easy-to-use; three buttons control all essential functions
- Multi-wavelength reference storage capability permits convenient insertion and link loss testing at different transmission windows
- Wide area detector allows for testing of each channel individually, simultaneously or alternating between the two channels
- Rubber boot protects against dropping and crushing
- Rugged and splashproof

Specifications:

- 850nm, 1300nm and 1550nm NIST traceable calibration wavelengths
- Special extra-large area germanium detector
- +3 to -40dBm measurement range
- -0.01dB measurement resolution
- Relative logarithmic dB and absolute logarithmic dBm units
- User-selectable auto shutoff
- Two AA batteries provide power for over 100 hours
- Optional AC power converter/adaptor is available for prolonged or benchtop use

Requires one 13A2 for MT-RJ Snap-On Connector (SOC) adapter (See page 30). Compatible with both PC and APC connectors.



556MT

Description	Cat (UPC) No.
Ge MT-RJ Optical Power Meter	556MT (60552)
AC/Main Power Converter 120V (one required per handheld unit)	90ACK (60686)

### Silicon Optical Power Meter



557B

**Application:**

Optimized for power measurements on fiber optic systems based on single-mode, multimode, plastic or large core glass optical fibers and using near-infrared or visible light sources.

**Features:**

- Easy-to-use; three buttons control all essential functions
- Multi-wavelength reference stores and recalls reference power levels for faster, more efficient measurement
- Rubber boot protects against dropping and crushing
- Rugged and splashproof

**Specifications:**

- 635nm, 780nm and 850nm calibration wavelengths
- 3 x 3.5 mm Silicon detector
- +3 to -60dBm measurement range
- 0.01dB measurement resolution
- Relative logarithmic dB and absolute logarithmic dBm units
- User-selectable auto shutoff
- Two AA batteries provide power for over 100 hours
- Optional AC power converter/adaptor is available for prolonged or benchtop use

Requires one Snap-On Connector (SOC) adapter (See pages 29 and 30). Compatible with both PC and APC connectors.



To accommodate other connector types, see our SOC/UCI adapters on pages 29 and 30 and reference cables on page 33.

Description	Cat (UPC) No.
-------------	---------------

Silicon Optical Power Meter	557B (60553)
AC/Main Power Converter 120V (one required per handheld unit)	90ACK (60686)

### High Intensity InGaAs Optical Power Meter



558B

**Application:**

Suitable for power measurements on high power single-mode and DWDM fiber optic systems.

**Features:**

- Easy-to-use; three buttons control all essential functions
- Multi-wavelength reference stores and recalls reference power levels for faster, more efficient measurement
- Rubber boot protects against dropping and crushing
- Rugged and splashproof

**Specifications:**

- 980nm, 1310nm and 1550nm calibration wavelengths
- +25 to -30dBm measurement range at 1310/1550nm
- 0.01dB measurement resolution
- Relative logarithmic dB and absolute logarithmic dBm units
- User-selectable auto shutoff
- Two AA batteries provide power for over 100 hours
- Optional AC power converter/adaptor is available for prolonged or benchtop use

Requires one Snap-On Connector (SOC) interface (See pages 29 and 30). Compatible with both PC and APC connectors.

Description	Cat (UPC) No.
-------------	---------------

High Intensity InGaAs Optical Power Meter	558B (60568)
AC/Main Power Converter 120V (one required per handheld unit)	90ACK (60686)

### Fault Locators and Light Detectors

MODEL	T160L	T164L	T165L	263LX	263MT	MicroOTDR™	510 LS SensoLITE®
TYPE	Visible Laser	Visible Laser	Visible Laser	Visible Laser	Visible Laser	OTDR	Light Detector (Ge)
WAVELENGTH (nm)	635nm (RED)	635nm (RED)	635nm (RED)	635nm (RED)	635nm (RED)	1310nm	630 to 1600nm
DISTANCE	Up to 3 km (VERY BRIGHT)	Up to 1 km (BRIGHT)	Up to 1 km (BRIGHT)	Up to 3 km (VERY BRIGHT)	Up to 1 km (BRIGHT)	up to 20 km	
LIFE / BATTERY TYPE	48 hours (2 AA)	40 hours (2 AAA)	40 hours (2 AAA)	40 hours (2 AA)	24 hours (2 AA)	13,000 Tests (4 AA)	1 year (2 AA)
OPTICAL INTERFACE TYPE	2.5 mm Universal Interface	1.25 mm Universal Interface for Small Form Connectors (LC,MU)	2.5 mm Universal Interface	Fixed FC-PC Interface	Fixed MT-RJ Interface	Fixed ST-PC Interface	Universal Interface
Single-mode	●	●	●	●		●	
Multimode	●	●	●	●	●	●	●



T160L



T164L



T165L



263LX



263MT



55446



510LS

### Visual Fault Finder

**Application:**

Pinpoints cable breaks and bad connections in both single-mode and multimode fiber.

**Features:**

- Quick connect interface adapts to all standard PC and APC polished 2.5 mm ferruled connectors without adapters
- Both continuous and pulsed operation aid in fault detection even in high ambient lighted areas
- Pocket-sized
- Rugged, waterproof design

**Specifications:**

- Ultra-bright 635nm visible laser detects fiber breaks up to 3 km away
- Operates for over 48 hours on two AA batteries
- Includes integral dust cap and nylon, belt-mounted carrying pouch
- Optional snap-on adapters permit attachment to ST, SC and FC connectors



T160L

Description	Cat (UPC) No.
-------------	---------------

Visual Fault Finder	T160L (60562)
ST SOC Adapter	1630 (60580)
SC SOC Adapter	1662 (60581)
FC SOC Adapter	1620 (60582)

## Visual Fault Finders for 2.5 mm and 1.25 mm Connectors



T165L

### Application:

Enables the user to locate damage in ceramic connectors by causing the ferrule to glow when broken or when the endface is dirty or needs repolishing.

### Features:

- Low cost
- Quick-connect interface is easy to use and saves time and money
- Fiber breaks, bends and crimping losses are easy to locate with the 635nm red laser
- Fixed blink mode for easy fault location or identification
- Pocket-sized
- Rugged, compact, with rubberized and waterproof aluminum housing

### Specifications:

- 635nm red laser
- 0.5 mW minimum peak power into 9/125µm SM
- 0.07 mW minimum peak power into 50/125 µm 1 mm
- Blink frequency is 2 to 3Hz
- CORH Laser Class II
- Two AAA batteries provide power for over 40 hours

Compatible with both PC and APC polished connectors.

Description	Cat (UPC) No.
Visual Fault Finder for 1.25 mm Connectors	T164L (60622)
Visual Fault Finder for 2.5 mm Connectors	T165L (60621)

## FC-PC and MT-RJ Visual Fault Finders



263MT

### Application:

Used to quickly locate bending loss and breaks in optical fibers, and to identify bad connectors.

### Features:

- 635nm red laser makes fiber breaks and bending losses easily visible
- Stable, calibrated output
- Continuous wave output mode for steady fault illumination
- Blinking output mode increases viewing contrast
- Optional AC power converter/adaptor is available for prolonged or benchtop use

- Proven, reliable and compact design
- Economically priced
- Rugged and splashproof
- 263LX model includes fixed FC-PC interface, for use with optional FoPro® Adapter Cable (See page 32) or user-supplied hybrid cable (See page 33)
- 263MT model is designed for MT-RJ duplex connectors to test both fibers simultaneously

### Specifications:

- LX model has a range up to 3 km
- MT model has a range up to 1 km
- More than 40 hours of continuous operation

Description	Cat (UPC) No.
Visual Fault Finder	263LX (60538)
MT-RJ Visual Fault Finder	263MT (60539)
AC/Main Power Converter 120V (one required per handheld unit)	90ACK (60686)



55446

## MicroOTDR™ Optical Fault Locator

### Application:

Provides fast, easy and accurate identification of loss points/faults and length for multimode and single-mode fiber optic cable.

### Features:

- Easy-to-use; one button controls all essential functions
- Fast; takes less than six seconds to identify the distance to six optical events plus the cable end
- Delivers over 13,000 tests from four AA batteries
- Fixed ST-PC interface, use hybrid cables for other connector types

### Specifications:

- Uses 1310nm laser OTDR technology
- Measures cable length to 20 km
- Identifies distance to seven loss points/faults
- Distance accuracy of ±2 m
- ST-style output connection

Description	Cat (UPC) No.
MicroOTDR Optical Fault Locator	55446

## SensoLITE® Light Detector

### Application:

Identifies live multimode and single-mode fibers.

### Features:

- Helps prevent accidental eye exposure to hazardous laser radiation
- Simple one-button test
- Patented light baffle accepts all standard fiber optic connector types, bare fiber and even fiber loop
- Includes both audible and visible indicators
- Unique design permits testing in bright light conditions

### Specifications:

- Wide sensitivity from +25dBm to -55dBm
- Detects visible and invisible light wavelengths from 630nm to 1600nm
- Operates for approximately one year on two AA batteries
- Automatic battery check



510LS

Description	Cat (UPC) No.
SensoLITE Light Detector	510LS (60566)

## Bare Fiber Adapter

### Application:

Allows temporary connection of 125 micron multimode or single-mode fiber to measuring equipment such as Sources, Optical Power Meters and Fault Locators with an FC-style connector. Connection to other common fiber optic connector styles can be accomplished with a hybrid test jumper.

### Features:

- Short 5 mm minimum strip length provides easy insertion into the capillary and avoids fiber breakage
- Reusable

### Specifications:

- Includes a durable 2.5 mm tungsten carbide ferrule and a ferrule cleaning tool



55456

Description	Cat (UPC) No.
Bare Fiber Adapter (125µm, FC-style connector)	934-125 (55456)



LED Sources

MODEL	252B	253B	255MT	257MT
SOURCE TYPE	LED	LED	LED	LED
WAVELENGTHS (nm)	850/1300	650	1300	850
OPTICAL INTERFACE TYPE	SOC Universal	SOC Universal	Fixed MT-RJ	Fixed MT-RJ
Continuous and Modulated Output Modes	●	●	●	●
User-selectable Auto Shutoff	●	●	●	●
Single-mode	●		●	
Multimode (glass)	●		●	●
Multimode (plastic)		●		



252B



253B



255MT



257MT

Dual Wavelength LED Source

Application:

Perform multimode insertion loss and link loss measurements on local area networks, premises networks and Fiber Distributed Data Interface (FDDI) installations.

Features:

- Stable, calibrated output
- Proven, reliable and compact design
- Easy-to-use; three buttons control all essential functions
- Rubber boot protects against dropping and crushing
- Rugged and splashproof

Specifications:

- Single unit combines 850nm and 1300nm calibrated wavelengths
- Nominal output for 62.5/125 is -13dBm for 850nm and -20dBm for 1300nm
- Continuous and modulated output modes
- User-selectable auto shutoff
- TIA-568B compliant
- Two AA batteries provide power for over 24 hours
- Optional AC power converter/adaptor is available for prolonged or benchtop use

Requires two Snap-On Connector (SOC) adapters (See pages 29 and 30).



252B

Description	Cat (UPC) No.
Dual 850/1300nm LED Source	252B (60530)
AC/Main Power Converter 120V (one required per handheld unit)	90ACK (60686)

Single Wavelength 650nm LED Source

Application:

Performs multimode insertion loss and link loss measurements when paired with an optical power meter for POF testing.

Features:

- Stable, calibrated output
- Proven, reliable and compact design
- Easy-to-use; two buttons control all essential functions
- Rubber boot protects against dropping and crushing
- Rugged and splashproof

Specifications:

- Nominal output into 200/230 is -15dBm
- Continuous and modulated output modes
- User-selectable auto shutoff
- Two AA batteries provide power for over 24 hours
- Optional AC power converter/adaptor is available for prolonged or benchtop use

Requires one Snap-On Connector (SOC) adapter (See pages 29 and 30).



253B



To accommodate other connector types, see our SOC/UCI adapters on pages 29 and 30 and reference cables on page 33.

Description	Cat (UPC) No.
650nm LED Source	253B (60531)
AC/Main Power Converter 120V (one required per handheld unit)	90ACK (60686)

MT-RJ Dual Channel LED Sources

Application:

Test insertion loss of multimode MT-RJ fiber optic cables and connectors, or pair with an optical power meter for link loss testing of installed cable plants.

Features:

- Stable, calibrated output
- Proven, reliable and compact design
- Easy-to-use; two buttons control all essential functions
- Rubber boot protects against dropping and crushing
- Rugged and splashproof

Specifications:

- 255MT model has a 1300nm wavelength
- 257MT model has an 850nm wavelength
- Nominal output for 62.5/125 is -20dBm for both 850nm and 1300nm
- Continuous and alternating output modes
- Fixed MT-RJ interface
- User-selectable auto shutoff
- Two AA batteries provide power for over 24 hours
- Optional AC power converter/adaptor is available for prolonged or benchtop use



255MT

Description	Cat (UPC) No.
MT-RJ Dual Channel LED Source 1300nm	255MT (60533)
MT-RJ Dual Channel LED Source 850nm	257MT (60536)
AC/Main Power Converter 120V (one required per handheld unit)	90ACK (60686)

Laser Sources

MODEL	262A	265A	266A
SOURCE TYPE	Fabry-Perot Laser	Fabry-Perot Laser	Fabry-Perot Laser
WAVELENGTHS (nm)	1310/1550	1310	1550
OPTICAL INTERFACE TYPE	UCI Universal	UCI Universal	UCI Universal
Continuous and Modulated Output Modes	●	●	●
User-selectable Auto Shutoff	●	●	●
Single-mode	●	●	●
Multimode (glass)			



262A



265A



266A

1310/1550 Dual Wavelength Laser Source



262A

Application:

Performs single-mode insertion loss and link loss measurements when paired with an optical power meter.

Features:

- Single output interface simplifies dual wavelength measurements
- Stable, calibrated output
- Proven, reliable and compact design

- Easy-to-use; three buttons control all essential functions
- Rubber boot protects against dropping and crushing
- Rugged and splashproof

Specifications:

- Single unit toggles between 1310nm and 1550nm wavelengths
- Fabry-Perot laser diodes
- Calibrated output power is nominal -7.0dBm
- Continuous and modulated output modes
- User-selectable auto shutoff
- Two AA batteries provide power for over 50 hours
- Optional AC power converter/adaptor is available for prolonged or benchtop use

Requires one UCI adapter (See pages 29 and 30). For PC polished connectors only. For APC connectors, use hybrid reference cables (See page 33).



To accommodate other connector types, see our SOC/UCI adapters on pages 29 and 30 and reference cables on page 33.

Description	Cat (UPC) No.
Dual Laser Source	262A (60564)
AC/Main Power Converter 120V (one required per handheld unit)	90ACK (60686)

Single Wavelength Laser Sources

Application:

Performs single-mode insertion loss and link loss measurements when paired with an optical power meter.

Features:

- Stable, calibrated output
- Proven, reliable and compact design
- Easy-to-use; two buttons control all essential functions
- Rubber boot protects against dropping and crushing
- Rugged and splashproof

Specifications:

- 265A has a 1310nm wavelength and -7dBm output for single-mode testing
- 266A has a 1550nm wavelength and -7dBm output for single-mode testing
- Continuous and modulated output modes
- User-selectable auto shutoff
- The 265A model operates for over 36 hours on two AA batteries
- The 266A model operates for over 80 hours on two AA batteries
- AC power converter/adaptor is available for prolonged or benchtop use

Requires one UCI adapter (See pages 29 and 30). For PC polished connectors only. For APC connectors, use hybrid reference cables (See page 33).



265A



To accommodate other connector types, see our SOC/UCI adapters on pages 29 and 30 and reference cables on page 33.

Description	Cat (UPC) No.
1310nm Laser Source, SM	265A (60565)
1550nm Laser Source, SM	266A (60544)
AC/Main Power Converter 120V (one required per handheld unit)	90ACK (60686)

fiberTOOLS® Carrying Cases

Application:

Designed to hold Tempo handheld instruments and a full range of test accessories.

Features:

- **900B and 901B Hard Carrying Cases**
- Top tray holds up to 3 (900B) or 4 (901B) handheld instruments and a T160L Visual Fault Finder
- Bottom compartment of both models stores additional instruments and test accessories
- Compact, waterproof and lockable
- Molded from black structural foam resin

911B and 912B Soft Carrying Cases

- Main top-loading compartment holds up to 2 (911B) or 3 (912B) handheld instruments
- Front storage compartment of both models provides storage for adapters, cables and other accessories
- All compartments secured by heavy-duty YKK zippers
- Soft, padded, rugged canvas-style nylon case
- Includes shoulder strap and belt loops (on back)



900B

Instruments and accessories not included



911B

Instruments and accessories not included

Description	Cat (UPC) No.
Hard Carrying Case, Holds 3x Handhelds	900B (60684)
Hard Carrying Case, Holds 4x Handhelds	901B (60685)
Soft Carrying Case, Holds 2x Handhelds	911B (60579)
Soft Carrying Case, Holds 3x Handhelds	912B (60688)

## Fiber Optic Instrument Adapters — SOC and UCI

### Application:

Our SOC and UCI adapters provide direct connectivity for Tempo fiberTOOLS® to a wide range of industry-standard fiber optic connectors.

### Features:

- Adapter design ensures maximum accuracy and repeatability when performing critical measurements on fiber optic systems
- Easy to clean and use

### Specifications:

- Single-mode and multimode compatible
- SOC adapters are compatible with both PC and Angled APC physical contact interfaces
- UCI adapters feature durable phosphor bronze alignment sleeve
- SOC (Snap-On Connector) adapter is used on all power meters and 250 "B" series LED Sources
- UCI (Universal Connector Interface) adapter is used on all 250/260 "A" Series Sources and 330 Series Variable Optical Attenuators

## Fiber Optic Instrument Adapters — SOC and UCI

Description	Cat (UPC) No.	
CONNECTOR TYPE	SOC ADAPTER	UCI ADAPTER
1.25 mm Quick-Connect Universal Adapter (LC, MU, etc.)	 T1026 (60588)	Use hybrid cable only *
2.5 mm SOC Quick-Connect Adapter (E2000, FC, SC, ST, etc.)	 T1025 (60587)	 AU-250 (60703)
Blank Adapter (for custom applications)	 T1001 (60585)	
D4	 T1089 (60597)	Use hybrid cable only *
DIN 47256	 T1010 (60586)	 AD-108 (60697)
E-2000	 T10E2 (60599)	 AE2-10 (60698)
EC-Radiall	 T10E0 (60598)	Use hybrid cable only *
FC	 T1020 (60576)	 APC-108 (60572)
HMS-0	 1050 (60592)	 AMS-00 (60700)
HMS-10/A (SMA-2.5 mm)	 1086 (60595)	 AMT-10 (60701)
HMS-10/HP	 1040 (60590)	 AHP-10 (60699)
LC	 10LC (60600)	Use hybrid cable * or FoPro® x

## Fiber Optic Instrument Adapters — SOC and UCI

Description	Cat (UPC) No.	
CONNECTOR TYPE	SOC ADAPTER	UPI-PC ADAPTER
MIL-T-29504/4 & /5 Termini	 T1038 (60589)	Use hybrid cable * or FoPro x
Mini-BNC	 T1047 (60591)	Use hybrid cable only *
MT-RJ ♦	 T13A2 (60605) ♦	Use hybrid cable only *
MT-RJ Ferrule Only ♦	 T13AF (60606) ♦	Use hybrid cable only *
MU	 T10MU (60601)	Use hybrid cable * or FoPro x
SC	 T1062 (60575)	 ASC-108 (60574)
SMA 905/906	 T1087 (60596)	 ASM-90 (60702)
ST	 T1030 (60577)	 ATS-108 (60573)
STRATOS 430/ HOLTEK 38000	 T1057 (60593)	Use hybrid cable only *
TOSLINK — Simplex	 T10TB (60602)	Use hybrid cable only *
TOSLINK — Duplex (Set of 2)	 T10TD (60603)	Use hybrid cable only *
Versatile Link — V/Z PIN	 T10ZP (60604)	Use hybrid cable only *
VFO — Radiall	 T1081 (60594)	Use hybrid cable only *

x FoPro ferrule options include 2.5 mm, 1.57 mm (Mil-style 16AWG optical contacts) and 1.25 mm.

\* When using a Hybrid Adapter Cable, the instrument UCI adapter and one end of the Hybrid Adapter Cable should be a commonly available connector type. (i.e. FC, SC or ST)

♦ SOC adapter for use only with the 556MT Optical Power Meter on page 20.



### 90SOC (60687)

SOC adapter tool for easy installation and removal of SOC adapters from instrument interfaces.

## fiberSAFE™ USA/Canada Telecom Adapter Kit — SOC and UCI



### Application:

Conveniently combines the most popular SOC, UCI and bulkhead mating adapters used in the North American telecommunications market. Enables direct connectivity for Tempo fiberTOOLS® to industry-standard fiber optic connectors.

### Specifications:

#### USA/Canada Telecom Adapter Kit includes:

- FC-PC/APC (wide key) bulkhead/mating adapter
- ST-PC/APC bulkhead/mating adapter

- SC-PC/APC bulkhead/mating adapter
- E2000-PC/APC bulkhead/mating adapter
- FC/SC hybrid bulkhead adapter
- FC/ST hybrid bulkhead adapter
- FC/E2000 hybrid bulkhead adapter
- Universal 2.5 mm Quick Connect SOC adapter

Description	Cat (UPC) No.
USA/Canada Adapter Kit	956US (60695)

## fiberSAFE Worldwide Telecom Adapter Kit — SOC and UCI

### Application:

Conveniently combines the most popular SOC, UCI and bulkhead mating adapters used outside the USA and Canada. Enables direct connectivity for Tempo fiberTOOLS to industry-standard fiber optic connectors.

### Specifications:

#### Worldwide Telecom Adapter Kit includes:

- DIN 47256-PC/APC bulkhead/mating adapter
- FC-PC/APC (wide key) bulkhead/mating adapter
- SC-PC/APC bulkhead/mating adapter
- E2000-PC/APC bulkhead/mating adapter

- FC/DIN hybrid bulkhead adapter
- FC/SC hybrid bulkhead adapter
- FC/E2000 hybrid bulkhead adapter
- Universal 2.5 mm Quick Connect SOC adapter

Description	Cat (UPC) No.
Worldwide Adapter Kit	956WW (60696)

## fiberSAFE LAN Adapter Kit — SOC and UCI

### Application:

Conveniently combines the most popular SOC, UCI and bulkhead mating adapters used for Local Area Networks. Enables direct connectivity for Tempo fiberTOOLS to industry-standard fiber optic connectors.

### Specifications:

#### LAN Adapter Kit includes:

- FC-PC/APC (wide key) bulkhead/mating adapter
- ST-PC/APC bulkhead/mating adapter
- SC-PC/APC bulkhead/mating adapter

- SMA 905/906 bulkhead/mating adapter
- FC/ST hybrid bulkhead adapter
- ST/SC hybrid bulkhead adapter
- Universal 2.5 mm Quick Connect SOC Adapter

Description	Cat (UPC) No.
LAN Adapter Kit	956LN (60694)

## FoPro® Fiber Optic Test Probes

### Application:

By eliminating the need for specialized connectors, adapters and hybrid jumper cables, FoPro fiber optic probes simplify testing patch panels and the numerous termination types encountered in the field.

### Features:

- Small, light and cost effective
- Patented design protects delicate connector endfaces from scratching
- Anti-rotation grip prevents the probe endface from grinding against the connector endface during a test
- Eliminates the need to stock numerous hybrid test cable configurations

### Specifications:

- All standard FoPro assemblies are 3 m (9.8') long and come in a protective carrying case
- A tethered adapter converts the FoPro from a male to female interface for testing to plug connectors as well as testing the "pin" interface of multichannel connectors

#### Available in three ferrule configurations:

- FP series for connector applications with 2.5 mm OD ferrules (DIN, E2000, FC, SC, ST, etc.)
- F1 series for connector applications with 1.25 mm OD ferrules (LC, MU, etc.)
- F2 series for MIL-T-29504 /4 and /5 terminations applications with 1.57 mm (0.62") OD ferrules



Description	Cat (UPC) No.	Cat (UPC) No.	Cat (UPC) No.	Cat (UPC) No.
<b>FoPro with 2.5 mm Ferrule:</b>	<b>SM 9/125</b>	<b>MM 50/125</b>	<b>MM 62.5/125</b>	<b>MM 100/140</b>
FC-PC	FP2K-101-03 (60704)	FP2K-105-03 (60705)	FP2K-106-03 (60706)	
ST-PC	FP3K-101-03 (60707)	FP3K-105-03 (60708)	FP3K-106-03 (60709)	FP36-110-03 (60728)
SC-PC	FP6K-101-03 (60710)	FP6K-105-03 (60711)	FP6K-106-03 (60712)	
<b>FoPro with 1.25 mm Ferrule:</b>	<b>SM 9/125</b>	<b>MM 50/125</b>	<b>MM 62.5/125</b>	<b>MM 100/140</b>
FC-PC	F12K-101-03 (60713)	F12K-105-03 (60714)	F12K-106-03 (60715)	
ST-PC	F13K-101-03 (60716)	F13K-105-03 (60717)	F13K-106-03 (60718)	F136-110-03 (60729)
SC-PC	F16K-101-03 (60719)	F16K-105-03 (60720)	F16K-106-03 (60721)	
<b>FoPro with MIL-style 1.57 mm Ferrule:</b>	<b>SM 9/125</b>	<b>MM 50/125</b>	<b>MM 62.5/125</b>	<b>MM 100/140</b>
ST-PC	F23K-101-03 (60722)	F23K-105-03 (60723)	F23K-106-03 (60724)	F236-110-03 (60730)

## TIA-568B and FOTP-171A Certified Reference Cables

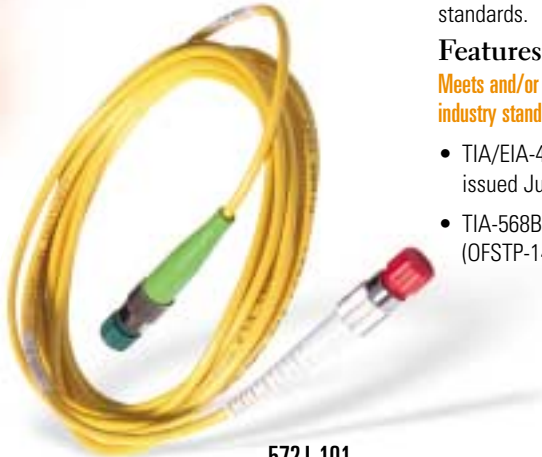

572J-101

### Application:

Ensures accurate measurements for repeatable and reproducible testing to the latest industry standards.

### Features:

Meets and/or exceeds the latest industry standards including:

- TIA/EIA-455-171 (FOTP-171A), issued June, 2001
- TIA-568B, TIA-562-7 (OFSTP-7) and TIA-526-14 (OFSTP-14) for optical link testing

- TIA-455-171 (FOTP-171, Attenuation) and TIA-455-8 (FOTP-8, Return Loss) for cable assembly testing
- Corresponding IEC measurement standards

### Specifications:

- Ferrule OD: 2.4990 ±0.0005 mm
- Fiber to ferrule eccentricity: ≤ 0.25µm (SM) and ≤ 3µm (MM)
- Insertion loss: ≤ 0.15dB (SM, 1310/1550nm) and ≤ 0.25dB (MM, 850/1300nm)
- Return Loss: ≥ 55dB (SM, 1310/1550nm) and ≥ 40dB (MM, 850/1300nm)
- Beam exit angle: ≤ 0.25° (SM) and ≤ 0.5° (MM)
- Standard length is 3 m

### Standard Reference Cables (Type A to Type B)

Description	Cat (UPC) No.	Description	Cat (UPC) No.	Cat (UPC) No.
<b>Single-mode Reference Cables:</b>		<b>Multimode Reference Cables:</b>		
			50/125	62.5/125
FC-PC to FC-PC	562K-101 (60658)	FC-PC to FC-PC	562K-105 (60659)	562K-106 (60660)
ST-PC to ST-PC	563K-101 (60661)	ST-PC to ST-PC	563K-105 (60662)	563K-106 (60663)
SC-PC to SC-PC	566K-101 (60664)	SC-PC to SC-PC	566K-105 (60665)	566K-106 (60666)
E2000-PC to E2000-PC	56E2-101 (60667)	E2000-PC to E2000-PC	56E2-105 (60668)	56E2-106 (60669)
LC-PC to LC-PC	56LC-LFM (60670)	LC-PC to LC-PC	56LC-LM5 (60671)	56LC-LM6 (60672)
MU-PC to MU-PC	56MU-LFM (60673)	MU-PC to MU-PC	56MU-LM5 (60674)	56MU-LM6 (60675)

### Hybrid Reference Cables (FC-PC to Type-A)

Description	Cat (UPC) No.	Description	Cat (UPC) No.	Cat (UPC) No.
<b>Single-mode Reference Cables:</b>		<b>Multimode Reference Cables:</b>		
			50/125	62.5/125
FC-PC to FC-APC	572J-101 (60680)			
FC-PC to SC-APC	576J-101 (60681)			
FC-PC to E2000-APC	57E8-101 (60682)			
FC-PC to LC-PC	57LC-LFM (60733)	FC-PC to LC-PC	57LC-LM5 (60734)	57LC-LM6 (60735)
FC-PC to MU-PC	57MU-LFM (60736)	FC-PC to MU-PC	57MU-LM5 (60737)	57MU-LM6 (60738)



262A

### Dual Wavelength Laser Source

To measure attenuation of SM links with APC polished connectors, use our 262A Dual Wavelength Laser Source (see page 27) with the APC-108 FC UCI Adapter (see page 29) and a Hybrid Reference Cable. Use same hybrid reference cable approach for LC-PC and MO-PC connectors.

For special reference cable requirements, contact us by phone at 1.805.389.9800 or by email at [fiberoptics@tempo.textron.com](mailto:fiberoptics@tempo.textron.com).



# Tones and Probes



### Classic 77 Series Tone Generators



77HP

**Application:**  
Permits technicians to identify the conductor within a bundle, at a cross-connect point or at the remote end. Can be used on twisted pair wiring (telecom, datacom, etc.), single conductors, coaxial cables, de-energized AC wiring and most other wiring.

Description	Cat (UPC) No.
77HP Tone Generator	77HP (08687)
77HP/6A Tone Generator	77HP/6A (08688)
77HP/6AC Tone Generator	77HP/6AC (60480)



77CS (08686)  
Leather Belt Holster for Classic 77 Series Tone Generators

### Classic 77 Series Tone Generators

FEATURES / SPECIFICATIONS	77HP	77HP / 6A	77HP / 6AC
Selectable Warble Tone	●	●	●
Continuity Testing	●	●	●
Polarity Testing	●	●	●
Talk Battery Supply	●	●	●
Two-line Modular Test Lead (RJ-11)	●	●	●
Three-color LED (identifies AC ring voltage)	●	●	●
Weather-resistant Design	●	●	●
Bent Nose Clips with Bed-of-Nails Penetrator		●	●
Cloth Test Leads			●
Battery Operated (9V not included)	●	●	●

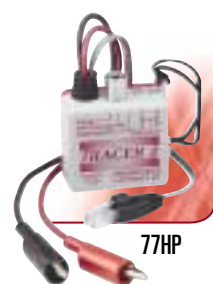

77HP



77HP/6A



77HP/6AC

### Professional GX Series Tone Generators



77GX

New

- Features:**
- Microprocessor controlled circuitry for increased reliability
  - Two-line polarity indication for fast outlet identification
  - Automatic shutoff to prevent battery drain
  - Snag-proof boot prevents broken plug tabs
  - Convenient wrist/hanging lanyard

- Specifications:**
- Three distinct, selectable tone signal outputs for multiple line identification
  - Two selectable tone power outputs for use on open and shorted pairs
  - Independent continuity test function
  - Independent talk battery supply with higher output voltage
  - Fixed alligator clips and removable modular plug for multiple connection options
  - 77GX2 includes premium telco-style bent nose clips with piercing pin and bed-of-nails connectors

Description	Cat (UPC) No.
77GX Tone Generator	77GX (60556)
77GX2 Tone Generator	77GX2 (60560)

### Replacement Piercing Clips



RPC

**Application:**  
These traditional telco-style clips can be used with almost any style cordsets.

- Specifications:**
- Clips feature bent nose design for use on 66 style punchdown blocks and bed-of-nails penetrator for use on insulated wires
  - Package of two clips with red and black boots

Description	Cat (UPC) No.
Replacement Piercing Clips	RPC (08710)

### AdapToner Modular Breakout Tone Generator



AT8

**Application:**

The AT Tone Generator makes it simple to test continuity, polarity, send tone and even supply talk battery to any configuration of pairs in 8-position modular jacks and plugs.

**Features:**

- Combines the features of our tone generators and a modular breakout adapter
- In-line testing is made simple with both a modular plug and jack on each unit

**Specifications:**

- 8-position "snag-proof" modular plug
- 8-position jack with protective cover
- Quick reference guide with common wiring configurations
- Selectable solid/warble tone signal
- Tone, continuity and talk battery supply using alligator clips
- Weather-resistant design
- Battery operated (9V not included)

Description	Cat (UPC) No.
AdapToner Modular Breakout Tone Generator	AT8 (08693)

### LAN Toner With HUB Blink



AT8L

**Application:**

The LAN Toner is designed for the network installation and maintenance professional and can be used on any wiring system including datacom, telecom, security/alarm, audio and CATV.

**Features:**

- Blinks HUB, Switch Port, and PC activity lights for fast identification
- Provides tone signaling, continuity testing and telephone line polarity indication combined with a modular breakout adapter
- Selectable tone outputs for identifying multiple cable runs
- Includes multiple connection options

Description	Cat (UPC) No.
LAN Toner	AT8L (60583)



600LS

### Tone Test Set

**Features:**

- Our most comprehensive tone test set
- Traditional alternating tone signal for wire identification
- Audible line condition testing (level) indicates dead, working and off-hook lines

**Specifications:**

- Line 1 and 2 polarity testing using 4-conductor modular plug
- Improved talk battery supply for communication over inactive pairs
- Tone and test functions using either modular plug or 24" alligator clip leads
- Audible resistance level measurement
- Audible capacitance level measurement
- Battery operated (9V not included)

Description	Cat (UPC) No.
Tone Test Set	600LS (08680)



600CS (08679)  
Leather Belt Holster for 600LS Test Set

### Alarm Loop Verifier/Tone Generator

**Application:**

Designed specifically for the security and alarm industry, the PE620 can be connected to a Normally Open or Normally Closed loop pair and provides a distinct audible tone when the alarm condition occurs.

**Features:**

- Latching feature provides a simple method for identifying intermittent failures ("swingers") and confirming operation of switches at remote locations

- In the latching mode, the unit will catch the alarm condition and continue sounding until the tester is reset
- As a tone generator, the unit provides a traditional variable tone that can be applied using the 24" red and black test leads or a convenient 6-position modular plug
- Convenient magnetic back plate allows the PE620 to be mounted directly to the control panel cabinet or door

**Specifications:**

- Battery operated (9V not included)

Description	Cat (UPC) No.
Alarm Loop Verifier/Tone Generator	PE620 (08665)



100C (08668)  
Leather Belt Holster for PE620 Tone Generator



PE620



### 200 Series Inductive Amplifiers

MODEL NO.	200EP	200GX	200FP
Powerful 2" Speaker	●	●	
Powerful, Rear-fire Speaker			●
One-button Operation	●	●	●
Adjustable Volume Control	●	●	●
LED for Visual Signal Strength Indication	●	●	●
Recessed Tabs for Telephone Test or Headset Connection	●	●	●
Speaker Bypass When Using Telephone Test Sets		●	
Noise Filtration			●
Improved Tip Design for Better Reception and Lower Risk of Shorting Terminals		●	●
Continuous-on Feature			●
Five-minute Auto Shutoff			●
Low-battery Indicator			●
Battery Operated (9V not included)	●	●	●

**New**



200EP

200GX

200FP

### Inductive Amplifiers

**Application:**  
Used in conjunction with any tone generator, Inductive Amplifiers permit wire and cable identification without having to make direct metallic contact with the conductor.

**Features:**

- All models feature powerful speaker for noisy environments, recessed on/off button control and high gain for accurate wire identification in congested cable bundles and equipment rooms

- The 200EP also includes adjustable volume control for precise identification, an LED for visual signal strength indication and recessed telephone test set connectors
- The 200GX includes all the features of the 200EP in a new rugged, ergonomically-designed housing

Description	Cat (UPC) No.
Inductive Amplifier	200EP (08671)
Inductive Amplifier	200GX (60557)

200GX

200C (08670)

Leather Belt Holster for 200 Series Inductive Amplifiers



**200FP**  
U.S. Pat. No. 5,457,441; 5,574,769 and 5,577,099

### Filter Probe

**Application:**  
By selectively filtering out all 60Hz and 60Hz harmonics, the 200FP can be used with any tone generator for faster, more accurate, cable and wire identification.

**Features:**

- With three types of noise filtration, the Filter Probe virtually eliminates power-related noise from the tone-and-probe operation
- Slim, comfortable design for use in limited-space areas

- Recessed on/off push-button control to conserve battery life
- Adjustable sensitivity/volume control to increase accuracy
- Blended carbon/plastic tip to reduce the risk of shorting terminals

Description	Cat (UPC) No.
Filter Probe	200FP (08672)



RPT-1

RPT-2

### Replacement Plastic Tips for 200 Series Probes

**Application:**  
Plastic tips perform much the same as traditional metal tips while reducing the risk of shorting terminals.

- Specifications:**
- Specially formulated with a carbon powder and carbon fiber blended plastic
  - Tips fit 200B, 200EP, 200GX and 200FP probes
  - RPT-1 comes with two pencil-style tips and two spade-style tips

Description	Cat (UPC) No.
Replacement Plastic Tips for 200B, 200EP, 200FP	RPT-1 (08711)
Replacement Plastic Tips for 200GX	RPT-2 (60561)

### Replacement Metal Tips for 200B and 200EP Probes

**Application:**  
Metal tips provide maximum performance when probing insulated wires or making direct metallic contact.

- Specifications:**
- Made of nickel-plated brass
  - Tips fit 200B and 200EP probes
  - Package contains two pencil-style tips



RMT-1

Description	Cat (UPC) No.
Replacement Metal Tips for 200B and 200EP Probes	RMT-1 (08709)

### Classic Tone and Probe Kit



**Application:**

Used to identify single conductors or cables within a bundle, at a cross-connect point or at remote ends.

**Specifications:**

- Kit includes the 77HP High Power Tone Generator and the 200EP Inductive Amplifier in a rugged, woven polyester carrying case

701K

Description	Cat (UPC) No.
Classic Tone and Probe Kit	701K (08684)

### Professional Tone and Probe Kit



**Application:**

Designed for the telecom professional, this kit is for use on single conductors, twisted pairs, coax cables and de-energized electrical wiring.

**Features:**

- Housings are drop-tested to ensure durability

**Specifications:**

- Kit includes the 77GX Tone Generator and 200GX Inductive Amplifier in a rugged carrying case

711K

Description	Cat (UPC) No.
Professional Tone and Probe Kit	711K (60558)

### Premium Tone and Probe Kit



**Application:**

Designed for more accurate wire identification, the 801K virtually eliminates power-related noise from the tone and probe operation.

**Specifications:**

- Kit includes the 77HP/6A High Power Tone Generator and 200 FP Filter Probe in a convenient Cordura® case

801K

Description	Cat (UPC) No.
Premium Tone and Probe Kit	801K (08690)

### AdapToner Kit



**Application:**

Designed for fast, accurate wire identification by combining the features of our tone generators and modular breakout adapter.

**Specifications:**

- Kit includes the AT8 Modular Breakout Tone Generator and 200EP Inductive Amplifier in a convenient carrying case

AT8K

Description	Cat (UPC) No.
AdapToner Kit	AT8K (08694)

### LAN Toner Kit



AT8LK

**Application:**

Designed for the network installation and maintenance professional, the LAN Toner sends tone and blinks HUB, Switch Port, and PC activity lights for fast identification. This kit can be used on any wiring system including datacom, telecom, security/alarm, audio and CATV.

**Specifications:**

- Kit includes the AT8L LAN Toner and the 200GX Inductive Amplifier in a rugged, woven polyester carrying case

Description	Cat (UPC) No.
LAN Toner Kit	AT8LK (60584)

### CATV Cable Tone Test Kit



402K

**Application:**

Designed specifically for the CATV industry, this kit allows you to tone through splitters, directional couplers and traps.

**Feature:**

- Simple to use, the 402K provides accurate results and will eliminate long delays trying to figure out non-tagged or mis-tagged cable drops

**Specifications:**

- Kit includes one transmitter, one receiver, one male F-to-F connector adapter cable, one male F-to-alligator clip adapter cable and a carrying case
- Transmitter and receiver are equipped with female F-connectors
- Three methods of signal reception: electrostatic pickup for non-terminated cables, electromagnetic pickup for terminated or shorted cables and direct connection when identifying in the presence of passive devices
- In continuity mode, provides both audible tone and LED display
- Identifies the presence of AC or DC voltage on the cable under test
- Four selectable tone outputs for multiple line identification

Description	Cat (UPC) No.
CATV Cable Tone Test Set	402K (08677)

### Security and Alarm Kit



620K

**Application:**

Designed specifically for the security and alarm industry, the 620K provides a simple method for identifying intermittent failures (swingers) and confirming operation of switches at remote locations.

**Specifications:**

- To better satisfy industry requirements, we've combined the Model PE620 Tone Generator with the popular Model 200EP Inductive Amplifier in a durable woven polyester pouch

Description	Cat (UPC) No.
Security and Alarm Kit	620K (08682)



140

## A-Bug™ Tone Probe and Sender

### Application:

Used for pair identification, cable pair tracing and fault location in telephone, LAN and other metallic cables.

### Features:

- Superior gain and dynamic range to detect tones in the full spectrum of amplitudes
- Unwanted signals are filtered out while still allowing for superior tone detection
- Glass-reinforced nylon probe tip is extremely durable
- Ergonomic design fits easily in the hand and in tight splice bundles
- Multi-purpose tone sender also tests lines for voltage, polarity and continuity

### Specifications:

- Automatic-off feature
- Two Sender models are available: the 150 model features alligator clips and the 150P features popper-style clips
- Optional headphone is available for use in noisy locations

### Tone Probe Kits include:

- 140 Tone Probe
- 150 or 150P Tone Sender
- Lightweight headphones
- Holster
- Two batteries

Description	Cat (UPC) No.	Description	Cat (UPC) No.
A-Bug Tone Probe	140 (60760)	A-Bug Tone Probe Kit (Sender w/Alligator Clips)	240 (60780)
A-Bug Tone Probe – Filtered	140D (60781)	A-Bug Tone Probe Kit (Sender w/ Popper-style Clips)	240P (60759)
A-Bug Tone Sender w/ Alligator Clips	150 (60779)	Holster for A-Bug Tone Probe	360 (60762)
A-Bug Tone Sender w/ Popper-style Clips	150P (60761)	Holster for A-Bug Tone Sender	362 (60763)
A-Bug Tone Sender – Filtered	150D (60782)	A-Bug Headphones	361 (60778)

## Cabling Pouch



750C

### Application:

Designed to hold a complete set of wiring tools including: any (one) 77 Series Tone Generator, any (one) 200 Series Inductive Amplifier, a punchdown tool, a cabling knife and scissors.

### Features:

- Convenient loop to hold most telephone test sets
- Removable “parts pouch” allows you to keep small components in reach
- Made of a durable woven polyester
- Fits belts up to 5" wide

Description	Cat (UPC) No.
Cabling Pouch	750C (08685)

## Tone and Probe Carrying Case



700C

### Application:

Allows you to build your own kit using any tone generator and 200 Series probe.

### Features:

- Durable woven polyester case
- Fits belts up to 3" wide

Description	Cat (UPC) No.
Tone and Probe Carrying Case	700C (08683)



Cable Locators

### Tracker II

**Application:**

Traces the path and determines the depth of wires and metallic pipes on active or dead systems without having to deactivate the system.

**Features:**

- Lightweight receiver provides audible and visual indications of signal strength
- Transmitter output and receiver sensitivity are fully adjustable for maximum accuracy
- Transmitter offers three methods of connection: direct, inductive coupler and inductive antenna

**Specifications:**

- Includes transmitter assembly, receiver assembly, inductive coupler (clamp), built-in inductive antenna, two 8' test leads (2.4 m) with heavy-duty alligator clips and a durable polyethylene case
- High frequency transmitter provides range up to 4,000' (1,219 m) and depths up to 7' (2 m)
- Receiver is 32" long (813 mm)
- Battery operated (eight AA and one 9V battery is included)
- Molded carrying case included



501

Description	Cat (UPC) No.
Tracker II	501 (08662)



HS-1 (08695)

Optional headset is available for use in high-traffic areas or other noisy environments.

### Buried Line Locator

**Features:**

- LED and LCD signal strength indicators make it quick and easy to find exact line location
- Lightweight and ergonomically balanced
- Automatic signal boost makes it easy to trace lines, even those with very weak signals
- Receiver may be used in active or passive mode
- Receiver locates multiple passive frequencies with a single setting

- Receiver automatically locks out passive range when it detects a transmitter signal, reducing the chance of tracing other lines carrying weaker signals
- Microprocessor-based circuitry delivers increased accuracy and features auto-gain control in all environments

**Specifications:**

- Traces 20' (6 m) underground and provides depth readings up to 15'
- Transmitter can be connected to live lines up to 600V
- Molded carrying case included



BLL-200

Description	Cat (UPC) No.
Buried Line Locator	BLL-200 (07796)

### Pulser

**Application:**

Identifies the exact location of even the smallest breaks in insulation by "pulsing" a high-voltage signal that radiates into the earth at the location of the faults. With the A-frame mounted receiver, a visual analog meter points the way to the source of the voltage.

**Features:**

- Multiple faults on a single wire can be identified indicating the need to replace instead of repair
  - Extra-long test leads feature heavy-duty alligator clips for use on multiple cable types
- Specifications:**
- Includes a rechargeable transmitter, receiver, A-frame, ground stake, 120V charger and a 12V DC (cigarette lighter) adapter
  - Battery operated (one 12V and one 9V battery is included)
  - Molded carrying case included



PE2003

Great complement to any buried cable locator.

Description	Cat (UPC) No.
Pulser	PE2003 (08666)

### Wire Finder/Mini Locator

**Application:**

Used to trace energized or degenerated wires in walls and drop ceilings.

**Features:**

- Determines the approximate depth of a wire before digging begins
- Transmitter and receiver are fully-adjustable for accurate locating
- Reliable results on buried cables to depths of 3' and lengths up to 1000'
- Quick-change test leads for use in any industry, even international power outlets
- Voltage protection allows use on live AC circuits

- Automatic shutoff prevents accidental battery discharge
- Both the transmitter and receiver are housed in a durable, molded carrying case with a quick reference operation guide on the inside of the lid
- Compact design
- Easy-to-understand operations

**Specifications:**

- Battery operated (two 9V batteries included)
- Molded carrying case included



508S

Description	Cat (UPC) No.
Wire Finder/Mini Locator	508S (08678)

## Uni Marker™



### Application:

Electronically marks buried facilities for later relocation.

### Features:

- Rugged polyethylene case ensures years of useful life
- Small size and flat design attach easily to non-metallic utility box lids, hand holes and other buried enclosures

- Location is simple with any modern marker locator
- Range is 25% more than other similar-style markers
- Signal peak ensures location within inches of the marker

### Specifications:

- Color coded by utility application

Application	Color	Frequency	Cat (UPC) No.
Power	Red	169.8kHz	170 (60771)
Water	Blue	145.7kHz	171 (60772)
Sanitary	Green	121.6kHz	172 (60773)
Telephone	Orange	101.4kHz	173 (60774)
Gas	Yellow	83.0kHz	174 (60775)
Cable TV	Orange/Black	77.0kHz	175 (60776)

## Omni Marker™



### Application:

Electronically marks and relocates buried facilities.

### Features:

- Unique design produces a uniform, spherical RF field in every direction
- Easily located up to 5' away with any modern marker locator

- Wider field with a signal peak directly above the marker provides precise location
- Requires no particular orientation when buried
- Greater range than standard 4" ball markers
- High-reliability design lasts as long as your buried plant

### Specifications:

- Color coded by utility application

Application	Color	Frequency	Cat (UPC) No.
Power	Red	169.8kHz	160 (60765)
Water	Blue	145.7kHz	161 (60766)
Sanitary	Green	121.6kHz	162 (60767)
Telephone	Orange	101.4kHz	163 (60768)
Gas	Yellow	83.0kHz	164 (60769)
Cable TV	Orange/Black	77.0kHz	165 (60770)



Kits



### Clip-On Twisted Pair Kit



46010

**Application:**

Provides the most essential tools for terminating voice and data cabling right at the installer's side.

**Features:**

- Rugged Cordura® pouch is built to last, lowering replacement costs
- Heavy-duty metal clip snaps over the installer's belt so that the kit can be removed without removing the belt
- Side holsters allow the installer to carry a flashlight and a favorite screwdriver

Description	Cat (UPC) No.
Clip-On Twisted Pair Kit	46010
<i>Kit contents may be purchased separately:</i>	
Punchdown Tool with 110 Blade	46023
Electrician's Scissors	PT-T02 (08708)
Twisted Pair Stripper	45579
Pocket-light Flashlight	46500
Pouch	45272
<i>Replacement tool and blades are also available:</i>	
Punchdown Tool	46020
Punchdown Tool with 66 Blade	46021
66 Style Punchdown Blade	46022
110 Style Punchdown Blade	46024
BIX Style Punchdown Blade	46025
Krone Style Punchdown Blade	46026

### Cable TV Coax Termination Kit



45466

**Application:**

Contains the tools and connectors necessary for installing a Cable TV system.

**Features:**

- Durable Cordura Plus zipper case protects and organizes tools and includes a see-through pouch for storing connectors
- Outside pockets provide convenient storage of instruction manuals or worksite documents

Description	Cat (UPC) No.
Cable TV Coax Termination Kit	45466
<i>Kit contents may be purchased separately:</i>	
Cable Cutter	45482
KWIK STRIPPER™ CATV Stripper, 2 Level Stripper for RG6, RG59, RG7, RG11	45578
KWIK CYCLE® 9" Crimp Frame with Die Set for F-style Connectors on RG6 and RG59 Cable	46801
F Connector Insertion Tool	45516
F-style Crimp-on Connectors for Quad-shield RG6 (Qty. 50)	45324
Zipper Case	45476

### Cable TV Coax Termination and Test Kit



45467

**Application:**

Contains the tools, connectors and tester for installing and testing a Cable TV system.

**Features:**

- Cable TV tone test set uses both electromagnetic and electrostatic pickup to tone through splitters, directional couplers and taps
- Durable Cordura Plus zipper case protects and organizes tools and includes a see-through pouch for storing connectors
- Outside pockets provide convenient storage of instruction manuals or worksite documents

Description	Cat (UPC) No.
Cable TV Coax Termination and Test Kit	45467
<i>Kit contents may be purchased separately:</i>	
Cable Cutter	45482
KWIK STRIPPER CATV Stripper, 2 level stripper for RG6, RG59, RG7, RG11	45578
KWIK CYCLE 9" Crimp Frame with Die Set for F-style Connectors on RG6 and RG59 Cable	46801
F Connector Insertion Tool	45516
F-style Crimp-on Connectors for Quad-shield RG6 (Qty. 25)	45323
Cable TV Tone Generator	402T (60376)
Cable TV Tone Receiver	402R (60377)
Zipper Case	45477

### Coax/Twisted Pair LAN Termination and Test Kit

**Application:**

Provides the essential tools, connectors and testers necessary for maintaining a Local Area Network, twisted pair cabling and coax Ethernet (Thinnet) cabling.

**Features:**

- Durable Cordura Plus carrying case protects and organizes tools and includes a see-through pouch for storing connectors
- Outside pockets provide convenient storage of instruction manuals or worksite documents
- Case has durable handles and eyelets for adding a shoulder strap



45468

Description	Cat (UPC) No.
Coax/Twisted Pair LAN Termination and Test Kit	45468
<i>Kit contents may be purchased separately:</i>	
Cable Cutter	45482
KWIK STRIPPER Twisted Pair Stripper	45579
Punchdown Tool with 110 Blade	46023
66 Style Punchdown Blade	46022
Telephone Ratchet Crimper for 4-, 6- and 8-position Modular Plugs	45575
KWIK STRIPPER Coax Stripper, 3 Level	45577
KWIK CYCLE 9" Crimp Frame with Die Set for BNC-style Connectors on Thinnet RG8 Cable	46800
Center Conductor Cutter for Coax Cable	45481
AdapToner Modular Breakout Tone Generator	AT8 (08693)
Inductive Amplifier Probe	200EP (08671)
BNC-style Coax Connectors for RG58 Thinnet Plenum Cable (Qty. 20)	45781
Category 5 Connectors RJ45, 8 Position (Qty. 50)	45760
Carrying Case	45478



## Voice and Category 5 Data Termination Kit



45469

### Application:

Includes the tools and connectors necessary for installing a voice and data network.

### Features:

- Durable Cordura® Plus zipper case protects and organizes tools and includes a see-through pouch for storing connectors
- Outside pockets provide convenient storage of instruction manuals or worksite documents

Description	Cat (UPC) No.
<b>Voice and Category 5 Data Termination Kit</b>	<b>45469</b>
<i>Kit contents may be purchased separately:</i>	
Cable Cutter	45482
KWIK STRIPPER™ Twisted Pair Stripper	45579
Punchdown Tool with 110 Blade	46023
66 Style Punchdown Blade	46022
Telephone Ratchet Crimper for 4-, 6- and 8-Position Modular Plugs	45575
Category 5 Connectors RJ45, 8 Position (Qty. 50)	45760
Flat Cable Connectors RJ12, 6 Position, 6 Conductor (Qty. 50)	45751
Zipper Case	45479

## Category 5 Data Termination and Test Kit



45470

### Application:

Includes the tools, connectors and testers necessary for installing a Cat 5 data network.

### Features:

- Durable Cordura Plus zipper case protects and organizes tools and includes a see-through pouch for storing connectors
- Outside pockets provide convenient storage of instruction manuals or worksite documents

Description	Cat (UPC) No.
<b>Category 5 Data Termination and Test Kit</b>	<b>45470</b>
<i>Kit contents may be purchased separately:</i>	
Cable Cutter	45482
KWIK STRIPPER Twisted Pair Stripper	45579
Punchdown Tool with 110 Blade	46023
Telephone Ratchet Crimper for 4-, 6- and 8-position Modular Plugs	45575
Category 5 Connectors RJ45, 8 Position (Qty. 50)	45760
Modular Cable Tester Transmitter with Tone Generator	468T (60379)
Modular Cable Tester Receiver	468R (60380)
Zipper Case	45485

## Professional Installation Kit

### Application:

Includes all the tools, connectors and testers for installing and maintaining most types of communications cabling including voice, data and cable TV and coax Ethernet networks.

### Features:

- Durable Cordura Plus carrying case protects and organizes tools and includes see-through pouches for storing connectors
- Outside pockets provide convenient storage of instruction manuals or worksite documents
- Case has durable handles and eyelets for adding a shoulder strap



45471

Description	Cat (UPC) No.
<b>Professional Installation Kit</b>	<b>45471</b>
<i>Kit contents may be purchased separately:</i>	
Cable Cutter	45482
KWIK STRIPPER Twisted Pair Stripper	45579
Punchdown Tool with 110 Blade	46023
66 Style Punchdown Blade	46022
Telephone Ratchet Crimper for 4-, 6- and 8-position Modular Plugs	45575
AdapToner Modular Breakout Tone Generator	AT8 (08693)
Inductive Amplifier Probe	200EP (08671)
PairMapper™ Twisted Pair Fault Tester	45280
PairMapper Remote Terminators 2, 3, 4	45275
KWIK STRIPPER Coax Stripper, 3 Level	45577
KWIK STRIPPER 2-Level Coax Cartridge	45040
KWIK CYCLE® 9" Crimp Frame with Die Set for F-style Connectors on RG6 and RG59 Cable	46801
KWIK CYCLE Die Set for BNC-style Coax Connectors on Thinnet RG8 Cable	46824
Center Conductor Cutter for Coax Cable	45481
F Connector Insertion Tool	45516
F-style Crimp-on Connectors for Quad-shield RG6 (Qty. 50)	45324
Category 5 Connectors RJ45, 8 Position (Qty. 50)	45760
Flat Cable Connectors RJ12, 6 Position, 6 Conductor (Qty. 50)	45751
Carrying Case	45486

### Telecom Technician Pouch



45472

**Application:**

Contains all the essential tools and testers to install and maintain the voice network.

**Features:**

- Durable woven polyester pouch fits any belt up to 5" wide and keeps all the tools conveniently accessible

Description	Cat (UPC) No.
Telecom Technician Pouch	45472
<i>Kit contents may be purchased separately:</i>	
Punchdown Tool with 110 Blade	46023
66 Style Punchdown Blade	46022
Electrician's Scissors	PT-T02 (08708)
Cable Splicer's Knife	PT-T01 (08707)
Tone Generator	77HP (08687)
Inductive Amplifier Probe	200EP (08671)
Telephone Test Set	PE930 (60487)
Cabling Pouch	750C (08685)

### Telecom Field Technician Kit

**Application:**

Contains all the essential tools and testers to maintain a telecommunications network.

**Features:**

- Top quality digital multimeter and telephone test set make troubleshooting a voice network easy
- DMM features an industry-leading lifetime warranty
- Insulated screwdrivers protect the technician up to 10,000V

- Durable Cordura® Plus carrying case protects and organizes tools and includes see-through pouches for storing connectors
- Outside pockets provide convenient storage of instruction manuals or worksite documents
- Case has durable handles and eyelets for adding a shoulder strap

Description	Cat (UPC) No.
Telecom Field Technician Kit	45473
<i>Kit contents may be purchased separately:</i>	
Cable Cutter	45482
Punchdown Tool with 110 Blade	46023
66 Style Punchdown Blade	46022
Electrician's Scissors	PT-T02 (08708)
Cable Splicer's Knife	PT-T01 (08707)
Tone Generator	77HP (08687)
Inductive Amplifier Probe	200EP (08671)
Telephone Test Set	PE930 (60487)
TurTEL6 Modular Adapter and Polarity Tester	46040
Digital Multimeter	DM-800 (07549)
Pocket-light Flashlight	46500
Wire Strippers/Cutter, 10-18 AWG solid, 12-20 AWG stranded	1955 (06857)
Insulated Screwdrivers, 6-piece Set, 1000V Rating	45439
Carrying Case	45487



45473

### Fiber Optic Cut and Strip Kit



45657

**Application:**

Includes three basic tools for cutting and stripping optical fiber cables in a durable Cordura Plus zipper case.

Description	Cat (UPC) No.
Fiber Optic Cut and Strip Kit	45657
<i>Kit contents may be purchased separately:</i>	
Fiber Optic Kevlar® Shears	45586
Stripper for Cable Jackets	1955 (06857)
Fiber Optic Buffer Stripper	45589

### Fiber Optic Hand Tools Kit



45655

**Application:**

Contains the most commonly used fiber optic termination tools in a durable Cordura Plus zipper case.

Description	Cat (UPC) No.
Fiber Optic Hand Tools Kit	45655
<i>Kit contents may be purchased separately:</i>	
Kevlar Shears	45586
Stripper for Cable Jackets	1955 (06857)
Buffer Stripper	45589
Carbide-tipped Scribe	45593
KWIK CYCLE® 8" Crimp Frame with 0.151", 0.178", 0.213" Hex Cavities	45637
Fiber Optic Inspection Microscope	45651
Stainless Steel Polishing Puck	45599
Resilient Polishing Pad, 3" x 8"	45612
Zipper Case	45644

### Fiber Optic Consumables Kit



45656

**Application:**

Contains the most commonly used consumables for epoxy and polish fiber optic terminations.

Description	Cat (UPC) No.
Fiber Optic Consumables Kit	45656
<i>Kit includes the following consumable items which are not sold separately:</i>	
50 Sheets Polishing Paper, 1 micron	
50 Sheets Polishing Paper, 5 micron	
10 ml (0.34 oz.) Opticure Adhesive	
26 ml (0.9 oz.) Opticure Primer	
10 Syringes	
10 Needle Tips	
100 Lint-free Wipes	
10 Alcohol Wipes	

## Fiber Optic Termination Kit

### Application:

Contains all of the tools and consumable materials necessary for epoxy and polish connector terminations.\*

### Features:

- Durable Cordura® Plus carrying case protects and organizes tools and includes see-through pouches for storing connectors
- Outside pockets provide convenient storage of instruction manuals or worksite documents
- Case has durable handles and eyelets for adding a shoulder strap



45658

### Description

### Cat (UPC) No.

Fiber Optic Termination Kit

45658

*Kit contents listed below may be purchased separately:*

Kevlar® Shears

45586

Stripper for Cable Jackets

1955 (06857)

Buffer Stripper

45589

Carbide-tipped Scribe

45593

KWIK CYCLE® 8" Crimp Frame with 0.151", 0.178", 0.213" Hex Cavities

45637

Fiber Optic Inspection Microscope

45651

Stainless Steel Polishing Puck

45599

Resilient Polishing Pad, 3" x 8"

45612

Carrying Case

45639

*Kit includes the following consumable items which are not sold separately:*

50 Sheets Polishing Paper, 0.3 micron

50 Sheets Polishing Paper, 1 micron

50 Sheets Polishing Paper, 5 micron

10 ml (0.34 oz.) Opticure Adhesive

26 ml (0.9 oz.) Opticure Primer

10 Syringes

10 Needle Tips

100 Lint-free Wipes

10 Alcohol Wipes

1 Alcohol Bottle

1 Water Bottle

1 Fiber Debris Disposal Container

1 Pair Safety Glasses

1 Plastic Utility Box

1 Felt-tipped Marker

\*Some connector manufacturers may require alternative tools or materials.



Copper Tools

### Center Conductor Cutter



45481

**Application:**

Precisely trims the center conductor of coaxial cable to a standard length of 3/16" (5 mm).

**Features:**

- Cushioned-grip handle for comfortable use
- Heat-treated for long life

**Specifications:**

- Stamped from high-carbon tool steel
- Rust-resistant black oxide finish

Description	Cat (UPC) No.
Center Conductor Cutter	45481

### Wire Cutter, 30-10 AWG



1915

**Application:**

Cuts 30-10 AWG (0.08-6 mm<sup>2</sup>) copper wire.

**Features:**

- Small, economical wire cutter fits in any tool belt
- Cushioned-grip vinyl handle for comfortable use
- Heat-treated for long life

**Specifications:**

- Stamped and precision ground from high-carbon tool steel
- Return spring
- Pivot joints have hardened steel bushings
- Rust-resistant black oxide finish

Description	Cat (UPC) No.
Wire Cutter, 30-10 AWG	1915 (31892)

### Cable Cutter, 8 AWG



45482

**Application:**

Designed to cut solid, stranded wire up to 8 AWG (10 mm<sup>2</sup>) and multi-conductor cable up to 1/2" (12.7 mm) in diameter.

**Features:**

- Curved cutting blades ensure an easy cut
- Economically priced
- Cushioned-grip handle for comfortable use
- Heat-treated for long life

**Specifications:**

- Stamped and precision ground from high-carbon tool steel
- Return spring
- Locking latch
- Rust-resistant black oxide finish

Description	Cat (UPC) No.
Cable Cutter, 8 AWG	45482



45471

**Professional Installation Kit**

This complete kit includes our 8 AWG Cable Cutter plus all the tools, connectors and testers for installing and maintaining most types of communications cabling. See page 52 for details on our Professional Installation Kit.

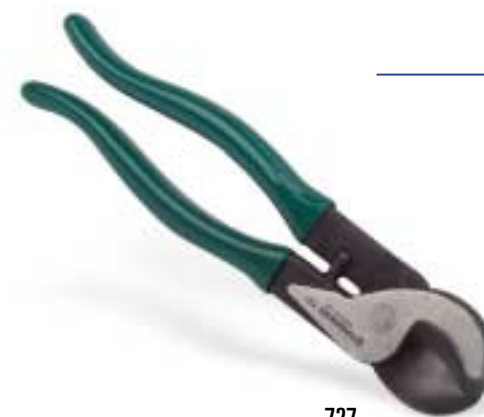

727

### Cable Cutter

**Application:**

Easily cuts heavier copper and aluminum cables up to 2/0 (70 mm<sup>2</sup>).

**Features:**

- Plastic-coated, high-leverage handles for easier cuts
- Heat-treated for long life

**Specifications:**

- Made of heavy-duty forged steel
- Precision ground, shear action, curved cutting blades
- Rust-resistant black oxide finish
- Made in the USA

Description	Cat (UPC) No.
Cable Cutter	727 (31291)

### Cable Splicer's Knife and Electrician's Scissors

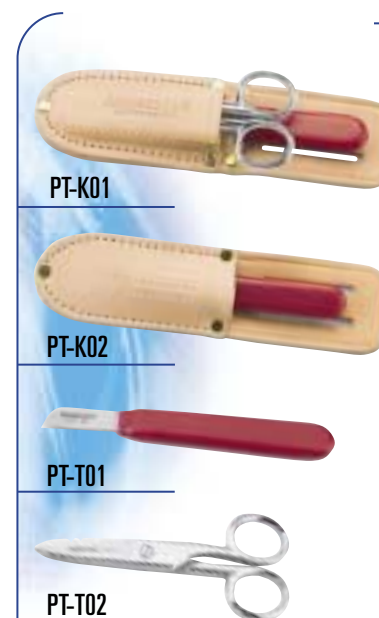

PT-K01

PT-K02

PT-T01

PT-T02

**Application:**

Cuts cable, telephone wire and strips insulation.

**Features:**

- Tough, tempered steel knife blade holds its edge longer
- Full-sized knife handle provides greater comfort

**Specifications:**

- Knife has a coping-type, short blade made of the finest cutlery steel
- Scissors have an upper blade with two stripping notches to strip most insulations from 19-24 AWG

Description	Cat (UPC) No.
Scissors and Knife Kit with Two-pocket Pouch	PT-K01(08704)
Knife Tool Kit with One-pocket Pouch	PT-K02 (08705)
Scissors Tool Kit with One-pocket Pouch (not shown)	PT-K03 (08706)
Cable Splicer's Knife	PT-T01 (08707)
Electrician's Scissors	PT-T02 (08708)

### The TERMINATORS® Wire Strippers/Cutter



1916

**Features:**

- Precision ground blades ensure consistent stripping and cutting
- Heat-treated for long life
- Cushioned-grip vinyl handle for comfortable use

**Specifications:**

- Serrated nose grip for wire pulling and straightening
- Stamped from high-carbon tool steel
- Pivot joints have hardened steel bushings
- Rust-resistant black oxide finish

Description	Cat (UPC) No.
20-10 AWG (0.8 to 2.6 mm dia.) Solid Wire	1916 (31891)
26-16 AWG (0.4 to 1.3 mm dia.) Stranded Wire	1917 (31890)
30-22 AWG (0.25 to 0.64 mm dia.) Solid Wire	1918 (31889)

### Pro Wire Strippers



1950



1955

**Application:**

Strips the outer jacket off both solid and stranded wire.

**Features:**

- Machined stripping stations with a positive stop provide precise stripping diameters
- Ergonomically designed, extra-long cushioned handles add superior comfort and reduce hand fatigue

- Long curved cutter blades reduce force required by 25% and can cut NM in a single cut

- Lock tab protects cutting edges during storage

**Specifications:**

- Pliers nose for working with small nuts and pulling wire
- Hole in jaws for looping wires
- Opening stop prevents spring from disengaging
- Easy-to-read graphics
- Cuts screws

Description	Cat (UPC) No.
Pro Wire Stripper 10-18 AWG	1950 (06852)
Pro Wire Stripper 22-32 AWG	1951 (06853)
Pro Plus Wire Stripper 10-18 AWG	1955 (06857)

### KWIK STRIPPER™ Flat Telephone Cable Cutter/Stripper



**Application:**

Designed to cut and strip flat modular telephone cables (Silver Satin).

**Features:**

- Built-in cable stop/guide for consistent strip length
- Heat-treated for long life
- Cushioned-grip vinyl handle for comfortable use

**Specifications:**

- 2- to 10- conductor capacity
- Stamped from high-carbon tool steel
- Rust-resistant black oxide finish

Description	Cat (UPC) No.
KWIK STRIPPER Flat Telephone Cable Cutter/Stripper	45480

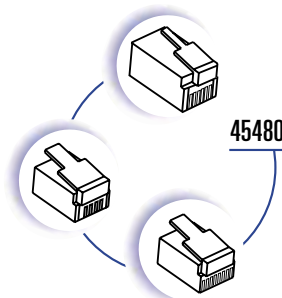

45480

Typically used for Modular Plug Connectors (See page 77).

### KWIK STRIPPER Coax Stripper — 2 Level and 3 Level

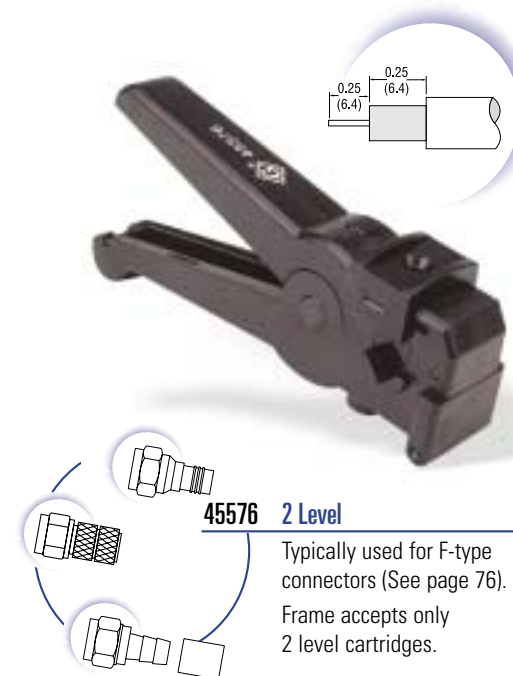

45576 2 Level

Typically used for F-type connectors (See page 76). Frame accepts only 2 level cartridges.

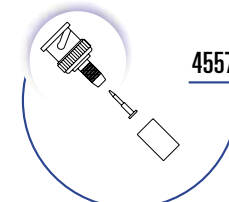

45577 3 Level

Typically used for BNC-type connectors (See page 75). Frame accepts both 2 and 3 level cartridges.

**Applications:**

- Designed to provide precise, repeatable strips consistently
- Prepares RG58, RG59, RG62, RG6 and many other types of coax cable
- Strips braid and dielectric to 1/4" (6.4 mm)

**Features:**

- Blades are easily replaced in the field
- Specifications:**
- Blade adjustment for cutting depth
  - Replaceable and interchangeable blade cassettes

Description	Cat (UPC) No.
KWIK STRIPPER Coax Stripper — 2 Level	45576
KWIK STRIPPER Coax Stripper — 3 Level	45577
Replacement Cartridge — 2 Level	45040
Replacement Cartridge — 3 Level	45039

### KWIK STRIPPER Twisted Pair Stripper

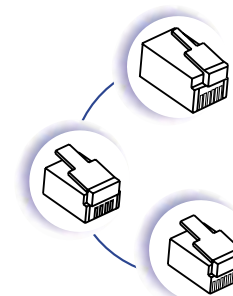

45579

Typically used for Modular Plug Connectors (See page 77).

**Application:**

No tool is better for trimming the jacket from twisted pair cable without damaging the individual conductors.

**Features:**

- Blade depth adjustment ensures precise cutting depth
- Blade penetration controlled by tension loop

**Specifications:**

- Strip length gauge
- Made in the USA

Description	Cat (UPC) No.
KWIK STRIPPER Twisted Pair Stripper	45579

### KWIK STRIPPER™ CATV Cable Stripper

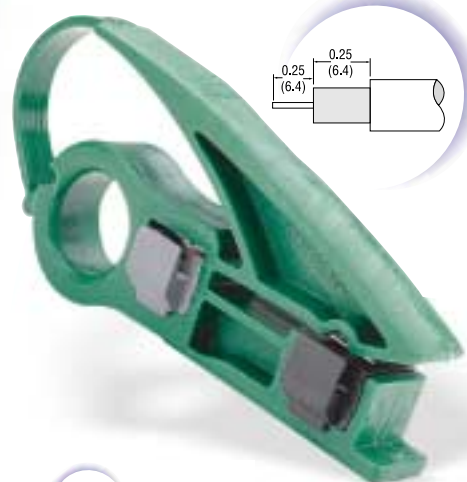

**Application:**

Designed for the professional CATV cable installer, this stripper is perfect for high volume and uses replaceable stripping cartridges for RG6, RG59, RG11 and RG7 CATV cables.

**Features:**

- Pre-measured stops eliminate time-consuming measuring and trimming
- No adjustments needed
- Spare cartridge holder is conveniently built into the tool

**Specifications:**

- Included with the tool, the RG6/RG59 cartridge strips cable jacket and dielectric to ¼" (6.4 mm)
- Included with the tool, the RG11/RG7 cartridge strips cable jacket and dielectric to ¼" (6.4 mm)
- Extra-large finger hole
- Made in the USA

Description	Cat (UPC) No.
KWIK STRIPPER CATV Cable Stripper	45578
Replacement Cartridge RG6/RG59	45580
Replacement Cartridge RG11/RG7	45581

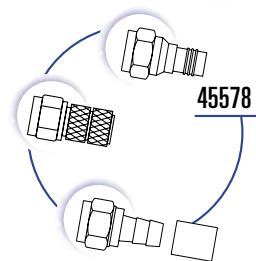

45578

Typically used for F-type connectors (See page 76).

### KWIK STRIPPER CATV/UTP Stripper

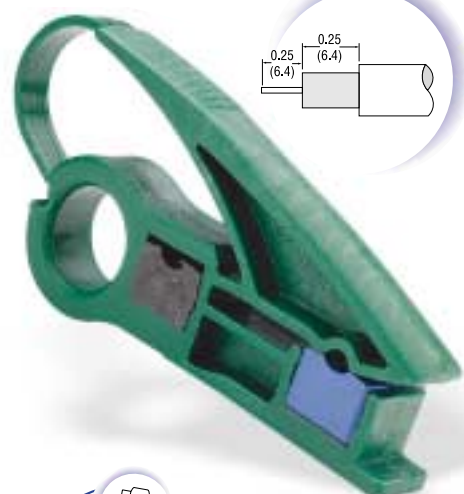

**Application:**

Used for both unshielded twisted pair (UTP) and coaxial cabling, this tool reduces the number of tools needed without any adjustments.

**Features:**

- Switching from four pair UTP to RG6 or RG59 is simple – just change cartridges
- Cartridges are color-coded for quick identification; yellow for UTP and black for coax
- Pre-measured stops eliminate time-consuming measuring and trimming

- UTP cartridge strips four-pair UTP without scoring the individual conductors
- Spare cartridge holder is conveniently built into the tool

**Specifications:**

- Included with the tool, the RG6/RG59 cartridge strips the cable jacket and dielectric to ¼" (6.4 mm)
- Extra-large finger hole
- Made in the USA

Description	Cat (UPC) No.
KWIK STRIPPER CATV/UTP Stripper with Both Cartridges	45677
Replacement Cartridge UTP	45667
Replacement Cartridge RG6/RG59	45580
Replacement Cartridge RG11/RG7	45581

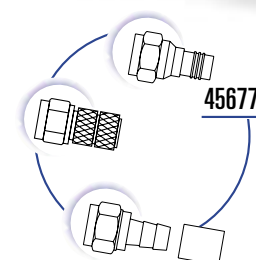

45677

Typically used for F-type connectors (See page 76).  
The most versatile stripper in the industry.



46020

### Punchdown Tool

**Applications:**

- Inserts wire for a corrosion-resistant termination and trims off excess wire
- Terminates 66, 110, BIX and Krone cross-connect and wall jacks

**Features:**

- Spring loaded for fast, low-effort wire seating and termination
- Internal impact mechanism eliminates jamming for longer, trouble-free service life

**Specifications:**

- Adjustable low- and high-impact force settings
- Bayonet-style blade locking mechanism
- Neoprene pad for shock absorption
- Spare blade storage in the handle
- Color-coded yellow on the cut side of tool

Description	Cat (UPC) No.
Punchdown Tool Only	46020
Punchdown Tool w/66 Blade	46021
Punchdown Tool w/110 Blade	46023

### Replacement Blades for the Punchdown Tool



46022



46024



46025



46026

**Features:**

- Cut side labeled to eliminate costly punching errors
- Made of high-carbon tool steel, heat-treated and precision ground for long life

**Specifications:**

- Reversible blades for seating/cut or seating only for jumper wires
- Rust-resistant finish

Description	Cat (UPC) No.
66 Style Blade	46022
110 Style Blade	46024
BIX Style Blade	46025
Krone Style Blade	46026



46010

**Clip-On Twisted Pair Kit**

Our Clip-On Twisted Pair Kit comes with all the tools necessary for terminating voice and data cable including a Punchdown Tool with 110 blade. See page 49 for details.

### Premier Modular Crimper



**Application:**

Use with RJ11, RJ22, RJ45, RJ45 10-position and DEC MMJ offset modular plugs.

**Features:**

- Full-cycle ratchet mechanism provides consistent, quality terminations every cycle
- Straight action ensures uniform crimp

**Specifications:**

- Built-in wire cutter and stripper
- Color-coded, interchangeable crimping dies are available

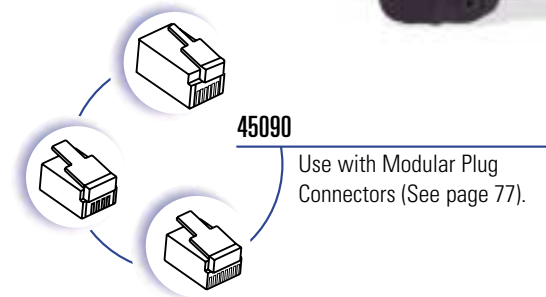

Description	Cat (UPC) No.
Mod Plug Crimper Frame Only	45090
Mod Plug Crimper with RJ11 Crimp Die	45097
Mod Plug Crimper with RJ45 Crimp Die	45098
RJ11 (Blue) Crimp Die Only	45094
RJ22 (Red) Crimp Die Only	45092
RJ45 (Yellow) Crimp Die Only	45091
RJ45 10-Position (White) Crimp Die Only	45095
DEC Offset MMJ Crimp Die Only	45093

### Coax Connector Insertion Tool



**Application:**

Used in CATV applications, the Insertion Tool holds F- and BNC-style connectors securely in place allowing the installer to seat the connector properly on the cable.

**Features:**

- Prevents injury on center conductor
- Screwdriver bit can be removed to allow the ratcheting screwdriver to be used with standard bits
- Screwdriver bit can be purchased separately for use in standard ratcheting screwdrivers
- BNC screwdriver bit sold separately for use with BNC connectors

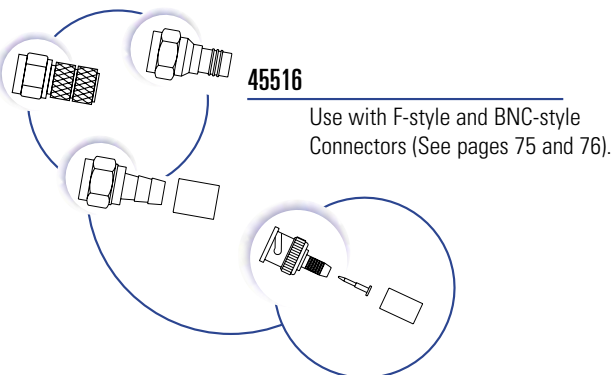

Description	Cat (UPC) No.
Coax Connector Insertion Tool with F-style Connector Bit	45516
Replacement Bit F-style Connector	45517
Replacement Bit BNC-style Connector	45518

### Telephone Ratchet Crimper



**Application:**

Combination tool terminates RJ11 6P4C, RJ12 6P6C and RJ45 8P8C modular style plugs.

**Features:**

- No need to change crimping dies
- Full-cycle ratchet mechanism provides consistent, quality terminations every cycle
- Straight action ensures uniform crimp

**Specifications:**

- Small, compact design
- Built-in wire cutter and stripper
- All-steel frame has rust-resistant, black oxide finish

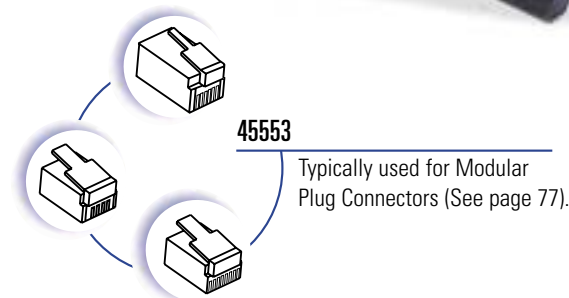

Description	Cat (UPC) No.
Telephone Ratchet Crimper	45553
Telephone Ratchet Crimper	45575

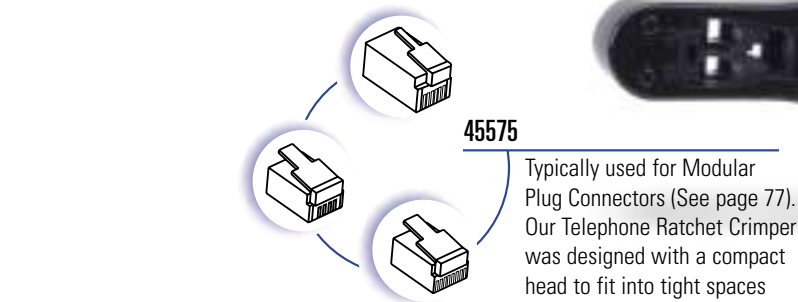

**Voice and Category 5 Data Termination Kit**

This kit includes our Telephone Ratchet Crimper plus other tools and connectors necessary for installing a voice and data network. Everything is conveniently organized in a durable zipper case. See page 51 for details on our Voice and Category 5 Data Termination Kit.



## KWIK CYCLE® 9 Crimp Frame



### Application:

Used to manually crimp a wide variety of connectors and terminals to factory specifications.

### Features:

- Frame features a precision full-cycle ratchet for accurate, repeatable crimps every cycle
- Crimp release lever improves throughput by eliminating rejected terminations due to improper connector positioning
- Frame features a tension adjustment preset at the factory for optimum performance
- High-leverage force and ergonomically-designed handle provides comfortable use
- Frame and dies are manufactured from heat-treated, hardened tool steel for superior function and long life
- All die sets are easily interchangeable with a simple screwdriver

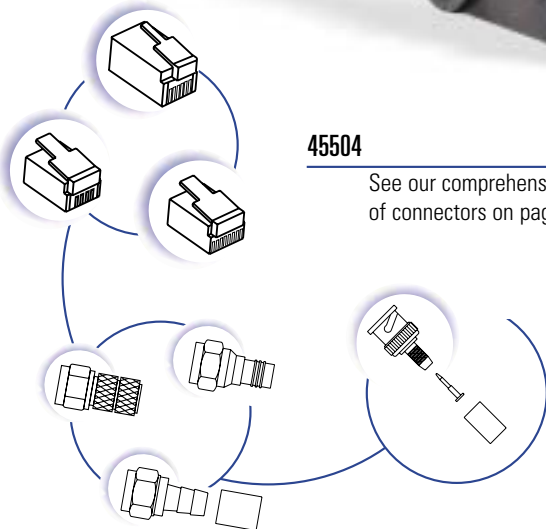

45504

See our comprehensive line of connectors on pages 75 to 77.

Description	Cat (UPC) No.
KWIK CYCLE 9" Crimp Frame	45504

## KWIK CYCLE 9 Interchangeable Die Sets for Coaxial Connectors







Description	CABLE TYPE	CONNECTION	Crimp Profile & Dimensions				Cat (UPC) No.	
			BRAID CRIMP	CENTER CONTACT	TOOL WITH DIE	DIE ONLY		
RG58, RG59 Plenum & Non-plenum Thinwire		BNC/TNC 50/75 OHM	0.213	0.190	0.068	0.042	45556	
RG6, RG174, 8281, AT&T 728		BNC/TNC/F	0.324	0.178	0.068		45582 45557	
RG58/141/142/58Teflon/58 Thinnet/RG59		BNC/TNC/F	0.255	0.213	0.100 0.068	0.052	45558	
RG58/59/G2 Teflon		BNC/TNC from Cambridge/AIM	0.325	0.215	0.065		45559	

## KWIK CYCLE 9 Interchangeable Die Sets for Coaxial Connectors

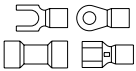
Description	CABLE TYPE	CONNECTION	Crimp Profile & Dimensions				Cat (UPC) No.	
			BRAID CRIMP	CENTER CONTACT	TOOL WITH DIE	DIE ONLY		
RG58/RG59/RG59TFE/RG6		BNC/TNC Cambridge/AIM, 2-piece	0.320	0.210	0.185		45562	
Belden 1694A		BNC/TNC	0.315			0.068	45563	
RG22B/U Twinax & others		Twinax	0.429			0.075 0.075	45574	
RG59, RG62		AMP BNC/TNC Dual Crimp			0.240	0.042 Sq.*	46806	
RG58/RG174/8218		BNC/TNC 50 and 75 OHM		0.213	0.178	0.068 0.042	45544 46826	
RG6/RG59 & 8281		BNC/TNC & F, 50 and 75 OHM. Also 1695, 1505, 9259 and 9231	0.324	0.255		0.068 0.042	45545 46830	
RG58/RG59/G2AU		BNC/TNC	0.256	0.213		0.068	46800 46824	
RG59, RG6		CATV F	0.354	0.324	0.255		46801 46808	
RG58		AMP BNC/TNC				0.218 0.042 Sq.*	46817	
RG59/RG62		BNC/TNC 2-piece Cambridge CP-88-2/89-2	0.319	0.239		0.068	46822	
RG8/RG11/RG213/RG216		N, BNC/TNC	0.429			0.100	46829	
RG174, 8218, AT&T 735A, Mini 59		BNC/TNC		0.178	0.128	0.068	46832	

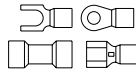
\* This center contact crimp cavity is square style for AMP connectors



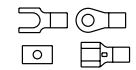



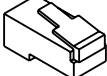

## KWIK CYCLE® 9 Interchangeable Die Sets for Insulated and Non-Insulated Terminals

Description			Cat (UPC) No.	
	CONNECTION	FEATURES	TOOL WITH DIE	DIE ONLY
	22-10 AWG 	Color coded nests for easy identification Standard insulated terminals, ring tongue, spade lug, slide on and butt splices	45500	45509
	22-10 AWG 	Color coded nests for easy identification For fully insulated slide-on style connectors AMP Ultrafast™ style	45501	45570
	26-16 AWG 	For mini insulated terminals with smaller wire barrels Ring tongue, spade, slide on and butt splices		45565
	22-8 AWG 	For non-insulated terminals and splices	45505	45507

## KWIK CYCLE® 9 Interchangeable Die Sets for Open Barrel Contacts

Description			Cat (UPC) No.	
	CONNECTION	FEATURES	TOOL WITH DIE	DIE ONLY
	22-10 AWG (0.3 to 6 mm <sup>2</sup> ) 	Open barrel, non-insulated terminals, ring tongue, spade and slide-on style	45506	45508

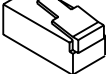
## KWIK CYCLE® 9 Interchangeable Die Sets for Modular Plugs

Description			Cat (UPC) No.	
	CONNECTION	FEATURES	TOOL WITH DIE	DIE ONLY
	RJ45 8-position 	AMP modular plug connectors	45540	46117
	RJ11 4- and 6-position 	AMP modular plug connectors	45541	46118
	RJ11 6-position 	DEC MMJ style connectors with offset release tab		46119
	RJ45 10-position 	Modular plug connectors		45571
	Hand set plug 4-position 			45566

 **GREENLEE**  
DATA • SIGNAL • VOICE  
by WESTINGHOUSE



Fiber Tools

### Fiber Optic Kevlar® Shears

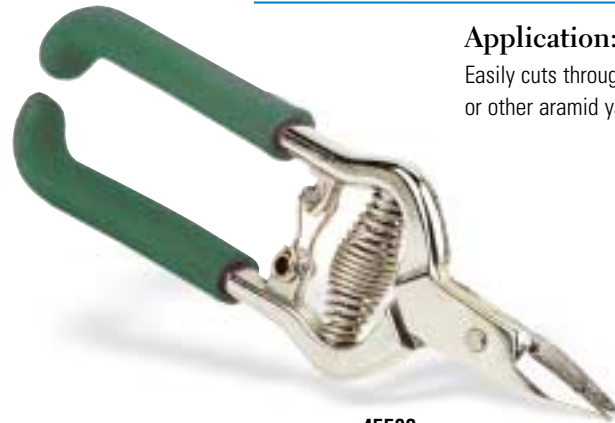

45586

**Application:**

Easily cuts through DuPont Kevlar or other aramid yarn.

**Features:**

- Serrated blade prevents slipping
- High-leverage handles facilitate cutting
- Cushioned-grip handle for comfortable use
- Manufactured from hot-forged, high-carbon steel for long life

Description	Cat (UPC) No.
Fiber Optic Kevlar Shears	45586

### Ceramic Kevlar Cutter



45483

**Application:**

Quickly and precisely trims the Kevlar strength member in fiber optic cable.

**Features:**

- Ceramic blades never need sharpening and have a long life
- Handle is tough and durable

Description	Cat (UPC) No.
Ceramic Kevlar Cutter	45483

Kevlar is a registered trademark of E.I. Dupont, Inc.

### Fiber Optic Carbide-tipped Scribe



45593

**Application:**

Provides consistently good cleaves.

**Features:**

- 30° wedge tip is made of carbide to ensure long life
- Made in the USA

Description	Cat (UPC) No.
Fiber Optic Carbide-tipped Scribe	45593

### Pocket Cable Stripper



1900

**Application:**

Specifically designed for stripping power and telecommunications cables from 3/16" to 1-1/8" in diameter (4.5 mm to 29 mm).

**Feature:**

- Easy blade depth adjustment

**Specification:**

- 90° blade rotation allows longitudinal, circular and spiral slitting of insulation

Description	Cat (UPC) No.
Pocket Cable Stripper	1900 (45824)
Replacement Cutting Blade	07915

### Pocket Cable Stripper



1901

**Application:**

Specifically designed for stripping power and telecommunications cables from 3/4" to 1-1/2" in diameter (19 mm to 40 mm).

**Features:**

- Strips solid conductor, stranded conductor and multiple conductor cables
- Easy blade depth adjustment

**Specification:**

- Blade rotates for circular, longitudinal and spiral cuts

Description	Cat (UPC) No.
Pocket Cable Stripper	1901 (45823)
Replacement Cutting Blade	07915

### Fiber Optic Buffer Stripper



45589

**Application:**

Easily removes the buffer from both 250 and 900 micron cables.

- Will not scratch or nick glass or fiber

**Features:**

- Preset at the factory — no adjustments required
- Cushioned-grip ergonomic handles for comfortable use

**Specifications:**

- 1.0 mm diameter stripping hole strips most fiber jackets
- Made in the USA

Description	Cat (UPC) No.
Fiber Optic Buffer Stripper	45589

### Pro Plus Wire Stripper



1955

**Application:**

Strips the outer jacket off fiber optic cable.

- Lock tab protects cutting edges during storage

**Features:**

- Extra-long, curved and cushioned handles add comfort and reduce hand fatigue

**Specifications:**

- Made in the USA

Description	Cat (UPC) No.
Pro-Plus Wire Stripper, 10-18 AWG	1955 (06857)

### KWIK CYCLE® 9 Crimp Frame



45504

**Application:**

Used to manually crimp a wide variety of connectors and terminals to factory specifications.

**Features:**

- Frame features a precision full-cycle ratchet for accurate, repeatable crimps every cycle
- Crimp release lever improves throughput by eliminating rejected terminations due to improper connector positioning
- Frame features a tension adjustment preset at the factory for optimum performance
- High-leverage force and ergonomically-designed handle provides comfortable use
- Frame and dies are manufactured from heat-treated, hardened tool steel for superior function and long life
- All die sets are easily interchangeable with a simple screwdriver

Description	Cat (UPC) No.
KWIK CYCLE 9" Crimp Frame	45504

### KWIK CYCLE 9 Interchangeable Die Sets for Fiber Optic Connectors

Description		Cat (UPC) No.	
CONNECTION	DESCRIPTION	TOOL WITH DIE	DIE ONLY
	0-style crimp cavities with dimensions of 0.131" x 0.162" x 0.196" (3.33 mm x 4.11 mm x 4.98 mm) For AMP Optimate SMA-style fiber optic connectors		45572
	0.151" (3.84 mm) hex cavity 0.178" (4.52 mm) hex cavity 0.213" (5.41 mm) hex cavity Universal fiber optic die	45637	



45658

#### Fiber Optic Termination Kit

This complete kit contains our KWIK CYCLE 9" Crimp Frame and all of the tools and consumables necessary for epoxy and polish connector terminations. See page 55 for more details about our Fiber Optic Termination Kit.

### Fiber Optic Co-polymer Polishing Puck



45598

**Application:**

Used for standard ST, SC and FC connectors with 2.5 mm ferrules.

Description	Cat (UPC) No.
Fiber Optic Co-polymer Polishing Puck	45598

### Fiber Optic Stainless Steel Polishing Puck



45599

**Application:**

Used for standard ST, SC and FC connectors with 2.5 mm ferrules.

**Features:**

- Made of stainless steel to last for years of termination
- Precision hole prevents even the slightest misalignment
- Grooves in the puck's surface eliminate "sticking" during wet polishes

Description	Cat (UPC) No.
Fiber Optic Stainless Steel Polishing Puck	45599

### Fiber Optic Polishing Pad



45612

**Application:**

Resilient pad is perfect for PC (physical contact) pre-radiused ferrules.

**Specifications:**

- 3" x 8"
- 70 durometer

Description	Cat (UPC) No.
Fiber Optic Polishing Pad	45612

## Fiber Optic Inspection Microscope



45651

### Application:

High-powered microscope is used to check a connector's endface for excess epoxy, core or cladding chips or other irregularities that degrade optical performance of the connector.

### Features:

- Laser safety filter protects eyesight
- Rubber eyecup for comfortable use
- Rugged aluminum housing

### Specifications:

- 200X magnification
- Universal adapter works with ST, SC or FC connectors

#### Description

Fiber Optic Inspection Microscope

#### Cat (UPC) No.

45651

## Connector Cleaning Systems



948

### Application:

Special lint-free fabric-on-a-reel quickly cleans ferrule endfaces of dust, oil and other contaminants.

### Features:

- Cleaning system is completely self-contained
- No need for alcohol
- A single cleaning reel can be used for over 400 ferrule cleanings

### Specifications:

- ReelCleaner™ can be used on all connector types including MTP and MT-RJ

#### Description

ReelCleaner Connector Cleaning System

Replacement Reel Set, 6/Package

#### Cat (UPC) No.

948 (60692)

948/6 (60693)

## Adapter Cleaning Wands



946

### Application:

Specially-created, lint-free materials clean hard-to-reach fiber optic interfaces, bulkhead adapters and ferrule alignment sleeves.

#### Description

2.5 mm Cleaning Wands, 10/Package

2.5 mm Cleaning Wands, 200/Box

1.25 mm Cleaning Wands, 10/Package

1.25 mm Cleaning Wands, 200/Box

#### Cat (UPC) No.

946 (60571)

946K (60689)

947 (60690)

947K (60691)



## Connectors

### BNC Coaxial Connectors

**Features:**

- Gold-plated, captive center contact provides long life and reliable performance
- Precision manufactured from machined brass and nickel plated for corrosion resistance

#### BNC Connectors

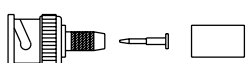
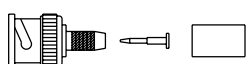
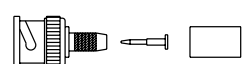
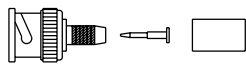
Description			Cat (UPC) No.		Recommended Tool	
CONNECTOR TYPE	CABLE TYPE	QUANTITY		STRIPPER	CRIMPER	
 BNC Crimp Plug	RG58 Thinnet PVC	5/Pack	45730	45577	46800	
 BNC Crimp Plug	RG58 Thinnet Plenum	5/Pack	45731	45577	46800	
 BNC Crimp Plug	RG59/62 PVC	5/Pack	45732	45577	46800	
 BNC Crimp Plug	RG59/62 Plenum	5/Pack	45733	45577	46800	

For the best tools to use with our BNC connectors,

See page 59 for stripping and pages 65 and 66 for crimping.

#### BNC Adapters

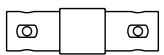
Description		Cat (UPC) No.	
ADAPTER TYPE	QUANTITY		
 BNC Tee-style Plug to Jack/Jack	1/Pack	45727	
 BNC Straight Jack to Jack	1/Pack	45728	

#### BNC Terminators

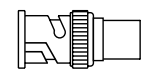
Description		Cat (UPC) No.	
ADAPTER TYPE	QUANTITY		
 BNC Terminator 50 OHM	1/Pack	45725	
 BNC Terminator 93 OHM	1/Pack	45726	

### F-style Coaxial Connectors

**Features:**

- Nickel plated for corrosion resistance

#### F-style Connectors

Description			Cat (UPC) No.		Recommended Tool	
CONNECTOR TYPE	CABLE TYPE	QUANTITY		STRIPPER	CRIMPER	
 'F' Connector Twist-on	RG59	10/Pack 50/Pack	45735 45749	45576 45578 45677		
 'F' Connector Crimp	RG59	10/Pack 50/Pack	45734 45748	45576 45578 45677	46801	
 'F' Connector 1-pc Crimp	RG59	10/Pack 50/Pack	45385 45386	45576 45578 45677	46801	
 'F' Connector 2-pc Crimp	RG59	10/Pack 50/Pack	45317 45318	45576 45578 45677	46801	
 'F' Connector Twist-on	RG6	10/Pack 50/Pack	45327 45328	45576 45578 45677		
 'F' Connector Crimp	RG6	10/Pack 50/Pack	45315 45316	45576 45578 45677	46801	
 'F' Connector 2-pc Crimp	RG6	10/Pack 50/Pack	45319 45320	45576 45578 45677	46801	
 'F' Connector Crimp	RG59 Quad-shield	10/Pack 50/Pack	45321 45322	45576 45578 45677	46801	
 'F' Connector Crimp	RG6 Quad-shield	10/Pack 50/Pack	45323 45324	45576 45578 45677	46801	

#### F-style Adapters and Terminators

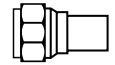
Description		Cat (UPC) No.	
ADAPTER/TERMINATOR TYPE	QUANTITY		
 'F' Female Adapter	5/Pack	45325	
 'F' Terminator	5/Pack	45326	

For the best tools to use with our F-style connectors

See pages 59 and 60 for stripping and pages 65 and 66 for crimping.



## Modular Plugs

### Application:

We offer modular plugs for a wide variety of installations — from simple tasks like connecting a telephone handset cord to the most demanding requirements of Category 5 wiring.

### Features:

- Gold-plated contacts provide long life and reliable performance
- Manufactured to comply with FCC 68 guidelines

### Modular Plug Connectors

Description	Cat (UPC) No.		Recommended			
	CONNECTOR TYPE	CABLE TYPE	QUANTITY	STRIPPER	CRIMPER	COMBO
 Handset 4 Contact	Flat Cable Stranded Wire	25/Pack 50/Pack 100/Pack	45737 45750 45770	45480	45504 w/die 45566	45575
 RJ11 6 Contact	Flat Cable Stranded Wire	25/Pack 50/Pack 100/Pack	45738 45751 45771	45480	45541	45553 45575
 DEC MMJ 6 Contact	Flat Cable Stranded Wire	25/Pack	45739	45480	45504 w/die 46119	
 RJ45 8 Contact	Flat Cable Stranded Wire	25/Pack 50/Pack 100/Pack	45740 45753 45773	45480		45553 45575
 RJ45 Keyed 8 Contact	Flat Cable Stranded Wire	25/Pack 50/Pack 100/Pack	45741 45754 45774	45480		45553 45575
 Handset 4 Contact	Round Cable Solid Wire	25/Pack 50/Pack 100/Pack	45742 45755 45775	45579	45504 w/die 45566	45575 *
 RJ11 6 Contact	Round Cable Solid Wire	25/Pack 50/Pack 100/Pack	45743 45756 45776	45579	45541	45553 * 45575 *
 DEC MMJ 6 Contact	Round Cable Solid Wire	25/Pack	45744	45579		45553 * 45575 *
 RJ45 8 Contact	Round Cable Solid Wire	25/Pack 50/Pack 100/Pack	45745 45758 45778	45579		45553 * 45575 *
 RJ45 Keyed 8 Contact	Round Cable Solid Wire	25/Pack 50/Pack 100/Pack	45746 45759 45779	45579		45553 * 45575 *
 RJ45 Cat 5 8 Contact	Round Cable Solid Wire	25/Pack 50/Pack 100/Pack	45747 45760 45780	45579		45553 * 45575 *

\* Not for use on round cable

For the best tools to use with our modular plugs

See pages 59 to 61 for stripping  
and pages 65 and 66 for crimping.



## Installation Products



### CableCaster™



06186

#### Application:

Significantly speeds up the installation of lightweight communications cable through hard-to-reach spaces such as suspended ceilings, rafters and sub-floors.

#### Features:

- 50' (15 m) range allows for faster installations with fewer pulls
- Bright yellow body reduces chances of leaving the CableCaster behind
- Glow-in-the-dark darts minimize replacement costs because they are easy to locate
- Aerodynamic darts provide high accuracy and fast installation
- Optional flashlight improves visibility

Description	Cat (UPC) No.
CableCaster Wire Pulling Tool with Three Darts	06186
CableCaster Replacement Darts (Pack of Four)	06259
Pocket-light Flashlight	46500

### Fish Tape Selection Guide

LENGTH	Steel		Fiberglass		Nylon		Flex-O-Twist™			
	WITH CASE	WITHOUT CASE	WITH CASE	WITHOUT CASE	WITH REEL	WITH CASE	WITHOUT CASE	WITH CASE	WITHOUT CASE	
25'								539-25 (30161)	439-25 (29516)	
50'	438-5 (29045)	R438-5 (29047)			540-50 (35742)		436-5 (27396)	R436-5 (36850)	539-50 (30162)	439-50 (29517)
100'	438-10 (28256)	R438-10 (28257)	538-10 (30394)	R538-10 (30395)	540-100 (35743)	R540-100 (35744)	436-10 (27397)	R436-10 (36849)	539-100 (34002)	439-100 (29518)
150'									542-150 (35745)	
200'	438-20 (29046)	R438-20 (29048)		R538-20 (30396)					542-200 (35746)	
250'									542-250 (35747)	

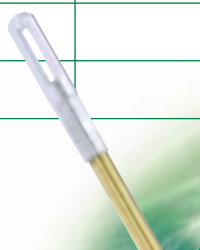
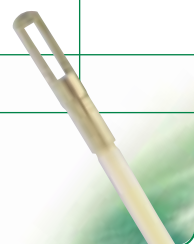
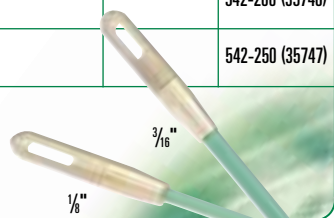
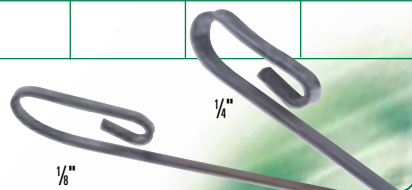

#### Fish Tape Accessories

Greenlee fish tapes are available in a durable case that is specifically designed to withstand the most rigorous jobs. The large handle is made of durable nylon to resist breakage, the feeding assembly reduces jamming and kinking of the tape, and one sight and clearance hole aids in the removal of any foreign objects. Our 3/16" (4.8 mm) fiberglass tapes come in a convenient reel stand.



### Steel Fish Tapes

#### Features:

- High-quality, heat-treated steel for superior strength
- Optional swivel ball for 1/8" tape is designed to twist with the wire during the pull, reducing total pulling friction

#### Specifications:

- Available in two widths: 1/8" x 0.060" (3.2 mm x 1.5 mm) 1/4" x 0.060" (6.4 mm x 1.5 mm)
- Corrosion-resistant finish

#### 12" Flexible Fish Tape Leader

#### Application:

Thread on the end of steel fish tape in place of the swivel ball head to help guide the fish tape through sharp bends.

#### Specifications:

- 12" (305 mm)



439-1 (30859)

Description	Cat (UPC) No.
<b>1/8" (3.2 mm) Tapes</b>	
50' (15.2 m) with Case	438-5 (29045)
50' (15.2 m) without Case	R438-5 (29047)
100' (30.5 m) with Case	438-10 (28256)
100' (30.5 m) without Case	R438-10 (28257)
200' (61 m) with Case	438-20 (29046)
200' (61 m) without Case	R438-20 (29048)
Swivel Ball for 1/8" Steel Tape	R438B (29367)
<b>1/4" (6.4 mm) Tapes</b>	
100' (30.5 m) with Case	538-10 (30394)
100' (30.5 m) without Case	R538-10 (30395)
200' (61 m) without Case	R538-20 (30396)



### Fiberglass Fish Tapes

#### Application:

Designed for use where multiple bends hinder the use of a steel fish tape. Excellent for telecommunications applications.

#### Features:

- Flexible
- Non-conductive

#### Specifications:

- Available in two diameters: 1/8" (3.2 mm) 3/16" (4.8 mm)

Description	Cat (UPC) No.
<b>1/8" (3.2 mm) Tapes</b>	
50' (15.2 m) with Case	540-50 (35742)
100' (30.5 m) with Case	540-100 (35743)
100' (30.5 m) without Case	R540-100 (35744)
<b>3/16" (4.8 mm) Tapes</b>	
150' (45.7 m) with Reel Stand	542-150 (35745)
200' (61 m) with Reel Stand	542-200 (35746)
250' (76.2 m) with Reel Stand	542-250 (35747)



### Nylon Fish Tapes

#### Application:

Fish steel and PVC conduit with multiple bends easier when installing any wire or cable.

#### Features:

- Flexible
- Non-conductive

#### Specifications:

- 3/16" (4.8 mm) diameter

Description	Cat (UPC) No.
<b>3/16" (4.8 mm) Tapes</b>	
50' (15.2 m) with Case	436-5 (27396)
50' (15.2 m) without Case	R436-5 (36850)
100' (30.5 m) with Case	436-10 (27397)
100' (30.5 m) without Case	R436-10 (36849)



### Flex-O-Twist Flexible Steel Fish Tapes

#### Application:

Designed for multiple bends where flat steel fish tapes may not work.

#### Features:

- Flexible steel slips through lateral and vertical bends in the same run
- Steel cable is strong enough to pull up to 500 lbs

#### Specifications:

- 3/16" x 0.060" (4.8 mm x 1.5 mm)
- Multi-strand steel cable

Description	Cat (UPC) No.
<b>3/16" (4.8 mm) Tapes</b>	
25' (7.6 m) with Case	539-25 (30161)
25' (7.6 m) without Case	439-25 (29516)
50' (15.2 m) with Case	539-50 (30162)
50' (15.2 m) without Case	439-50 (29517)
100' (30.5 m) with Case	539-100 (34002)
100' (30.5 m) without Case	439-100 (29518)



## The Original D'versiBIT® System

### Features:

- Saves time and eliminates frustration while fishing wire or cable through existing walls
- Simple to use — just bow the sprint steel shaft in the direction you want to drill
- Field proven to deliver accurate and professional results in many applications
- D'versiBITS are available in three different types for a variety of materials

### Specifications:

- ¼" to 1" (6.4 mm to 25.4 mm) in diameter and in shaft lengths from 18" to 72" (45.72 mm to 1828.8 mm)

### Types of D'versiBITS

Color Code	Bit Diameter		Shaft Length		Shaft Diameter		Type A	Type B	Type C
	In	mm	In	mm	In	mm	Wood-type Auger Bit	Combination Screw Point Bit	Combination Bit for Wood
Black	¾"	9.5	54	1371.6	⅜"	4.8	06-03-54A (38068)	06-03-54B (38093)	06-03-54C (38118)
			72	1828.8	⅜"	4.8	06-03-72A (38069)	06-03-72B (38094)	06-03-72C (38119)
Green	½"	12.7	54	1371.6	⅜"	4.8	08-03-54A (38073)	08-03-54B (38098)	08-03-54C (38123)
			72	1828.8	⅜"	4.8	08-03-72A (38074)	08-03-72B (38099)	08-03-72C (38124)
Orange	⅝"	14.3	54	1371.6	⅜"	4.8	09-03-54A (38078)	09-03-54B (38103)	09-03-54C (38128)
Red	¾"	19.1	54	1371.6	¼"	6.4	12-04-54A (38083)	Not Available	12-04-54C (38133)
White	1"	25.4	54	1371.6	¼"	6.4	16-04-54A (38088)	Not Available	16-04-54C (38138)



Wood-type Auger Bit with screw point works well for soft woods and thin sections



Combination Screw Point Bit is perfect for easy starting and pulling through wood



Combination Bit for Wood



Flexible steel drill bits are perfect for installing wire or cable inside existing walls.

## D'versiBIT Placement Tool

### Application:

Allows vertical and horizontal placement of the drill bit at any point within the wall.

### Features:

- Helps to avoid accidental drilling through the wall



712P

Description	Cat (UPC) No.
D'versiBIT Placement Tool	712P (38350)

## D'versiBIT Extensions

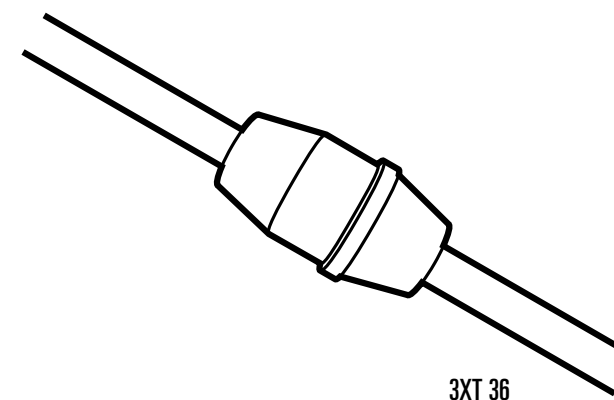

3XT 36

### Application:

Connect to chuck end of D'versiBIT shaft to increase the length of the bit.

D'versiBIT Shaft Dia.	D'versiBIT Length	Cat (UPC) No.
⅜" (4.8 mm)	36" (0.9 m)	3XT 36 (38685)
⅜" (4.8 mm)	54" (1.4 m)	3XT 54 (38686)
⅜" (4.8 mm)	72" (1.8 m)	3XT 72 (38687)
¼" (6.4 mm)	36" (0.9 m)	4XT 36 (38688)
¼" (6.4 mm)	54" (1.4 m)	4XT 54 (38689)
¼" (6.4 mm)	72" (1.8 m)	4XT 72 (38690)

## Abrasion Shield



606AS

### Application:

Protects shaft of masonry bits as they turn against masonry walls during drilling.

Description	Cat (UPC) No.
Abrasion Shield	606AS (38696)

## D'versiGRIP Wire and Cable Pulling Grips

### Features:

- Swivel action reduces twisting during wire or cable recovery
- Clip attaches to hole in bit, and the mesh basket holds the wire or cable

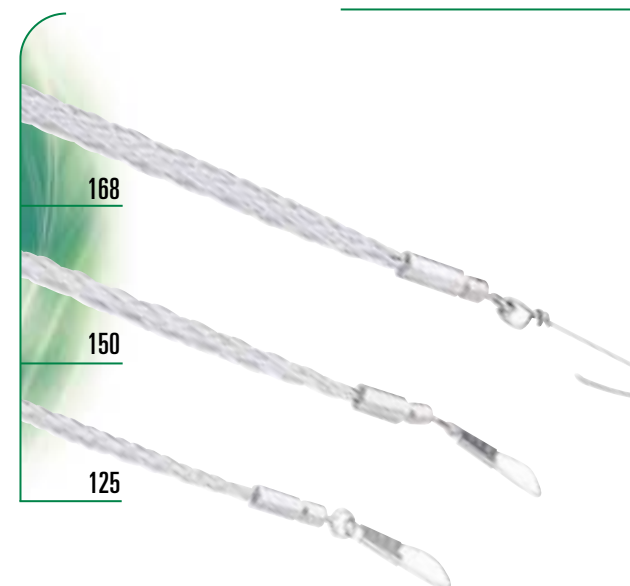

168

150

125

Description	Cat (UPC) No.
D'versiGRIP for Pulling Single Wire with ⅜" to ½" Bits (9.5 mm to 12.7 mm)	125 (38691)
D'versiGRIP for Pulling ½" OD Wire (12.7 mm) with ½" to ⅝" Bits (12.7 mm to 14.3 mm)	150 (38692)
D'versiGRIP for Pulling ¾" OD Wire (19.1 mm) with ¾" to 1" Bits (19.2 mm to 25.4 mm)	168 (38693)

## Fiber Optic Cable Puller

### Application:

Designed to meet the unique pulling requirements of fiber optic or any other type of communication cable.

### Features:

- Both speed and maximum pulling force can be set by the operator
- Electronically displays both actual speed and actual force while running
- Shuts down when maximum preset force is reached to prevent damage to the cable being pulled (200 to 800 lbs adjustment range [90.7 to 363 kg])
- Gradual restart after automatic shutdown prevents quick snap stressing
- Ports provided to link to optional strip recorder for permanently documenting pulling force or speed
- Dual-grooved capstans provide excellent rope control

### Specifications:

- Pulling speed of 10' to 75' per minute (3 m to 23 m per minute)
- Includes puller mounting bracket, mounting chain and steel storage case (120V)

Description	Cat (UPC) No.
Fiber Optic Puller	805 (33678)
Boom Mount for Use with 441 Feeding Sheave	33656
On/Off Foot Switch	33629
Chart Recorder	33901
Chart Recorder Cable	86332
Paper for Chart Recorder	86328

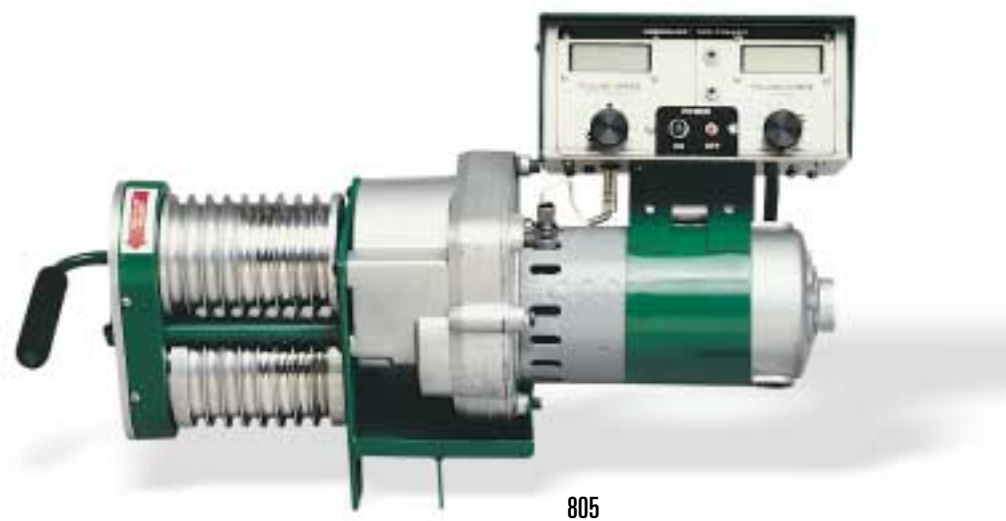

805

## Fiber-Gel™

### Application:

Synthetic gel is specially designed for light-weight fast pulling of fiber optic cables.

### Features:

- Dries slowly and leaves a long-lasting lubricating film
- Cleans up easily

### Specifications:

- Compatible with all cable jackets
- Compatible with pre-lubricated innerducts
- Environmentally safe
- Operating range from 32° F to 190° F (0° C to 88° C)

Description	Cat (UPC) No.
Fiber-Gel One Quart Squeeze Bottle (0.95 L)	FIBR-Q (02040)
Fiber-Gel One Gallon (3.79 L)	FIBR-1 (02041)
Fiber-Gel Five Gallons (18.93 L)	FIBR-5 (02045)



FIBR-5

FIBR-Q

FIBR-1

## Clear Lube™

### Application:

Designed for use within electrical or datacom cable pulls.

### Features:

- Clear and colorless for quick, easy clean-up
- Excellent lubricity for fast pulls (0.27 to 0.29 COF)

- Environmentally safe, non-hazardous, non-toxic and non-corrosive
  - Easy to apply either by hand, brush or pump
- ### Specifications:
- Remains stable over a wide range of temperatures, 20° F to 190° F (-6° C to 190° C)
  - Polymer base with no silicon additives
  - Average coefficient of friction (per IEEE, 375-2 test procedure), 0.27 in PVC and 0.29 in EMT
  - Three-year shelf life with no deterioration in lubricant



CLR-5

CLR-1

CLR-Q

Description	Cat (UPC) No.
Clear Lube Pulling Lubricant, 1 Quart (0.95 L)	CLR-Q (10437)
Clear Lube Pulling Lubricant, 1 Gallon (3.79 L)	CLR-1 (10438)
Clear Lube Pulling Lubricant, 5 Gallon (18.93 L)	CLR-5 (10439)

## Poly Line

### Application:

Perfect for most DSV fishing needs to pull rope through conduit. Not suitable for pulling wire or cable.

### Features:

- Poly Line can be used with power fishing systems directly from the container
- Resists tangling when dispensing

- Reusable plastic dispenser pail keeps the line dry
- Rot and mildew resistant

Length	Avg Breaking Strength	Cat (UPC) No.
6,500' (1981 m)	210 lbs (934 N)	430 (21481)
5,200' (1585 m)	240 lbs (1 kN)	431 (21482)
2,200' (670 m)	500 lbs (2.2 kN)	37959



430

## Polyester Measure/Pulling Tape

### Application:

Two-in-one tool to measure run length and pull cable.

### Features:

- Durable and stretch resistant tape for easily pulling and installing wire and fiber optic cables within PVC and HDPE ducts
- Factory lubricated to reduce burn-through in innerduct
- Easy-to-read footage markings for quick and accurate measurements
- Available in various tensile strengths for use in any application

### Specifications:

- Treated with silicone lubricant that is compatible with all innerduct lubricants



4436

Avg Breaking Strength	Length x Width (approx.)	Cat (UPC) No.
1,250 lbs (5.56kN)	3,000' (914 m) x 1/2" (12.7 mm)	4435 (10445)
1,800 lbs (8.01 kN)	3,000' (914 m) x 5/8" (15.9 mm)	4436 (10446)
2,500 lbs (11.12 kN)	3,000' (914 m) x 3/4" (19.1 mm)	4437 (10447)

### Data Cable Caddy

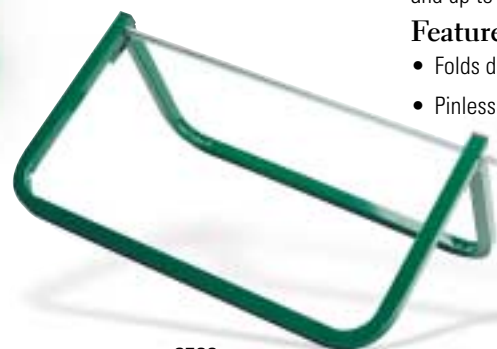

9520

**Application:**

Perfect for communication spools 6" wide and up to 19" in diameter.

**Features:**

- Folds down for easy storage
- Pinless design eliminates loose parts

**Specifications:**

- 21" long x 28½" wide x 11½" high (533 mm long x 724 mm wide x 292 mm high)

- Caddy weighs 11 lbs (5 kg)

**Spool Capacity:**

- 100 lbs maximum total spool weight (45.4 kg)
- 19" maximum spool diameter (483 mm)

Description	Cat (UPC) No.
Data Cable Caddy	9520 (01228)

### Folding Hand Caddy



9501

**Application:**

Holds up to six spools of #10 wire.

**Features:**

- Folds down to 2½" for easy storage
- Pinless design eliminates loose parts

**Specifications:**

- 10" wide x 18½" high (254 mm wide x 470 mm high)

- Caddy weighs 6 lbs (2.7 kg)

**Spool Capacity:**

- 100 lbs maximum total spool weight (45.4 kg)
- 19" maximum spool diameter (483 mm)

Description	Cat (UPC) No.
Folding Hand Caddy	9501 (01202)

### Hand Truck Wire Cart



38733

**Application:**

Stores and dispenses up to 15 spools of #14 THHN wire.

**Features:**

- Heavy-duty wheels for durability and easy transporting
- Dual heavy-duty wire guides dispense wires in all directions
- Only 23" wide to fit easily through narrow doorways
- Storage space for three spindles and clips eliminates loose parts when they are not in use

**Specifications:**

- Five ¾" diameter reel spindles
- 22½" long x 23" wide x 46" high (571.5 mm long x 584.2 mm wide x 1,168 mm high)
- Cart weighs 58 lbs (26.3 kg)

- Spool Capacity:**
- Two 1,000' spools (305 m) up to 22" dia. x 16½" wide (558.8 mm dia. x 416 mm wide)
  - Three 2,500' spools (762 m) up to 14" dia. x 16½" wide (355.6 mm dia. x 416 mm wide)
  - Ten 500' spools (152 m) up to 7" dia. x 8" wide (177.8 mm dia. x 203.2 mm wide)
  - Fifteen 500' spools (152 m) up to 7" dia. x 5½" wide (177.8 mm x 136.5 mm)

Description	Cat (UPC) No.
Hand Truck Wire Cart	38733

### Hand Truck Caddy



9505

**Application:**

Stores and dispenses up to 12 spools of #12 AWG wire or eight spools of #10 AWG wire.

**Features:**

- 10" diameter pneumatic tires facilitate jobsite portability
- Pinless design eliminates loose parts
- Multi-use caddy can lay flat for dispensing wire or be used upright as a hand caddy

**Specifications:**

- Four solid steel ½" diameter reel spindles
- 46½" long x 28½" wide (1,180 mm long x 71.8 mm wide)
- Caddy weighs 32 lbs (14.5 kg)

**Spool Capacity:**

- 200 lbs maximum total spool weight (90.7 kg) or 4,000' (1,219.2 m) of #10 AWG wire
- 7½" maximum spool diameter (190 mm)
- 250 lbs maximum dolly lift (113.4 kg)

Description	Cat (UPC) No.
Hand Truck Caddy	9505 (01205)

### Wire Cart



911

**Application:**

Our highest-capacity cart is excellent for storing, transporting or feeding large quantities of wire.

**Features:**

- Cart can be used vertically or horizontally to save space
- Built-in wire guide facilitates horizontal dispensing
- Five strong reel axles with spring clip retainers plus two positions for axle storage allow for configuration of large reels with no loose parts
- Fits through 28" (711.2 mm) openings

**Specifications:**

- Made of strong, yet lightweight, tubular steel welded construction with rugged 8" (203.2 mm) wheels.
- 54½" long x 27" wide x 26½" high when horizontal (1384.3 mm long x 685.8 mm wide x 673.1 mm high)
- Cart weighs 62 lbs (28.12 kg)

**Spool Capacity:**

- Six 2,500' spools (762 m) up to 16" dia. (406 mm)
- Six 500' spools (152.4 m) up to 8" dia. (203 mm)

Description	Cat (UPC) No.
Wire Cart	911 (31518)
Reel Shaft (Qty. 5)	31523
Hitch Clip (Qty. 10)	50303

### KWIK CYCLE® Cable Tie Guns



45306

**Application:**

The Standard Cable Tie Gun is for use with ¼" to ⅝" wide cable ties (2.2 mm to 4.8 mm), and the gun is made of molded nylon.

The Heavy-duty Cable Tie Gun is for use with cable ties up to ¼" wide (6.35 mm), and the gun is made of durable metal.

**Features:**

- Tension adjustment allows the user to adapt the tool to the size of the tie
- Automatic cut-off eliminates sharp edges on ties

Description	Cat (UPC) No.
Standard Cable Tie Gun	45306
Heavy-duty Cable Tie Gun	45300

Index Header	Product(s) Entries	Page No.
AC/Main Power Converter 120V for Handheld Fiber Testers	16, 17, 18, 20, 21, 23, 25, 26, 27, 28	
<b>Adapters, Fiber Optic Instruments</b>		
Adapter Cleaning Wands	73	
Bare Fiber Adapter	24	
fiberSAFE™ LAN Adapter Kits — SOC and UCI	31	
fiberSAFE USA/Canada Telecom Adapter Kits — SOC and UCI	31	
fiberSAFE Worldwide Telecom Adapter Kits — SOC and UCI	31	
SOC Adapters	29, 30	
SOC Adapter Tool	30	
UCI Adapters	29	
UPI-PC Adapters	30	
<b>Cable Locators</b>		
Buried Line Locator	45	
Omni Marker™	47	
Pulser	46	
Tracker II	45	
Uni Marker™	47	
Wire Finder/Mini Locator	46	
<b>Cable Testers</b>		
Coaxial Cable Tester	6	
Modular Cable Tester/Tone Generator	7	
PairMapper® Twisted Pair Fault Tester with Remote 1	8	
PROSCANNER® Network Cable Test Kit	8	
Sure Signal™ Line Verifier and Patch Cord Tester	7	
<b>Cable Tie Guns</b>		
KWIK CYCLE® Heavy-duty Cable Tie Gun	86	
KWIK CYCLE Standard Cable Tie Gun	86	
<b>CableCaster™</b>		
CableCaster	79	
Pocket-light Flashlight	79	
Replacement Darts for CableCaster	79	
<b>Caddies and Carts</b>		
Data Cable Caddy	85	
Folding Hand Caddy	85	
Hand Truck Caddy	86	
Hand Truck Wire Cart	85	
Wire Cart	86	
<b>Carrying Cases</b>		
Cable TV Coax Termination and Test Kit Zipper Case	50	
Cable TV Coax Termination Kit Zipper Case	49	
Cabbling Pouch	43	
Category 5 Data Termination and Test Kit Zipper Case	51	
Coax/Twisted Pair LAN Termination and Test Kit Carrying Case	50	
Fiber Optic Hand Tools Kit Zipper Case	54	
Fiber Optic Termination Kit Carrying Case	55	
fiberTOOLS™ Hard Carrying Cases	28	
fiberTOOLS Soft Carrying Cases	28	
Holster for A-Bug® Tone Probe	43	
Holster for A-Bug Tone Sender	43	
Modular Cable Tester/Tone Generator Carrying Case	7	

Index Header	Product(s) Entries	Page No.
NETcat® LAN Trouble Shooter Vinyl Carrying Case	9	
PairMapper Twisted Pair Fault Tester Carrying Case	8	
Professional Installation Kit Carrying Case	52	
PROSCANNER™ Carrying Case	8	
Sure Signal Carrying Case	7	
Telecom Field Technician Kit Carrying Case	53	
Tone and Probe Carrying Case	43	
Voice and Category 5 Data Termination Kit Zipper Case	51	
<b>Coax Connector Insertion Tool</b>		
Coax Connector Insertion Tool	63	
Replacement Bits for Coax Connector Insertion Tool	63	
<b>Coaxial Cable Tester</b>		
Coaxial Cable Tester	6	
<b>Connector Cleaning Systems</b>		
Adapter Cleaning Wands	73	
ReelCleaner Connector Cleaning System	73	
Replacement Reel for ReelCleaner	73	
<b>Connectors</b>		
BNC Adapters	75	
BNC Coaxial Connectors	75	
BNC Terminators	75	
F-style Adapters and Terminators	76	
F-style Coaxial Connectors	76	
Modular Plug Connectors	77	
<b>Copper Kits</b>		
Cable TV Coax Termination and Test Kit	50	
Cable TV Coax Termination Kit	49	
Category 5 Data Termination and Test Kit	51	
Clip-on Twisted Pair Kit	49	
Coax/Twisted Pair LAN Termination and Test Kit	50	
Professional Installation Kit	52	
Telecom Field Technician Kit	53	
Telecom Technician Pouch	53	
Voice and Category 5 Data Termination Kit	51	
<b>Crimpers</b>		
KWIK CYCLE 9 Crimp Frame	65, 71	
KWIK CYCLE 9 Interchangeable Die Sets for Coaxial Connectors	65, 66	
KWIK CYCLE 9 Interchangeable Die Sets for Fiber Optic Connectors	71	
KWIK CYCLE 9 Interchangeable Die Sets for Insulated and Non-Insulated Terminals	67	
KWIK CYCLE 9 Interchangeable Die Sets for Modular Plugs	67	
KWIK CYCLE 9 Interchangeable Die Sets for Open Barrel Contacts	67	
Premier Modular Crimper	63	
Premier Modular Plug Crimper Dies	63	
Telephone Ratchet Crimper	64	
<b>Cutters</b>		
Cable Cutter	58	
Cable Cutter, 8 AWG	57	
Cable Splicer's Knife	58	
Center Conductor Cutter	57	
Ceramic Kevlar® Cutter	69	
Electrician's Scissors	58	

Index Header	Product(s) Entries	Page No.
Fiber Optic Kevlar Shears	69	
Knife Tool Kit with One-pocket Pouch	58	
Scissors and Knife Kit with Two-pocket Pouch	58	
Scissors Tool Kit with One-pocket Pouch	58	
The TERMINATORS® Wire Strippers/Cutter	58	
Wire Cutter, 30-10 AWG	57	
<b>D'versiBIT® System</b>		
D'versiBIT Abrasion Shield	82	
D'versiBIT, Combination Bit for Wood	81	
D'versiBIT, Combination Screw Point Bit	81	
D'versiBIT Extensions	82	
D'versiBIT Placement Tool	81	
D'versiBIT, Wood-type Auger Bit	81	
<b>D'versiGRIP Wire and Cable Pulling Grips</b>		
D'versiGRIP Wire and Cable Pulling Grips	82	
<b>Fault Locators and Light Detectors</b>		
FC-PC Visual Fault Finder	23	
MicroOTDR™ Optical Fault Locator	24	
MT-RJ Visual Fault Finder	23	
SensOLITE® Light Detector	24	
SOC-2 Adapters for Visual Fault Finder	22	
Visual Fault Finder	22	
Visual Fault Finders for 2.5 mm and 1.25 mm Connectors	23	
<b>Fiber Kits</b>		
Fiber Optic Consumables Kit	54	
Fiber Optic Cut and Strip Kit	54	
Fiber Optic Hand Tools Kit	54	
Fiber Optic Termination Kit	55	
<b>Fiber Optic Cable Puller</b>		
Boom Mount for Fiber Optic Cable Puller	83	
Chart Recorder Cable for Fiber Optic Cable Puller	83	
Chart Recorder for Fiber Optic Cable Puller	83	
Fiber Optic Cable Puller	83	
On/Off Foot Switch for Fiber Optic Cable Puller	83	
Paper for Fiber Optic Cable Puller Chart Recorder	83	
<b>Fiber Optic Carbide-tipped Scribe</b>		
Fiber Optic Carbide-tipped Scribe	69	
<b>Fiber Optic Inspection Microscope</b>		
Fiber Optic Inspection Microscope	73	
<b>Fiber Optic Polisher</b>		
Fiber Optic Co-polymer Polishing Puck	72	
Fiber Optic Polishing Pad	72	
Fiber Optic Stainless Steel Polishing Puck	72	
<b>Fiber Optic Test Probes</b>		
FoPro® with 1.25 mm Ferrule, Multimode	32	
FoPro with 1.25 mm Ferrule, Single-mode	32	
FoPro with 2.5 mm Ferrule, Multimode	32	
FoPro with 2.5 mm Ferrule, Single-mode	32	
FoPro with MIL-style 1.57 mm Ferrule, Multimode	32	
FoPro with MIL-style 1.57 mm Ferrule, Single-mode	32	
<b>FIBERcat® Optical Loss Test Kit</b>		
FIBERcat Optical Loss Test Kit	11	

Index Header	Product(s) Entries	Page No.
Simplex Patch Cables for FIBERcat	11	
ST Fiber Test Kit for FIBERcat	11	
<b>FIBERcat Test &amp; Talk Fiber Certification System</b>		
FIBERcat Test & Talk	11	
LANcat® System 6 w/ Test & Talk	11	
Simplex Patch Cable for FIBERcat	11	
ST Fiber Test Kit for FIBERcat	11	
<b>FiberMeter Fiber Certification System</b>		
FiberMeter Fiber Certification System	14	
<b>Fish Tapes</b>		
Fiberglass Fish Tapes	80	
Flex-O-Twist™ Steel Fish Tapes	80	
Nylon Fish Tapes	80	
Steel Fish Tapes	80	
Swivel Ball for 1/8" Steel Fish Tapes	80	
<b>Inductive Amplifiers</b>		
A-Bug Tone Probe	43	
A-Bug Tone Probe — Filtered	43	
200 Series Inductive Amplifiers	39	
Filter Probe	40	
Replacement Metal Tips for 200B and 200EP Probes	40	
Replacement Plastic Tips for 200 Series Probes	40	
<b>ISDN Test Set</b>		
ISDN Test Set	4	
<b>LANcat Network Cable Tester and Talk Set</b>		
110 Block Connecting Module Option for LANcat System 5 and 6	10	
Coax Cable Testing Module Option for LANcat System 5 and 6	10	
Handset Cover for LANcat System 5 Handsets	10	
Installers Kit for LANcat System 5 and 6	10	
LANcat System 5	10	
LANcat System 6	10	
NiMH Rechargeable Battery Pack for LANcat System 5 and 6	10	
<b>Laser Sources</b>		
Dual Wavelength Laser Source, 1310/1550nm	27	
Single Wavelength Laser Source, 1310nm, Single-mode	28	
Single Wavelength Laser Source, 1550nm, Single-mode	28	
<b>LED Sources</b>		
Dual Wavelength LED Source, 850/1300nm	25	
MT-RJ Dual Channel LED Source, 1300nm	26	
MT-RJ Dual Channel LED Source, 850nm	26	
Single Wavelength LED Source, 650nm	26	
<b>Measuring/Pulling Tape</b>		
Polyester Measuring/Pulling Tape	84	
<b>Modular Cable Tester/Tone Generator</b>		
Carrying Case for Modular Cable Tester/Tone Generator	7	
Modular Cable Tester/Tone Generator	7	
<b>NETcat® LAN Trouble Shooter</b>		
NETcat LAN Trouble Shooter	9	
NETcat Plus LAN Trouble Shooter	9	
Token Ring Adapter for NETcat and NETcat Plus LAN Trouble Shooter	9	
Vinyl Carrying Case for NETcat LAN Trouble Shooter	9	

Index Header	Product(s) Entries	Page No.	Index Header	Product(s) Entries	Page No.
<b>Office Identifier Kit</b>					
	Grounding Cord Assembly for Office Identifier Kit	8		Pocket Cable Strippers	70
	Office Identifier Kit	8		Pro Plus Wire Stripper	59, 70
<b>Optical Loss Test Sets</b>				Pro Wire Strippers	59
	Advanced Single-mode Optical Loss Test Set	15		Replacement Cartridges for KWIK STRIPPER CATV Cable Stripper	61
	fiberTOOLS® MT-RJ Optical Loss Test Sets, Dual Wavelength, Multimode, Basic	18		Replacement Cartridges for KWIK STRIPPER CATV/UTP Stripper	61
	fiberTOOLS MT-RJ Optical Loss Test Sets, Dual Wavelength, Multimode, Deluxe	18		Replacement Cartridges for KWIK STRIPPER Coax Stripper	60
	fiberTOOLS MT-RJ Optical Loss Test Sets, Single Wavelength, Multimode	18		Replacement Cutting Blade for Pocket Cable Strippers	70
	fiberTOOLS Multimode Optical Loss Test Sets, Basic	17		The TERMINATORS® Wire Strippers/Cutter	58
	fiberTOOLS Multimode Optical Loss Test Sets, Deluxe	17	<b>Sure Signal™</b>		
	fiberTOOLS Single-mode Optical Loss Test Sets, Basic	16		Sure Signal Accessory Kit	7
	fiberTOOLS Single-mode Optical Loss Test Sets, Deluxe	16		Sure Signal Carrying Case	7
<b>Optical Power Meters</b>				Sure Signal Remote	7
	Advanced Optical Power Meters	19		Sure Signal Line Verifier and Patch Cord Tester	7
	Ge MT-RJ Optical Power Meter	20	<b>T-Bug® Digital Signal Identifier</b>		5
	High Intensity InGaAs Optical Power Meter	21	<b>Tele-Mate Communication Test Set</b>		4
	InGaAs Optical Power Meter	20	<b>Telephone Test Sets</b>		
	Silicon Optical Power Meter	21		Harrier ISDN Test Set	4
<b>P-Phone Adapters</b>				Ground Start Cordset for PE900 Series Telephone Test Sets	3
	Clip-to P-Phone Adapter with 5' OSP Cordset	4		PE930 Telephone Test Set w/ Adjustable Ringer	3
	Hard-wired P-Phone Adapter	4		PE940 Telephone Test Set w/ Amplified Speaker	3
	Hard-wired P-Phone Adapter with 5' Combi-cord	4		PE945 Telephone Test Set w/ Two-way Hands Free	3
	Hard-wired P-Phone Adapter with 5' OSP Cordset	4		PE950 Telephone Test Set w/ Amplified Speaker and DigAlert™ Lock-out	3
				PE961 Telephone Test Set w/ Two-way Hands Free and DigAlert	3
<b>PairMapper™ Twisted Pair Fault Tester</b>				Replacement Cordset for PE900 Series Telephone Test Sets	3
	Carrying Case for PairMapper Twisted Pair Fault Tester	8		Tele-Mate Communications Test Set	4
	Remote Terminators 2, 3, 4 for PairMapper Twisted Pair Fault Tester	8	<b>Tone and Probe Kits</b>		
	PairMapper Twisted Pair Fault Tester with Remote 1	8		A-Bug® Tone and Probe Kit	43
<b>Poly Line</b>		84		AdapToner Kit	41
<b>PROSCANNER™</b>				CATV Cable Tone Test Kit	42
	Carrying Case for PROSCANNER	8		Classic Tone and Probe Kit	41
	PROSCANNER Master Unit Only	8		LAN Toner Kit	42
	PROSCANNER Network Cable Test Kit	8		Premium Tone and Probe Kit	41
<b>Punchdown Tool</b>				Professional Tone and Probe Kit	41
	Punchdown Tool	62		Security and Alarm Kit	42
	Replacement Blades for Punchdown Tool	62	<b>Tone Generators</b>		
<b>Pulling Lubricant</b>				A-Bug Tone Sender	43
	Clear Lube™ Pulling Lubricant	84		A-Bug Tone Sender — Filtered	43
	Fiber-Gel™	83		AdapToner Modular Breakout Tone Generator	37
<b>Reference Cables</b>				Alarm Loop Verifier/Tone Generator	38
	Hybrid Reference Cables, FC-PC to Type-A, Multimode	33		Classic 77 Series Tone Generators	35
	Hybrid Reference Cables, FC-PC to Type-A, Single-mode	33		LAN Toner	37
	Standard Reference Cables, Type A to Type B, Multimode	33		Professional GX Series Tone Generators	36
	Standard Reference Cables, Type A to Type B, Single-mode	33		Replacement Piercing Clips for Tone Generators	36
<b>Strippers</b>				Tone Test Set	38
	Fiber Optic Buffer Stripper	70	<b>TurTEL Modular Adapters/Polarity Testers</b>		
	KWIK STRIPPER™ CATV Cable Stripper	61		TurTEL 6 Modular Adapter/Polarity Tester	5
	KWIK STRIPPER CATV/UTP Stripper	61		TurTEL 8 Modular Adapter	5
	KWIK STRIPPER Coax Stripper	60	<b>Voice Tagger Plus</b>		6
	KWIK STRIPPER Flat Telephone Cable Cutter/Stripper	59			
	KWIK STRIPPER Twisted Pair Stripper	60			





**Tempo**  
A Textron Company

Knowledge. Solutions. Success.

To contact us:  
toll free: 1.800.282.7941  
international: +1.815.397.4279  
fax: 1.815.397.1865  
[www.tempo.textron.com](http://www.tempo.textron.com)

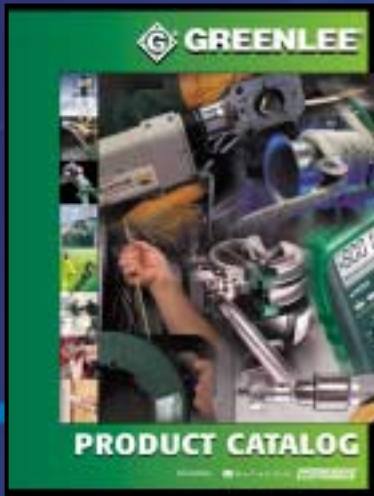

The full line of Greenlee products — everything for wire and cable installation from conduit bending to testing.



The toughest, most versatile, best performing selection of Greenlee test instruments ever.

### Need more information?

USA: Call: 1.800.435.0786 Fax: 1.800.451.2632

Canada: Call: 1.800.435.0786 Fax: 1.800.524.2853

International: Call: +1.815.397.7070 Fax: +1.815.397.9247

Or go online: [www.greenlee.textron.com](http://www.greenlee.textron.com)

# GREENLEE **TEXTRON**

To contact us:  
Greenlee Textron/Subsidiary of Textron Inc.  
4455 Boeing Drive, Rockford, IL 61109-2988 USA  
General offices: 815.397.7070