

FOT-930

MaxTester

NETWORK TESTING—OPTICAL

[EXFO FOT-932 Specs](#)

Provided by www.AAATesters.com



- FasTes™: three-wavelength measurement of optical loss, ORL and fiber length in 10 seconds
- All-in-one portable test solution: up to eight instruments combined in a single, eye-catching handheld package
- FTTx-ready: allows for the testing of passive optical networks (PONs) at 1310 nm, 1490 nm and 1550 nm, the three wavelengths recommended by the ITU-T (G.983.3) for PONs
- Cost of ownership: lowest in the industry, thanks to three-year warranty and recommended calibration interval, error-free testing and minimized training time



Next-Generation Network Assessment



EXPERTISE REACHING OUT

EXFO's Next-Generation MaxTester: Much More Features, Much Bigger Performance

The new FOT-930 MaxTester Multifunction Loss Tester is designed to help network service providers address CAPEX and OPEX issues, enable installers to easily adapt to all network types, and provide CATV operators with a single-unit solution to their backreflection, fiber-length, high-power and bidirectional loss measurement needs. Combined with its video fiber inspection probe, this unit also enables the easy detection of dirty or damaged connectors, providing a clear view of connectors and fiber ends on the FOT-930's high-resolution display.

All-in-one unit: combines up to eight instruments

- Loss meter
- Power meter
- Optical return loss (ORL) meter
- Visual fault locator
- Multimode and singlemode light sources
- Digital talk set
- Fiber-length meter
- Video fiber inspection probe

FasTest function*: one-touch, automated measurements in 10 seconds

- Bidirectional loss and ORL testing at up to three singlemode wavelengths
- Bidirectional loss testing at two multimode wavelengths
- Fiber-length measurement

Flexible solution: five-wavelength multimode and singlemode configurations meeting the requirements of installers/contractors for all test situations

- Up to three singlemode wavelengths—1310 nm, 1550 nm and a choice between 1490 nm and 1625 nm—on one port
- Two multimode wavelengths—850 nm and 1300 nm—on a second port

Future-proof: next-generation features meeting the latest industry requirements

- User-configurable pass/fail thresholds that can be adjusted to different industry standards
- FTTx-ready, allowing for the testing of passive optical networks (PONs) at 1310, 1490 and 1550 nm, the three ITU-T G.983.3 recommended wavelengths for PONs

Cost of ownership: lowest on the market

- Three-year warranty and recommended calibration interval
- Error-free testing achieved through visual loss and ORL pass/fail analysis
- Minimized training time, thanks to a single user interface for the eight instruments included in this all-in-one unit

Easy to use and ergonomic: built for today's fiber-optic test requirements

- Handy, eye-catching and rugged handheld package
- High-resolution color display
- Complete data management and report generation
- Nine hours power autonomy provided by field-swappable rechargeable batteries



With countless configurations available, the FOT-930 MaxTester is the handheld unit of choice for today's network service providers, fiber-optic network installers/contractors and CATV operators.

*Protected by US patent 5,455,672.

FTTx-Ready: Optimized for Testing Passive Optical Networks (PONs)

FTTx-Mode Operation

This mode lets you configure your FOT-930 MaxTester to suit your FTTx wavelengths and test-unit locations, as well as choose your preferred data presentation options for on-screen display or report generation. Key benefits include:

- Display of test data according to FTTx terminology
- Similar test-data presentation, regardless of the location of master and remote units

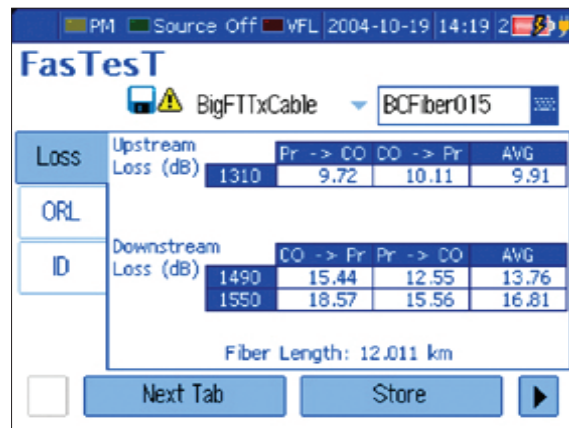

Integrated Data Storage Management

This feature enables the FasTesT initiator to save results on a remote unit—even when multiple remote units are used. Key benefits include:

- The possibility to store test data in a single unit
- Easier data post-processing and transfer from the FTB-3930 module (see figure below)

Point-to-Multipoint Testing with Multiple Referencing

Implemented in the FTB-3930 MultiTest Module, multiple referencing lets you coordinate the FTB-3930 with up to 10 remote FOT-930 MaxTester units. Key benefits include:

- First-class efficiency, as several technicians can simultaneously install and test distribution fibers

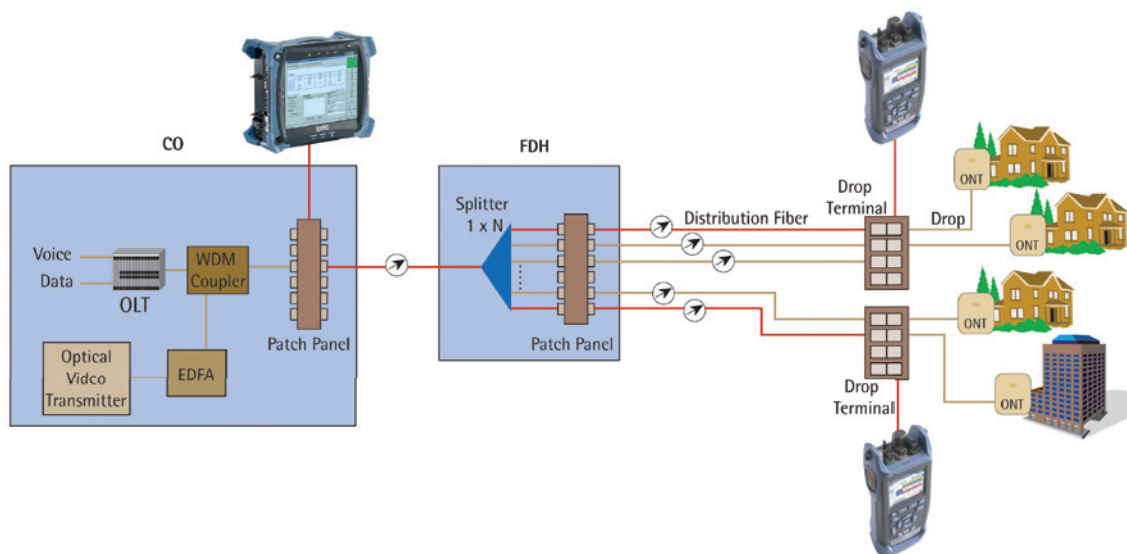

The FOT-930 allows for automated, bidirectional loss and ORL testing of passive optical networks (PONs) at 1310 nm, 1490 nm and 1550 nm, the three wavelengths recommended by the ITU-T (G.983.3) for PONs.

A Single Tool for All Backreflection, Fiber-Length and Loss Measurement Needs

Because learning how to operate only one instrument is easier and much faster, test specialists should choose an all-in-one tool that enables them to perform tasks such as installing long-haul high-speed networks, testing 1310/1490/1550 nm transmission in FTTH networks, performing multimode testing in enterprise networks, etc.—a do-it-all solution such as the FOT-930 MaxTester.

Key Advantages for All Network Types

- Fast, three-wavelength loss and ORL testing
- User-configurable pass/fail thresholds for error-free testing
- The only unit designed for testing both multimode and singlemode fiber
- Video fiber inspection probe, for easy viewing of connectors and fiber ends on the FOT-930's high-resolution display
- GeX detector, for high-power measurement up to +26 dBm
- Complete report generation capabilities
- Talk set and VFL options
- Ease of use, for faster testing, reduced training, minimum error potential, etc.

Loss	Loss (dB)			
	A->B	B->A	AVG	
ORL				
	1310	28.77	29.14	28.96
	1550	22.35	23.15	21.98
ID	1625	20.57	20.52	20.55
Fiber Length: 68.359 km				

In 10 seconds, the MaxTester's FasTest function provides insertion loss and ORL values for up to three wavelengths—including either 1490 or 1625 nm—on a single port.

Talk Set Port
For crystal-clear voice communication.

Power Meter Detector Port
Compatible with almost every connector on the market. Manually and efficiently perform power and loss testing. Accurately measure power up to +26 dBm.

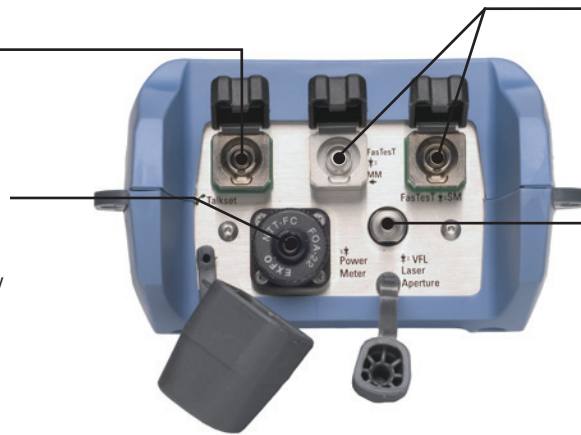

FasTesT Ports

Perform loss, ORL and fiber length measurements for up to three SM wavelengths on one port, and for two MM wavelengths on a second port.

VFL

Built-in 650 nm visual fault location on a universal connector.

Key Features

- Two FasTesT ports: a three-wavelength singlemode port, including either 1625 or 1490 nm, and a two-wavelength multimode port, for a total of up to five wavelengths
- Automatic measurement of ORL and fiber length during FasTesT
- Visual loss and ORL pass/fail analysis
- Large 320 x 240 color screen
- Storage of over 1000 complete test reports, with automated report generation
- Options: high-power detector, talk set, visual fault locator (VFL) and video fiber inspection probe
- No offset nulling required

FasTest Setup (As Master)		
FasTesT Port:	Singlemode	Loss Wavelengths
DUT Type:	125/9 μm	<input checked="" type="checkbox"/> 1310 nm
Compatibility:	FOT-930	<input checked="" type="checkbox"/> 1490 nm
Length Unit:	km	<input checked="" type="checkbox"/> 1550 nm
Auto save to:	Master unit	ORL Wavelengths
Mode/wave.:	Custom	<input checked="" type="checkbox"/> 1310 nm
		<input checked="" type="checkbox"/> 1490 nm
		<input checked="" type="checkbox"/> 1550 nm

While performing FasTesT measurements, the FOT-930 can launch automated loss and ORL measurements on all three wavelengths and perform fiber-length measurements.

Standard Data Reporting Features

The FOT-930's software automatically sets up test data in an easy-to-read, well-organized table. Testing is simplified thanks to the highly intuitive user interface and integrated test functions, taking software user-friendliness to the next level.

- Select predefined test parameters and pass/fail thresholds
- Customize user settings and cable identification parameters
- Add operator comments
- Generate reports for ORL, bidirectional loss (three wavelengths) and fiber length measurement

Report Generation

Growing fiber deployment in NSP and CATV networks sometimes leads installation companies to hire subcontractors. These subcontractors must produce proper test documentation to corroborate the tests were performed as specified.

EXFO's FOT-930 MaxTester easily and efficiently provides complete, high-quality test documentation. Its data logging and management features help users quickly access and download test results to any PC through the RS-232 port for in-depth analysis and first-class report generation.

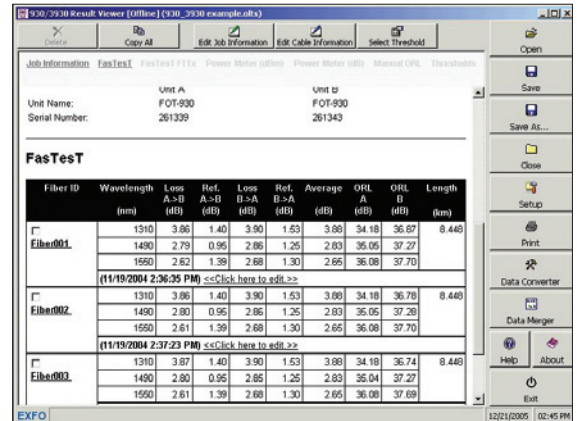

Display comprehensive test results thanks to Optical Report Viewer software.

Fiber ID	Wavelength	Loss A->B	Loss B->A	Mean	Orl A	Orl B	Length
FIBER001	1310	-3.35	-3.22	-3.28	-30.86	-33.24	8415
	1550	-2.05	-1.72	-1.88			
	1625	-2.15	-1.88	-2.01	-33.05	-34.82	
FiberComment							
FIBER002	1310	-3.27	-3.18	-3.27	-30.94	-33.64	8415
	1550	-2.29	-1.94	-2.11			
	1625	-2.62	-2.25	-2.43	-33.35	-35.48	
FiberComment							
FIBER003	1310	-3.38	-3.25	-3.28	-30.84	-33.17	8415
	1550	-2.09	-1.75	-1.92			
	1625	-2.19	-1.86	-2.02	-33.11	-34.87	
FiberComment							
FIBER004	1310	-3.36	-3.18	-3.27	-30.94	-33.43	8415
	1550	-2.10	-1.77	-1.93			
	1625	-2.17	-1.85	-2.01	-33.09	-34.85	
FiberComment							
FIBER002	1310	-3.36	-3.18	-3.27	-31.04	-33.77	8415
	1550	-2.48	-2.28	-2.38			
	1625	-2.85	-2.72	-2.79	-33.79	-36.72	
FiberComment							
FIBER003	1310	-3.59	-3.37	-3.48	-30.96	-33.20	8415
	1550		-2.43	-2.17			
	1625	-3.38	-3.03	-3.19	-37.12	-31.68	
FiberComment							
FIBER004	1310	-3.81	-3.68	-3.74	-30.80	-33.27	8414
	1550	-2.42	-2.07	-2.24			
	1625	-3.64	-3.35	-3.49	-30.31	-34.33	
FiberComment							
FIBER005	1310	-3.81	-3.67	-3.74	-30.42	-33.79	8417
	1550	-2.42	-2.07	-2.24			
	1625	-3.64	-3.35	-3.49	-30.33	-34.34	
FiberComment							

The FOT-930 quickly provides you with full FasTest reports.

Online Help Menu and Multilingual Interface, for Enhanced User-Friendliness

The FOT-930 MaxTester features a comprehensive, easy-to-use on-line help menu providing all the necessary information required for highly efficient instrument operation—an advantage offered by no other test unit on the market. This feature contributes to the FOT-930's unequalled user-friendliness.

The FOT-930's interface is available in seven languages: English, Simplified Chinese, Spanish, French, German, Czech and Russian. This allows users to choose their preferred language, further reduce training and testing time.

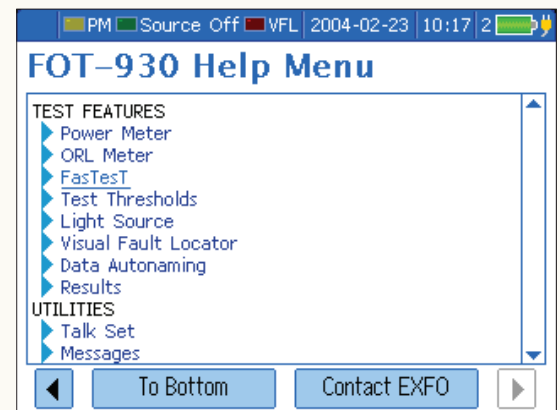

The online help menu and choice of interface language significantly increase user efficiency.

Fast-Track Data Post-Processing with FastReporter Software

FastReporter includes a powerful tool that **automates repetitive operations on large numbers of OTDR test files**. You can process an unlimited number of files in a session, and combine single operations into multi-operation batch sessions. In a nutshell, FastReporter optimizes your productivity.

Batch documentation

- Document an entire cable/project in a matter of seconds
- Save time in the field by documenting your files at the office
- Manage different measurements simultaneously

Get uniformity in your results

- Adjust cable and fiber parameters
- Set detection thresholds for all measurements at once

Batch analysis

- Adjust parameters for all cables at once
- Adjust detection thresholds
- Set pass/fail thresholds for OTDR, OLTS, CD and PMD testing and characterize your link. Make sure you meet the link's requirements.

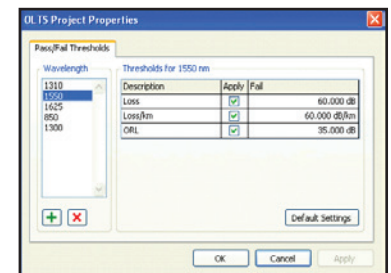
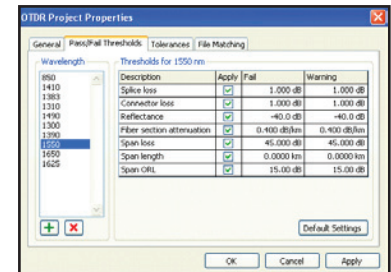

Flexible reporting

Various report templates to choose from

- ✓ Loss and ORL (including EXFO's FasTesT function)
- ✓ OTDR
- ✓ PMD
- ✓ Chromatic dispersion (CD)
- ✓ Fiber characterization
- ✓ Cable report

General Information														
Cable ID:		Cable 012		Customer:		Telcom Company		Company:		EXFO				
Fiber Characterization														
Fiber ID	CD @ 1550 nm (ps/nm)	Coef.	Delay (ps)	Coef.	Wave length (nm)	OLTS				OTDR				
						Average Loss (dB)	OL A-B (dB)	OL B-A (dB)	Length (km)	Length (km)	Max Splice (dB)	Avg Splice (dB)		
G2	2333.94	18.84	0.50	0.04	1550	27.620	27.710	27.820	31.78	32.19	138.5860	138.6335	0.198	0.027
					1625	29.600	29.400	29.540	32.35	33.41	138.5860	138.6306	0.212	0.041
G1	2241.23	18.89	0.34	0.03	1550	28.730	28.600	28.880	32.05	32.82	138.5460	138.5876	0.348	0.087
					1625	30.280	30.280	30.310	32.58	34.15	138.5460	138.5840	0.229	0.050
G4	2237.21	18.79	0.44	0.04	1550	29.010	28.870	28.940	32.87	32.80	138.5370	138.5825	0.217	0.078
					1625	30.070	30.040	30.030	33.53	34.05	138.5370	138.5804	0.198	0.078
G3	2228.98	18.81	0.61	0.05	1550	28.090	27.940	28.010	31.80	32.38	138.5370	138.5837	0.214	0.068
					1625	29.790	29.740	29.760	32.25	33.61	138.5370	138.5847	0.228	0.084

OTDR Cable Report												
Event ID	1 Launch Loss @ 1550 nm		2 Reflection Peak @ 1550 nm		3 Non-Reflective Peak @ 1550 nm		4 Non-Reflective Peak @ 1550 nm		5 Reflection Peak @ 1550 nm		6 Reflection Peak @ 1550 nm	
	Loss (dB)	Start (km)	Loss (dB)	Start (km)	Loss (dB)	Start (km)	Loss (dB)	Start (km)	Loss (dB)	Start (km)	Loss (dB)	Start (km)
Fiber#1 (1550 nm)	-42.7	0.271	-44.2	0.211	-0.222	-0.229	-48.4					
Fiber#2 (1550 nm)	-47.2	0.208	-41.4	0.112	-0.047	0.109	-35.1					
Fiber#3 (1550 nm)	-47.1	0.345	-43.6	0.211	-0.205	-0.205	-24.4					
Fiber#4 (1550 nm)	-49.8	0.208	-43.8	0.205	-0.027	0.204	-48.8					
Fiber#5 (1550 nm)	-47.1	0.210	-45.0	0.212	-0.217	0.263	-43.8					
Fiber#6 (1550 nm)	-42.8	0.208	-44.4	0.109	-0.054	0.101	-45.1					
Fiber#7 (1550 nm)	-47.2	0.403	-43.9	0.104	-0.024	0.118	-48.0					
Fiber#8 (1550 nm)	-49.0	0.276	-42.0	0.240	-0.020	-0.017	-48.7					
Fiber#9 (1550 nm)	-47.1	0.202	-45.0	0.207	-0.036	0.020	-45.6					
Fiber#10 (1550 nm)	-45.1	0.168	-42.0	0.148	-0.002	0.104	-38.7					
Max	-42.7	0.205	-43.0	0.148	-0.002	0.110	-35.1					

OTDR cable report.

Fiber characterization report.

One cable report replaces hundreds of single-fiber test printouts, simplifying and speeding up high-fiber-count data management. This report automatically provides per-event and per-fiber statistics and flags threshold-exceeding values. It also generates end-to-end reports for one or many wavelengths.

Report customization

Create your own report template with external reporting software such as Crystal Reports®.

Format saving

Easily create comprehensive **PDF**, **Excel** or **HTML** reports, with no additional formatting.

Copy Graph function

Customize your reports by integrating your graphs into documents such as Excel, Word, etc.

For more details on FastReporter, visit the FastReporter product page on EXFO's website.

Specifications ^a

EXTERNAL POWER METER

	FOT-932	FOT-932X	FOT-933
Detector type	Ge	GeX	InGaAs
Measurement range (dBm)	10 to -70	26 to -55	6 to -73
Range displayed (dBm)	Down to -77	Down to -65	Down to -80
Uncertainty ^{b, c}	± 5 % ± 0.1 nW	± 5 % ± 3 nW	± 5 % ± 0.05 nW
Wavelength range (nm)	800 to 1650	800 to 1650	800 to 1650
Display resolution (dB) ^b	0.01	0.01	0.01
Calibrated wavelengths	40	42	40
Recommended recalibration period (years)	3	3	3
Automatic offset nulling ^d	Yes	Yes	Yes
Measurement-distance units	kilometers, meters, kilofeet, feet, miles		

SOURCES

	Standard	-4	-5	-12C (second port)	-12D (second port)
Wavelengths (nm) ^e	1310 ± 20 1550 ± 20	1310 ± 20 1550 ± 20 1625 ± 10	1310 ± 20 1490 ± 10 1550 ± 20	850 ± 25 1300 +50/-10	850 ± 25 1300 +50/-10
Emitter type	Laser	Laser	Laser	LED	LED
Minimum output power (dBm) ^e	-1/-1	-1/-4/-7	-1/-7/-4	-27/-27 (50/125 μm) ^l	-21/-21 (62.5/125 μm) ^l
Spectral width (nm) ^f	≤ 5/≤ 5	≤ 5/≤ 5/≤ 5	≤ 5/≤ 5/≤ 5	50/135	50/135
Stability (8 hours) (dB) ^g	± 0.05	± 0.05	± 0.05	± 0.05	± 0.05

FASTEST

	Standard	-4	-5	-12C (second port)	-12D (second port)
Wavelengths (nm)	1310 1550	1310 1550 1625	1310 1490 1550	850 1300	850 1300
Loss range (dB) ^h	60	56	56	40	46
Loss precision (repeatability) (dB) ⁱ					
side-by-side	0.15	0.15	0.15	0.15	0.15
loopback	0.25	0.25	0.25	0.25	0.25
Length measurement range (km)	200	200	200	5	5
Length measurement uncertainty ^j	±(10 m + 1 % x length)				

DEDICATED ORL

	All SM Wavelengths
ORL range (APC / UPC) (dB)	65/55
ORL uncertainty (dB) ^k	± 0.5
Resolution (dB) ^b	0.01

TALK SET

Emitter type	Laser
Wavelength (nm)	1550 ± 20
Dynamic range at 1550 nm (dB)	45
Dynamic range MM (dB) ^l	40

VFL ⁱ

Emitter type	Laser
Wavelength (nm)	650
Output power (dBm)	3

GENERAL SPECIFICATIONS

Size (H x W x D)	250 mm x 125 mm x 75 mm	(9 7/8 in x 4 15/16 in x 3 in)
Weight	1 kg	(2.2 lb)
Temperature	operating -10 °C to 50 °C storage ^m -40 °C to 70 °C	(14 °F to 122 °F) (-40 °F to 158 °F)
Storage	Capacity of 1024 complete tests	
Relative humidity	0 % to 95 % non-condensing	
Power ⁱ	Li-Ion battery (9 hours) 3 hours to fully recharge when unit is off	
Warranty (years)	3	

STANDARD ACCESSORIES

User guide, AC adapter/charger, 2 Li-Ion batteries, shoulder strap, Certificate of Calibration.

Notes

- At 23 °C ± 1 °C and 1550 nm with FC connector and on batteries, unless otherwise specified.
- Resolution, uncertainty and linearity are functions of input power; uncertainty is valid at calibration conditions.
- Up to 20 dBm for GeX.
- Power of > -45 dBm for Ge, > -30 dBm for GeX and > -47 dBm for InGaAs.
- In High source mode.
- As defined by Telcordia TR-TSY-000887, rms for lasers and at -3 dB for LEDs; typical values for LEDs.
- After a warm-up time of 6 minutes, in CW source mode.
- Typical value, at 1550 nm for SM and 850 nm for MM.
- Typical value.
- For fiber length ≤ 120 km.
- Typical value.
- For graded-index MM fibers, typical.
- Without batteries.

ORDERING INFORMATION

FOT-93X-XX-XX-XX

Model ■

FOT-932 = Ge detector, dual-wavelength 1310/1550 nm
 FOT-932-4 = Ge detector, triple-wavelength 1310/1550/1625 nm
 FOT-932-5 = Ge detector, triple-wavelength 1310/1490/1550 nm
 FOT-932X = GeX detector, dual-wavelength 1310/1550 nm
 FOT-932X-4 = GeX detector, triple-wavelength 1310/1550/1625 nm
 FOT-932X-5 = GeX detector, triple-wavelength 1310/1490/1550 nm
 FOT-933 = InGaAs detector, dual-wavelength 1310/1550 nm
 FOT-933-4 = InGaAs detector, triple-wavelength 1310/1550/1625 nm
 FOT-933-5 = InGaAs detector, triple-wavelength 1310/1490/1550 nm
 FOT-932-12C = Ge detector, dual-wavelength 1310/1550 nm (first port),
 dual-wavelength 850/1300 nm LED (50/125 μm) (second port)
 FOT-932-12D = Ge detector, dual-wavelength 1310/1550 nm (first port),
 dual-wavelength 850/1300 nm LED (62.5/125 μm) (second port)
 FOT-932X-12C = GeX detector, dual-wavelength 1310/1550 nm (first port),
 dual-wavelength 850/1300 nm LED (50/125 μm) (second port)
 FOT-932X-12D = Ge detector, dual-wavelength 1310/1550 nm (first port),
 dual-wavelength 850/1300 nm LED (62.5/125 μm) (second port)

Talk set and visual fault locator ^a ■

00 = Without talk set and VFL
 VFL = With visual fault locator
 VFT = With talk set and VFL (universal 2.5 mm connector)

Connector* ■

EI-EUI-28 = UPC/DIN 47256
 EI-EUI-76 = UPC/HMS-10/AG
 EI-EUI-89 = UPC/FC narrow key
 EI-EUI-90 = UPC/ST
 EI-EUI-91 = UPC/SC
 EI-EUI-95 = UPC/E-2000
 EA-EUI-28 = APC/DIN 47256 ^b
 EA-EUI-89 = APC/FC narrow key ^b
 EA-EUI-91 = APC/SC ^b
 EA-EUI-95 = APC/E-2000 ^b

Probe option ■

00 = Without probe
 FP4S = Inspection probe (400x)
 FP4D = Inspection probe (200x/400x)

*EXFO Universal Interface is protected by US patent 6,612,750.

Example: FOT-932X-4-VFL-FP4S-EI-EUI-89

Notes

- Connector type for the talk set is the same as the one specified for the main source.
- Not available with second source.

SAFETY

21 CFR 1040.10 and IEC 60825-1:2007

Emitters used for sources, FasTesT, ORL and talk set

CLASS 1 LASER PRODUCT

The FOT-930's optional VFL is a Class 3R laser product. Output power level is lower than the maximum specified on label.

Refer to specifications for output power.

⚠ If VFL option is available



EXFO Corporate Headquarters > 400 Godin Avenue, Quebec City (Quebec) G1M 2K2 CANADA | Tel.: +1 418 683-0211 | Fax: +1 418 683-2170 | info@EXFO.com

Toll-free: +1 800 663-3936 (USA and Canada) | www.EXFO.com

EXFO America	3701 Plano Parkway, Suite 160	Plano, TX 75075 USA	Tel.: +1 800 663-3936	Fax: +1 972 836-0164
EXFO Asia	100 Beach Road, #22-01/03 Shaw Tower	SINGAPORE 189702	Tel.: +65 6333 8241	Fax: +65 6333 8242
EXFO China	36 North, 3 rd Ring Road East, Dongcheng District Room 1207, Tower C, Global Trade Center	Beijing 100013 P. R. CHINA	Tel.: + 86 10 5825 7755	Fax: +86 10 5825 7722
EXFO Europe	Omega Enterprise Park, Electron Way	Chandlers Ford, Hampshire S053 4SE ENGLAND	Tel.: +44 2380 246810	Fax: +44 2380 246801
EXFO NetHawk	Elektroniikkatie 2	FI-90590 Oulu, FINLAND	Tel.: +358 (0)403 010 300	Fax: +358 (0)8 564 5203
EXFO Service Assurance	270 Billerica Road	Chelmsford, MA 01824 USA	Tel.: +1 978 367-5600	Fax: +1 978 367-5700

EXFO is certified ISO 9001 and attests to the quality of these products. This device complies with Part 15 of the FCC Rules. Operation is subject to the following two conditions: (1) this device may not cause harmful interference, and (2) this device must accept any interference received, including interference that may cause undesired operation. EXFO has made every effort to ensure that the information contained in this specification sheet is accurate. However, we accept no responsibility for any errors or omissions, and we reserve the right to modify design, characteristics and products at any time without obligation. Units of measurement in this document conform to SI standards and practices. In addition, all of EXFO's manufactured products are compliant with the European Union's WEEE directive. For more information, please visit www.EXFO.com/recycle. Contact EXFO for prices and availability or to obtain the phone number of your local EXFO distributor.

For the most recent version of this spec sheet, please go to the EXFO website at www.EXFO.com/specs.

In case of discrepancy, the Web version takes precedence over any printed literature.