

OTDR Module Series

FTB-7000B/FTB-7000C



Triple-wavelength capability in one module

New-generation singlemode and multimode OTDR modules

High-speed traces starting at 10 seconds

Sampling resolution down to 8 cm

Compatible with the FTB Universal Test System and FTB-100B Mini-OTDR

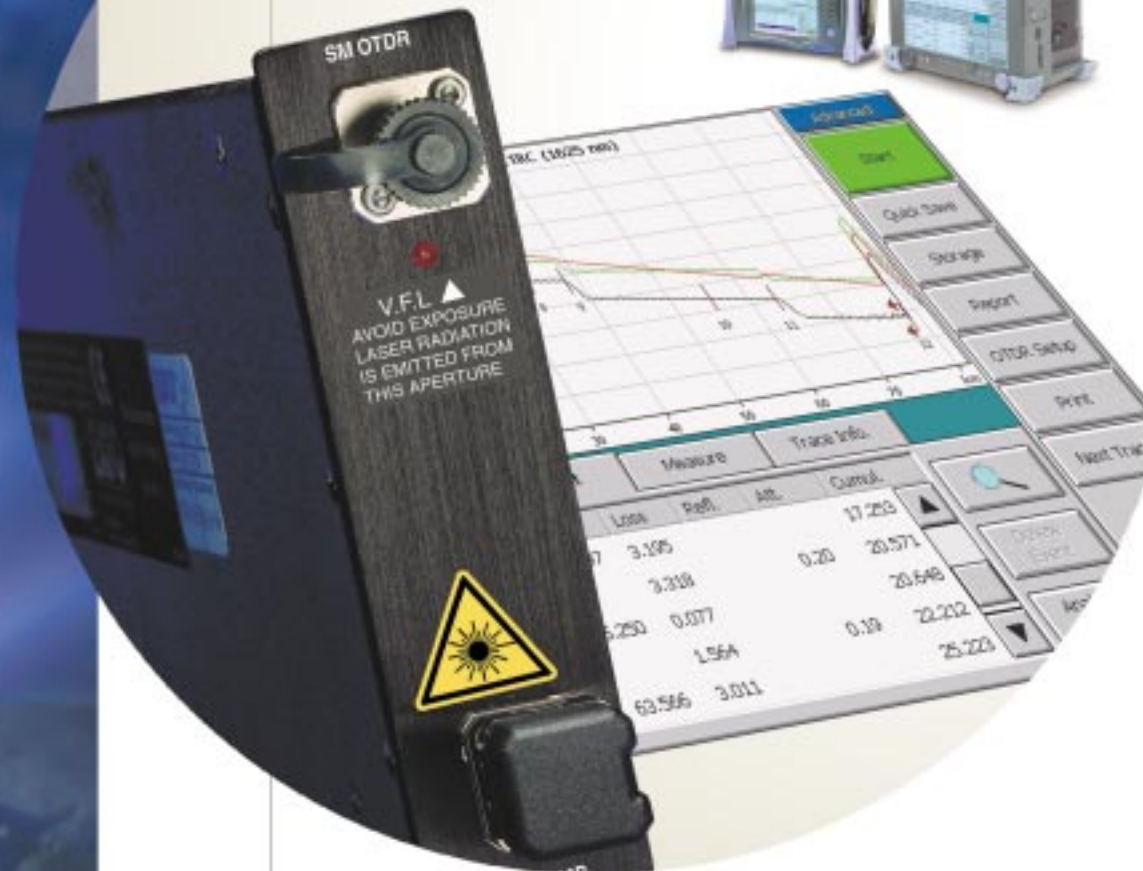

Fiber-optic test,
measurement, monitoring
and automation solutions



Big OTDR Choice. Big Hardware Performance.

In today's competitive market, high-performance, easy-to-use OTDRs are more essential than ever for installing, maintaining and troubleshooting networks. With the new FTB-7000B and FTB-70000C series OTDR modules from EXFO, you get the right tools to precisely detect and analyze fiber splices, connectors, breaks and other events along a fiber link. The FTB-7000B series delivers a wide choice of OTDRs to conveniently test the range of optical networks out there. What's more, the FTB-74234C makes multiple wavelength testing faster than ever by combining 3-wavelength capability in the same module.

Technicians can select from over 20 modules in this OTDR series. Choose from dynamic ranges that cover shorter distances in LAN/WAN and metro applications longer distances in long-haul networks. You can easily characterize links exceeding 200 km with the 45 dB OTDR module—ideal for submarine links. Meet all your testing needs with the complete range of singlemode and multimode configurations available at several wavelengths. Most important, OTDR modules are field-interchangeable and easily inserted into any of EXFO's rugged, portable test platforms, including the new, powerful FTB-400.

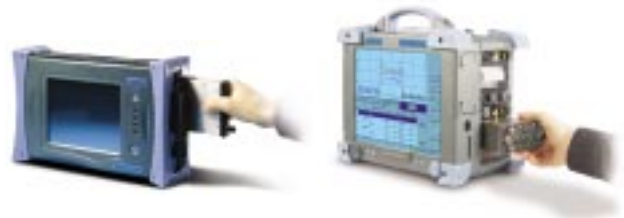

OTDR modules fit smoothly into EXFO's platforms durable test.

Key Features

All FTB-7000B and FTB-70000C OTDRs come with these built right in features:

- Reduced trace noise: catch low-loss events.
- Short dead zones: detect closely spaced events.
- Four-point loss measurements: measure event loss and reflectance accurately.
- Optical return loss (ORL) calculation: pinpoint the backreflection level of singlemode networks, components and connectors.
- Quick startup: reach 90% of maximum dynamic range in under 30 seconds.
- Fast acquisition, fast analysis: a trace starting at 7 seconds.
- High sampling counts: locate events with unparalleled precision.
- Down to 8 cm sampling resolution: pinpoint fault locations with extreme accuracy.

Get the Right Fit

- module choices for testing flexibility
- singlemode modules at 1310 nm, 1410 nm, 1550 nm and 1625 nm
- Triple wavelength module
- multimode modules at 850 nm and 1300 nm
- dynamic range up to 45 dB
- EXFO Universal Interface (EUI) connector: UPC- and APC-compatible 
- Visual Fault Locator (VFL) option ideal for troubleshooting in LAN/WAN and metro networks

Advanced Network Solutions

High-fiber-count cables and DWDM technology are creating new challenges that must be met head-on by today's fiber-optic professionals. Among these, test and measurement speed has been critical to technicians working in the field. EXFO hardware can help you handle today's demanding test operations.

High Fiber Counts

Speed up ribbon fiber cable installation with the FTB-9100 Optical Switch Module. Combine this module with an FTB-7000B OTDR or an FTB-7000C for efficient batch fiber testing of patch panels or bare-ribbon testing during installation. Test up to 12 fibers consecutively, saving valuable reconnecting time. Choose from two output connector types: MTP (ribbon) or SC. With just a single connector to insert, MTP patchcords reduce test setup time and connect ribbon fiber directly to the OTDR—an industry first. Switch modules are available for singlemode and multimode fibers.

EXFO provides complete OTDR testing kits including multifiber, ribbonized and bare ribbon configurations. To learn more, ask for specification sheets for the FTB-9100 Optical Switch Module and EXFO's Ribbon Fiber Test Kits.



FTB-9100 Optical Switch Module, MTP configuration, SC configuration.

New Transmission Windows

DWDM systems are pushing transmission beyond conventional windows. Installers need OTDRs that can keep up. Qualify systems for L-band transmission with the 1625 nm module; qualify systems that use new fiber without water-peak attenuation with the 1410 nm module.

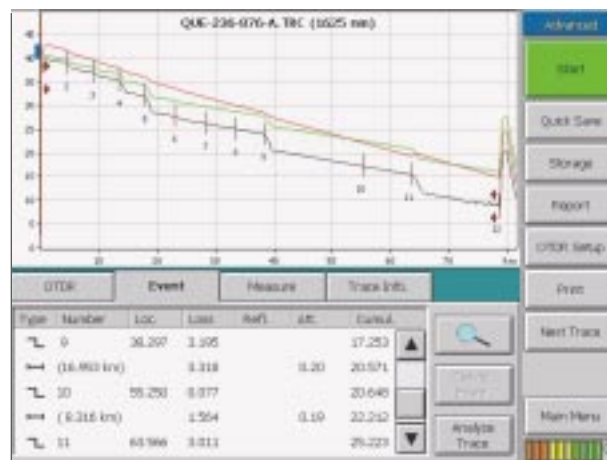

End-to-end trace and data tables

High-Speed, High-Quality Traces

When characterizing fiber links, choose the depth of analysis that suits your project: end-to-end trace or bidirectional trace.

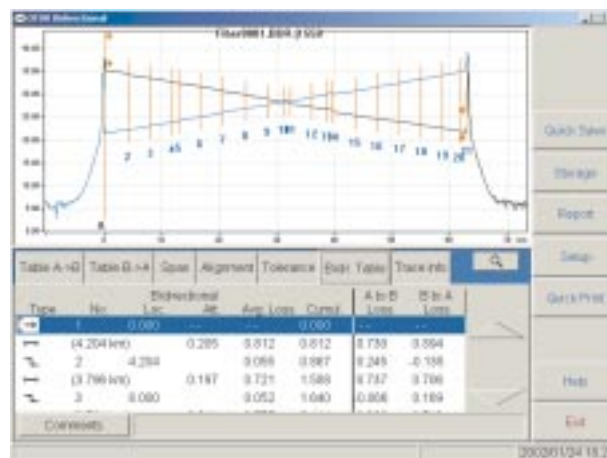

Bidirectional trace and data tables

Software That Boosts Productivity

Each FTB-7000B and FTB-7000C module comes with the exclusive EXFO ToolBox OTDR software. Streamline data acquisition in the field and report generation back at the office with this powerful program. Choose from two testing approaches: Auto Mode and Advanced Mode.

Auto Mode: One-Button Testing

Ideal for basic, repetitive applications, Auto Mode shortens the learning curve for new OTDR users.

- preset test parameters
- choice of single- or dual-wavelength OTDR testing
- convenient one-step event table

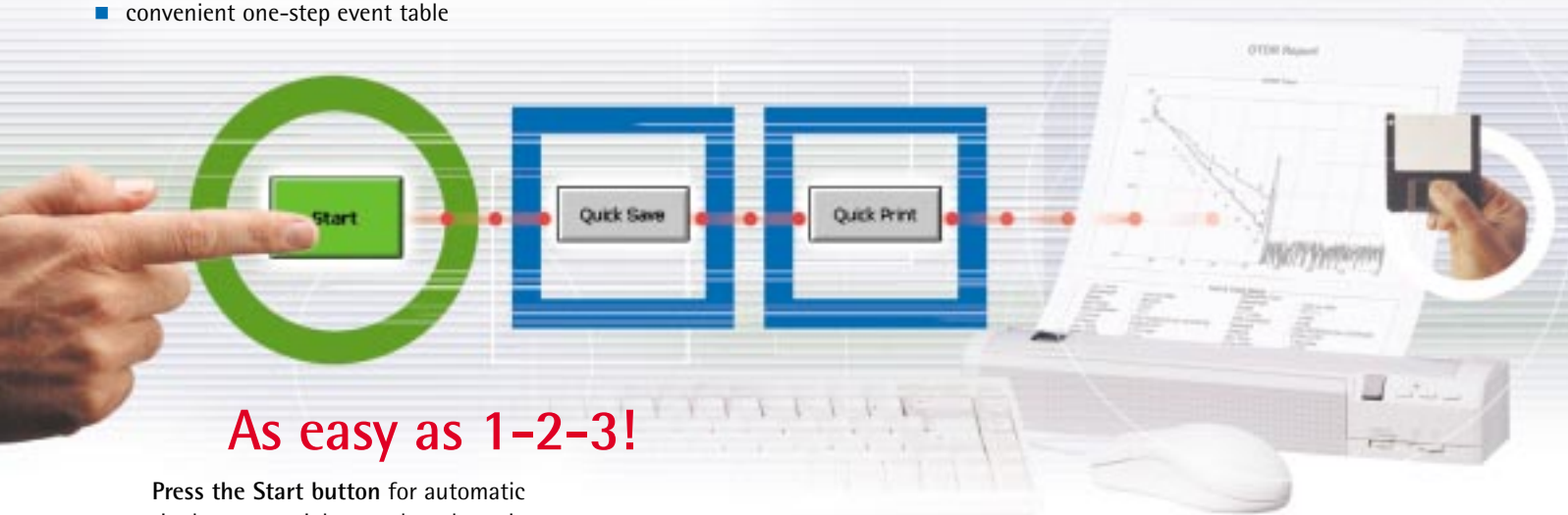

As easy as 1-2-3!

Press the **Start** button for automatic single- up to triple-wavelength testing to compile complete OTDR test results.

Quick Save with automated trace-naming completes the test routine.

Quick Print produces a detailed test report.

Benefits at a Glance

- Seven key cable acceptance criteria at a glance. Tailor the Pass/Warning/Fail thresholds for ribbon and multifiber validation to your specifications.
- Smooth data management: file autonaming utility with subset cable and fiber incrementation.



Advanced Mode: Flexibility for Experts

For complete control of your test routine select Advanced Mode. Manually set all acquisition parameters, including the index of refraction (IOR) and helix factor. Save time and get better results by fine-tuning acquisition parameters on the fly.

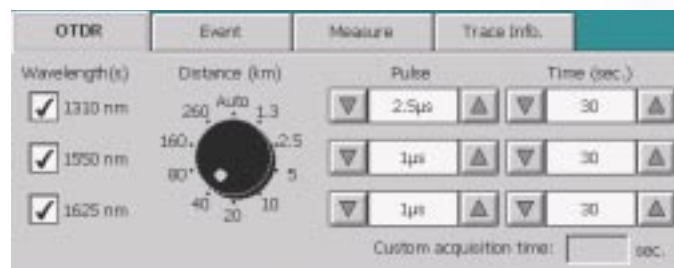

Time Savers from Toolbox OTDR Software

Template Trace Mode

Compare new traces with a designated reference on the fly. Reference trace documentation is automatically pasted into new acquisitions. Ideal for multifiber testing, the Template Trace Mode also allows easy modification of the reference trace.

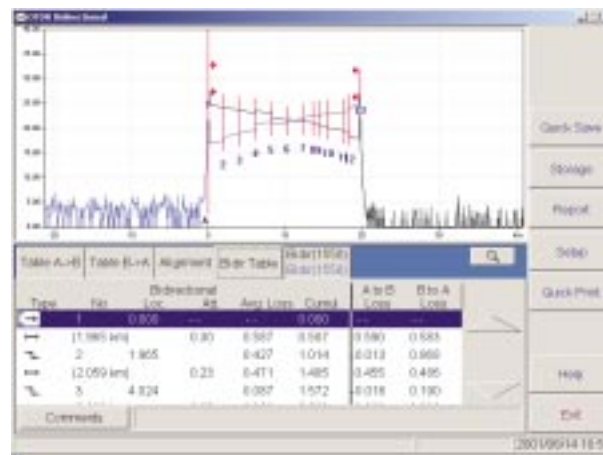

Bidirectional Analysis

Take acquisitions from both fiber ends to obtain loss averages for each fiber event. Obtain essential data for today's tighter loss budgets.

- Cut unnecessary retesting: the first connection check displays a warning in case of a poor OTDR connection.
- Create separate setup files and password access for multiple users.
- Adjust preferences for trace display and printout for easy viewing.



Integrated Switch Application

Programs custom test routines. Use the results table to rapidly check acceptance.

Fast-Track Your Cable Reports

Accelerate OTDR data post-processing with specialized ToolBox Office Pro software. For high-fiber-count projects, two key ToolBox 6 utilities—the batch processor and cable report generator—can cut OTDR post-processing time by up to 90 %. Install ToolBox Office Pro software on your office PC for convenient data post-processing.

Create complete cable reports easily. Replace hundreds of single-fiber test printouts with a single report, making data management on high-fiber-count projects easier and faster. Obtain statistics automatically, per event and per fiber. Generate average and maximum values for all the fibers of a cable or for a test session. Print reports with end-to-end or bidirectional OTDR data based on single or multiple wavelengths and include results on event reflectance, ORL and macrobends with this powerful utility.

User-Centric Print Options

■ Cable Report Function

Create cable acceptance reports and get down to specifics with:

1. **Fiber Event Report**
Complete event data in a compact format
2. **Fiber Section Report**
Get a close-up look at any fiber section
3. **Fault Report**
Faults feedback based on specified user-thresholds.



Fiber Event Report

Fiber Section Report

Fault Report

■ Batch Print Function

Choose from three print modes: Normal (full-size, multi-page OTDR report), Compressed (one-page report), or Multi-Trace (4, 6, or 8 traces per page). Plus, add report statistics such as event tables.

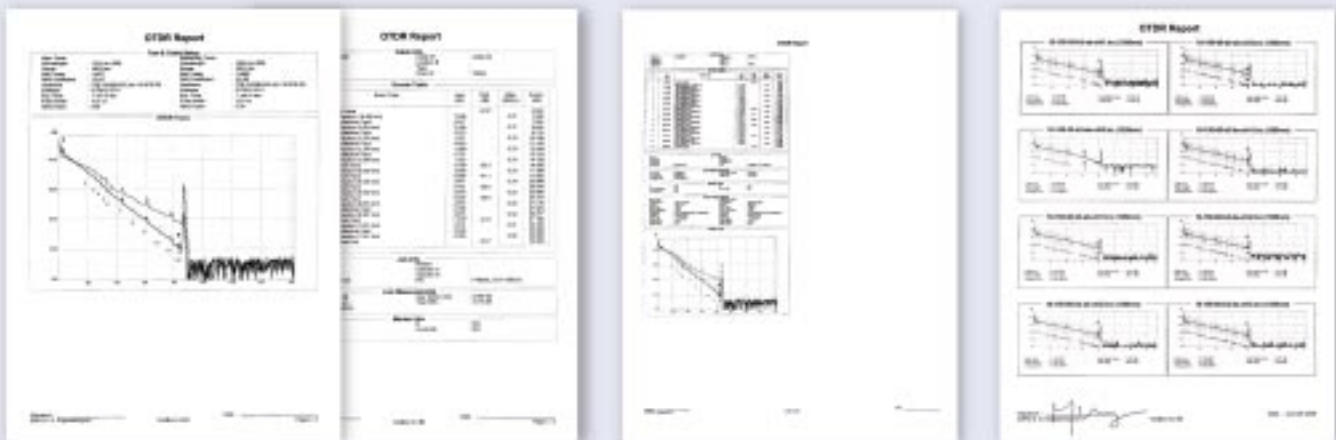

Normal

Compressed

Multi-Trace

■ Quick-Print Function

Print the on-screen OTDR trace and choose statistics.

Specifications

OTDR Multimode Module Specifications¹

| Wavelength (nm) | Dynamic range ² (dB) at 100 ns/1 μs | Event dead zone ³ (m) | Attenuation dead zone ³ (m) | Model |
|--------------------|--|----------------------------------|--|--------------------------------|
| 850 ± 20/1300 ± 20 | 23/27 (C), 25/29 (D) | 1.5/1.5 | 5/5 | FTB-7212B- C or D ⁷ |

OTDR Singlemode Module Specifications¹

| Wavelength (nm) | Dynamic range ² (dB) at 10 μs | Dynamic range ² (dB) at 20 μs | Event dead zone ⁵ (m) | Attenuation dead zone ⁵ (m) | Model |
|--------------------------------------|--|--|----------------------------------|--|--------------------------|
| Single-Dual-Wavelength module | | | | | |
| 1310 ± 20/1550 ± 20 | 32/31 | - | 3/3 | 10/15 | FTB-7223B-B ⁷ |
| 1310 ± 20/1550 ± 20 | 37.5/35.5 | 38.5/37.5 | 3/3 | 10/15 | FTB-7323B-B |
| 1310 ± 20/1550 ± 20 | 40/38 | 41.5/39.5 | 3/3 | 10/15 | FTB-7423B-B |
| 1310 ± 20/1550 ± 20 | 43.5/41.5 ⁴ | 45/43 ⁴ | 3/3 | 10/15 | FTB-7523B-B |
| 1410 ± 10 | 37 | 38.5 | 3 | 10 | FTB-7405B-B |
| 1550 ± 20 | 42 | 45 ⁴ | 3 | 15 | FTB-7503B-B-ER |
| 1625 ± 10 | 35 | 36 | 3 | 16 | FTB-7304B-B |
| 1625 ± 10 | 38 | 39 | 3 | 16 | FTB-7404B-B |
| 1625 ± 10 | 40 | 41.5 | 3 | 16 | FTB-7504B-B |
| 1550 ± 20/1625 ± 10 | 35.5/35 | 37.5/36 | 3/3 | 15/16 | FTB-7334B-B |
| 1550 ± 20/1625 ± 10 | 40/38 | 40.5/39 | 3/3 | 15/16 | FTB-7434B-B |
| 1550 ± 20/1625 ± 10 | 42/40 | 43.5/41.5 | 3/3 | 15/16 | FTB-7534B-B |
| Triple-Wavelength module | | | | | |
| 1310 ± 20/1550 ± 20/1625 ± 10 | 41/39/38 | 42.5/40.5/39.5 | 3/3/3 | 8/10/10 | FTB-74234C-B |

Other OTDR configurations are available. Contact your EXFO representative for more information.

General Specifications

| Models | 200B-C/D series | 200B-B series | 300B-B/400B-B/ 500B-B/4234C-B series |
|---|--|--|--|
| Distance range (km) | 0.625, 1.25, 2.5, 5, 10, 20, 40 | 1.25, 2.5, 5, 10, 20, 40, 80, 160 | 1.25, 2.5, 5, 10, 20, 40, 80, 160, 260 |
| Pulse width (ns) | 10, 30, 100 (850 nm) 10, 30, 100, 275, 1000 (1300 nm) | 10, 30, 100, 275, 1000, 10 000 | 10, 30, 100, 275, 1000, 2500, 10 000, 20 000 |
| Linearity ⁸ (dB/dB) | ± 0.05 | ± 0.05 | ± 0.05 |
| Loss threshold (dB) | 0.01 | 0.01 | 0.01 |
| Loss resolution (dB) | 0.001 | 0.001 | 0.001 |
| Sampling resolution (m) | 0.08 to 5 | 0.08 to 5 | 0.08 to 5 |
| Sampling points | Up to 16 000 | Up to 32 000 | Up to 52 000 |
| Distance uncertainty ⁶ | ± (1 m + 0.0025 % x distance) | ± (1 m + 0.0025 % x distance) | ± (1 m + 0.0025 % x distance) |
| Measurement time | User-defined (60 min maximum) | User-defined (60 min maximum) | User-defined (60 min maximum) |
| Real-time refresh | < 1 s | < 1 s | < 1 s |
| Stable source output power ⁹ (dBm) | -7 | -10 | -5 |
| Visual fault locator (optional) | Laser, 650 ± 10 nm CW, P _{out} maximum: 800 μW | Laser, 650 ± 10 nm CW, P _{out} maximum: 800 μW | Laser, 650 ± 10 nm CW, P _{out} maximum: 800 μW |

Notes

- All specifications are for a temperature of 23 °C (73 °F) with a FC/PC connector unless otherwise specified.
- Typical dynamic range with a three-minute average at SNR = 1.
- Typical dead zone of multimode modules for reflectance below -35 dB, using a 10 ns pulse.

- Typical dynamic range on NZDSF with a three-minute average at SNR = 1.
- Typical dead zone of singlemode modules for reflectance below -45 dB, using a 10 ns pulse.
- Does not include uncertainties due to fiber index and sampling resolution.
- ORL measurement not available for this module.
- Does not include uncertainty due to sampling resolution.
- Typical output power value.

Safety

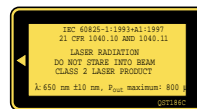
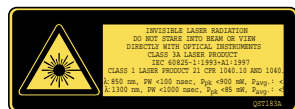
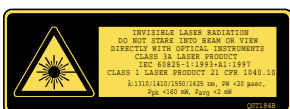

LASER SAFETY

21 CFR 1040.10

IEC 60825-1:Ed.1:1998

CLASS 1 LASER PRODUCT

CLASS 3A LASER

Ordering Information

Single and Dual Wavelength OTDR

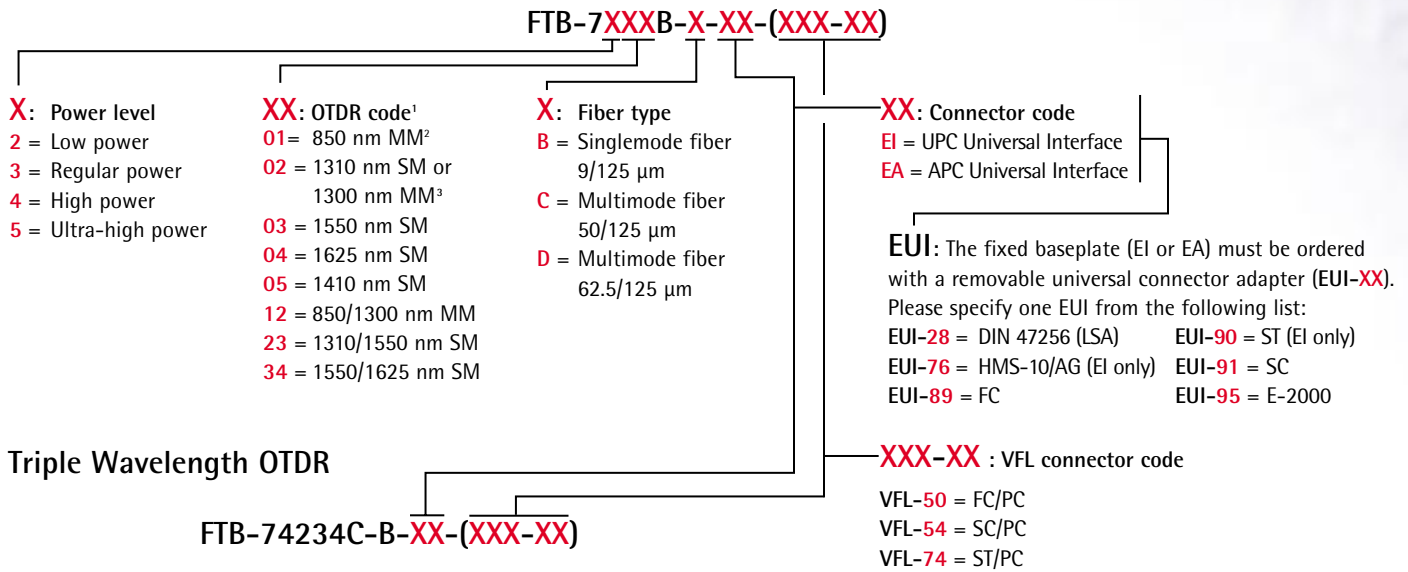

Triple Wavelength OTDR



FTB-74234C-B-XX-(XXX-XX)

High power OTDR (1310/1550/1625) for single mode fiber.

Note

1. Configurations not all available with selected power level.
2. Multimode only.
3. Depends on selected wavelength type.

Find out more about EXFO's extensive line of high-performance portable instruments by visiting our Web site at www.exfo.com

| | | | |
|--|---|--|--|
|  <p>Rugged Handheld Solutions</p> <ul style="list-style-type: none"> • OLTS • Power Meter • Light Source • Talk Set |  <p>UNIVERSAL TEST SYSTEM</p> <ul style="list-style-type: none"> • OTDR • OLTS • ORL • Switch | <p>Optical Fiber</p> <ul style="list-style-type: none"> • OSA • PMD • Chromatic Dispersion Analyzer • Multiwavelength Meter | <p>DWDM Test Systems</p> <ul style="list-style-type: none"> • 10/100 and Gigabit Ethernet • SONET/SDH (DSO to OC-192c) • SDH/PDH (64Kb/s to STM-64c) |
|--|---|--|--|

| | | | |
|------------------------|---|------------------------------------|--|
| CORPORATE HEADQUARTERS | 400 Godin Avenue | Vanier (Quebec) G1M 2K2 CANADA | Tel.: 1 418 683-0211 . Fax: 1 418 683-2170 |
| EXFO AMERICA | 4275 Kellway Circle, Suite 122 | Addison TX 75001 USA | Tel.: 1 800 663-3936 . Fax: 1 972 836-0164 |
| EXFO EUROPE | Le Dynasteur, 10/12 rue Andras Beck | 92366 Meudon la Forêt Cedex FRANCE | Tel.: +33.1.40.83.85.85 . Fax: +33.1.40.83.04.42 |
| EXFO ASIA-PACIFIC | 151 Chin Swee Road, #03-29 Manhattan House | SINGAPORE 169876 | Tel.: +65 6333 8241 . Fax: +65 6333 8242 |
| EXFO CHINA | Beijing New Century Hotel Office Tower, Room 1754-1755 No. 6 Southern Capital Gym Road | Beijing 100044 P. R. China | Tel.: +86 (10) 6849 2738 . Fax: +86 (10) 6849 2662 |

TOLL-FREE (USA and Canada) Tel.: 1 800 663-3936 www.exfo.com • info@exfo.com

EXFO is certified ISO 9001 and attests to the quality of these products. This device complies with Part 15 of the FCC Rules. Operation is subject to the following two conditions: (1) this device may not cause harmful interference, and (2) this device must accept any interference received, including interference that may cause undesired operation. EXFO has made every effort to ensure that the information contained in this specification sheet is accurate. However, we accept no responsibility for any errors or omissions, and we reserve the right to modify design, characteristics and products at any time without obligation. Units of measurement in this document conform to SI standards and practices.
Contact EXFO for prices and availability or to obtain the phone number of your local EXFO distributor.
 For the most recent version of this spec sheet, please go to the EXFO Web site at <http://www.exfo.com/support/techdocs.asp>
 In case of discrepancy, the Web version takes precedence over any printed literature.

