

# Fluke 830 Laser Shaft Alignment Tool

## Technical Data

The all new Fluke 830 Laser Shaft Alignment Tool is the ideal test tool to precision-align rotating shafts in your facility.

It's a known fact—all rotating machinery is susceptible to misalignment. If you're still using rulers and dial indicators to ensure your rotating machinery is properly aligned, you could be losing thousands of dollars per year in replacement bearing costs, hours of unnecessary repair time, and crippling unplanned downtime, not to mention taking years off your machine's useful life.

**There's more to shaft alignment than taking measurements and making adjustments—when uptime matters picking the right tool is critical.**

The Fluke 830 Laser Shaft Alignment tool is easy-to-use, giving you fast, accurate and actionable answers that will keep your plant up and running. When it comes to laser shaft alignment, data is good but answers are better.

Unlike using the straightedge method or dial indicators the Fluke 830 performs the complicated alignment calculations for you, meaning you'll have the answers you need to quickly align your machine and get your plant up and running fast. An enhanced user interface provides easy to understand results that don't require extensive alignment knowledge and the unique "All-in-One" result screen that shows you both coupling results and feet corrections (vertical and horizontal) in real terms making it easy to take corrective action.

Since machine downtime is costly, test repeatability is critical. The Fluke 830 uses a patented\* single laser precision alignment system that provides accurate and repeatable measurement results so you can be assured you're addressing misalignment problems properly.

High quality brackets ensure the sensor and prism don't slip as the shaft is rotated.



### Feature and benefits

- **Single laser measurement technology** means reduced errors from backlash resulting in better data accuracy
- **Intuitive guided user interface** quickly and easily complete machine alignments
- **Compass measurement mode** enables flexible, reliable and repeatable measurements using an activated electronic inclinometer
- **Dynamic machine tolerance check** provides continuous evaluation of alignment adjustments so you know when your machine is in acceptable range
- **Unique extend mode** handles gross misalignment by virtually increasing laser detector size
- **Data protection** ensures your data is there when you need it with auto save and resume capability

## Evaluate alignment in three simple steps

### 1 Setup

Step-by-step input of the machine dimensions.

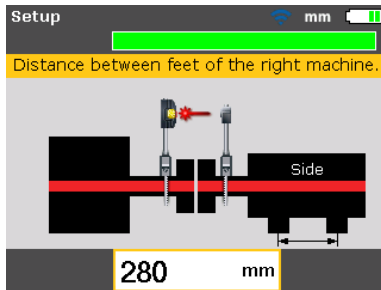

### 2 Measure

Rotate the shaft and receive instant measurement verification.

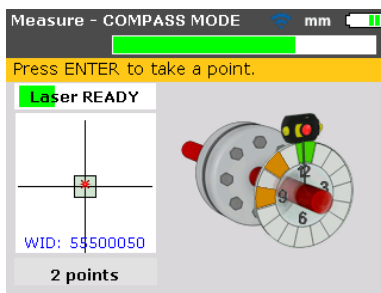

### 3 Diagnose

Actual correction numbers are given along with a 4-level color severity scale indicating whether your machine is misaligned.

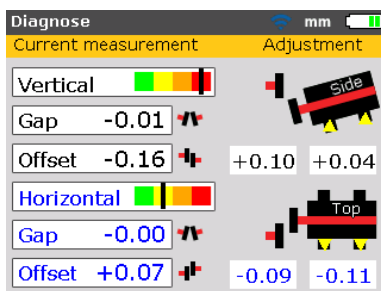

“Live” mode provides immediate dynamic feedback while you make alignment adjustments—eliminating the need to perform additional diagnostics.

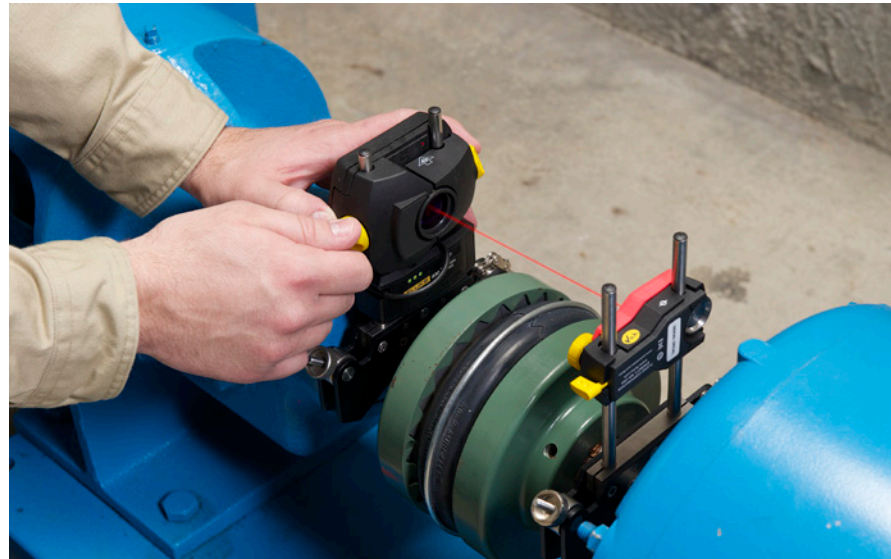

## Handling gross misalignment

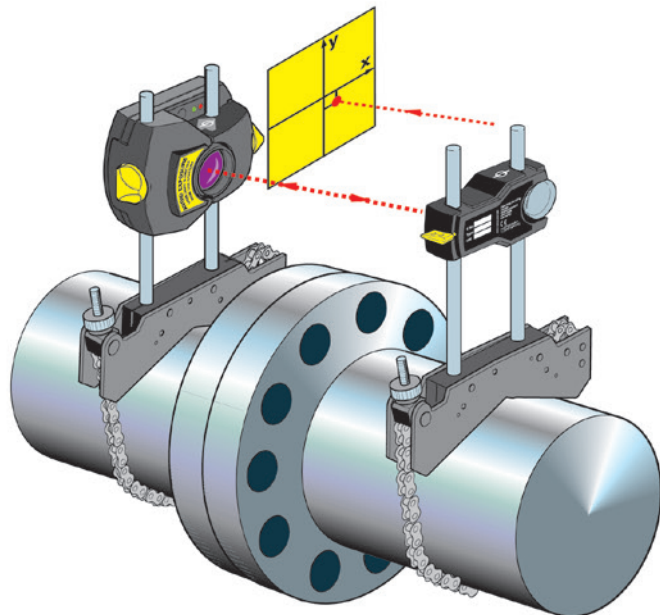

When machines are well outside of accepted tolerances it can be difficult to get accurate alignment readings. For these gross misalignment problems the Fluke 830 uses a unique “Extend” mode allowing for better measurement accuracy by automatically increasing the effective sensor measurement area. Increasing the sensor measurement area virtually allows the Fluke 830 to address gross misalignment quickly without the need to perform an initial rough alignment.

### Additional features and benefits:

1. Clock mode for vertical & flanged machines
2. Machine Flip to flip image of machine on screen for alignment jobs with obstructions
3. Resume mode to save your work and return back at the same step (anytime you need)

## Fluke predictive maintenance tools help keep your plant up and running

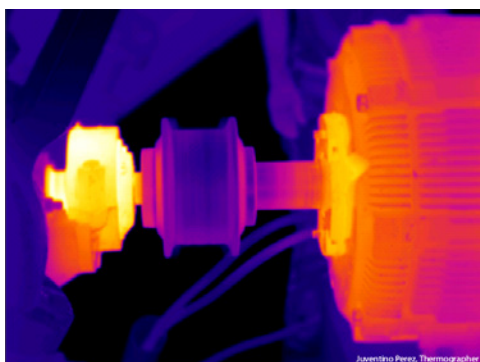

1. Identify a potential problem using a Fluke infrared camera.

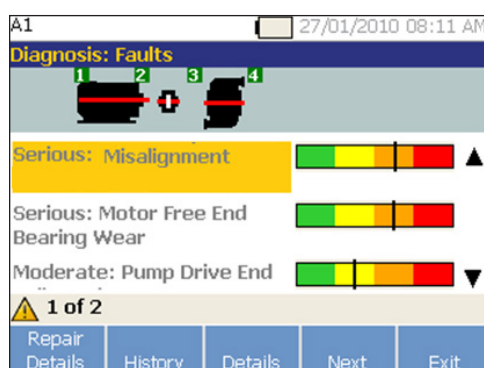

2. Diagnosis and repair recommendation using the Fluke vibration tool.

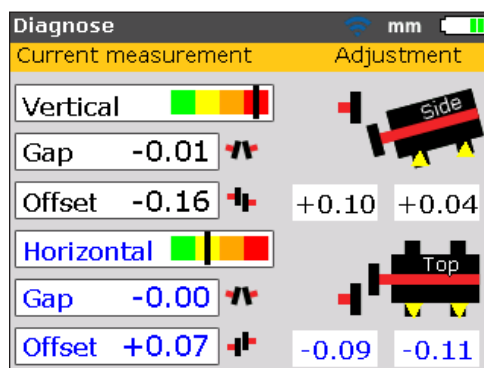

3. Corrective action using the Fluke 830 Laser Shaft Alignment.

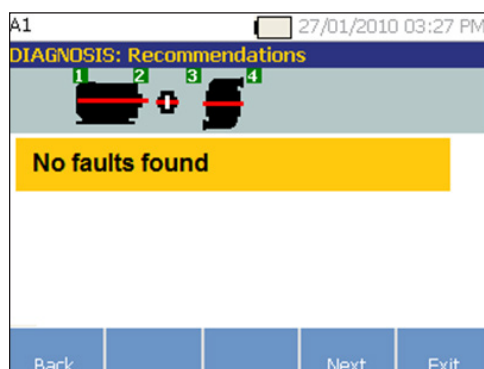

4. Result verification using the Fluke vibration tool.

Fluke offers a complete line of predictive maintenance tools designed to help keep your plant up and running. Whether you're using a Fluke vibration tester to diagnose fault and severity, or a Fluke infrared camera to evaluate machine health, Fluke predictive maintenance tools are designed to give you the answers you need to reduce unplanned downtime and decrease repair costs. The Fluke 830 Laser Shaft Alignment Tool uses a similar measurement process as the Fluke 810 Vibration Tester making laser shaft alignment as easy as 1-2-3. Just set up the unit, perform the test, and evaluate the diagnosis.

Using a Fluke infrared camera you can quickly identify possible machine health problems, and then use a Fluke vibration tester to further diagnose the problem and determine whether or not misalignment is present. Using the Fluke 830 Laser Shaft Alignment tool you can get the answers you need to correct misalignment, and then further verify your results with your Fluke infrared camera or vibration tester to check the machine health.

## Technical specifications

Computer	
CPU	Intel XScale PXA270 running at 312 MHz
Memory	64 MB RAM, 64 MB flash
Display	Type: TFT, transmissive (sunlight-readable), 65,535 colors, backlit LED Integrated light sensor for automated adjustment of the brightness to the display according to the lighting conditions which extends battery life Resolution: 320 x 240 pixel; Dimensions: 89 mm (3.5 in) diagonal Keyboard elements: Setup, measure, diagnose, menu, clear, enter, back keys, navigation cursor cross, alphanumeric keyboard and on/off button
LED indicators	Multicolor LED for laser status and alignment condition Multicolor LED for battery status
Power supply	Integrated Lithium-ion polymer rechargeable battery: 7.4 V/ 2.6 Ah (for optional computer) with typical operating time of 17 hours (based upon an operating cycle of 33 % measurement, 33 % computation and 33 % 'sleep' mode)
External interface	USB host and USB device (slave) Integrated wireless communication, Class 1, transmitting power 100 mW RS232 (serial) for sensor AC adapter/charger socket
Environmental protection	IP 65 (dustproof and water spray resistant), shockproof Relative humidity 10 % to 90 %
Operating temperature	-10 °C to 50 °C (14 °F to 122 °F)
Storage temperature	-20 °C to 60 °C (-4 °F to 140 °F)
Dimensions	220 mm x 165 mm x 45 mm (8.7 in x 6.5 in x 1.8 in)
Weight	742 g (1.64 lb)
Sensor	
Measurement principle	Coaxial, reflected laser beam
Environmental protection	IP 67 (submersible, dustproof)
Ambient light protection	Yes
Storage temperature	-20 °C to 80 °C (-4 °F to 176 °F)
Operating temperature	0 °C to 55 °C (32 °F to 131 °F)
Dimensions	107 mm x 70 mm x 49 mm (4 1/4 in x 2 3/4 in x 2 in)
Weight	177 g (6 1/2 oz)

## Technical specifications continued

Laser	Type: Ga-Al-As semiconductor laser
	Wavelength (typical) 675 nm (red, visible)
	Safety class: Class 2, FDA 21 CFR 1000 and 1040
	Beam power: < 1 mW
	Safety precautions: Do not look into laser beam
Detector	Measurement area: unlimited, dynamically extendible (U.S. Patent 6,040,903)
	Resolution: 1 µm; Accuracy (avg): > 98 %
Inclinometer	Measurement range: 0° to 360°; Resolution: < 1°
<b>Prism</b>	
Type	90° roof prism; Accuracy (avg): > 99 %
Environmental protection	IP 67 (submersible, dustproof)
Operating temperature	-20 °C to 60 °C (-4 °F to 140 °F)
Storage temperature	-20 °C to 80 °C (-4 °F to 176 °F)
Dimensions	100 mm x 41 mm x 35 mm (4 in x 1 5/8 in x 1 3/8 in)
Weight	65 g (2 1/2 oz.)
<b>Carrying case</b>	
Dimensions	565 mm x 343 mm x 127 mm (22 1/4 in x 13 1/2 in x 5 in)
Weight, including all standard parts	5.6 kg (12.3 lb)

## Ordering information

**Fluke-830** Fluke 830 Laser Shaft Alignment Tool

**Fluke-830/MAGNET** Compact Magnetic Sensor/Prism Mounting Bracket Set

**Fluke-830/SHIMS** Precision Alignment Shim Kit

**Included accessories:** Laser sensor, laser prism, chain-type mounting bracket with 150 mm support posts (2x), 300 mm support post (4x), micro fiber cleaning cloth, sensor cable, PC cable, USB drive, USB drive cable, tape measure, wireless Bluetooth module, power adapter, instruction kit and carrying case

**Fluke.** *Keeping your world up and running.*<sup>®</sup>

**Fluke Corporation**  
PO Box 9090, Everett, WA 98206 U.S.A.

**Fluke Europe B.V.**  
PO Box 1186, 5602 BD  
Eindhoven, The Netherlands

**For more information call:**  
In the U.S.A. (800) 443-5853 or  
Fax (425) 446-5116  
In Europe/M-East/Africa +31 (0)40 267 5100 or  
Fax +31 (0)40 267 5222  
In Canada (800)-36-FLUKE or  
Fax (905) 890-6866  
From other countries +1 (425) 446-5500 or  
Fax +1 (425) 446-5116  
Web access: <http://www.fluke.com>

©2014 Fluke Corporation.  
Specifications subject to change without notice.  
Printed in U.S.A. 5/2014 6002721B\_EN

**Modification of this document is not permitted without written permission from Fluke Corporation.**