

# 80 Series III

Multimeters

## Service Information

## **Lifetime Limited Warranty**

Each Fluke 20, 70, 80, 170 and 180 Series DMM will be free from defects in material and workmanship for its lifetime. As used herein, "lifetime" is defined as seven years after Fluke discontinues manufacturing the product, but the warranty period shall be at least ten years from the date of purchase. This warranty does not cover fuses, disposable batteries, damage from neglect, misuse, contamination, alteration, accident or abnormal conditions of operation or handling, including failures caused by use outside of the product's specifications, or normal wear and tear of mechanical components. This warranty covers the original purchaser only and is not transferable.

For ten years from the date of purchase, this warranty also covers the LCD. Thereafter, for the lifetime of the DMM, Fluke will replace the LCD for a fee based on then current component acquisition costs.

To establish original ownership and prove date of purchase, please complete and return the registration card accompanying the product, or register your product on <http://www.fluke.com>. Fluke will, at its option, repair at no charge, replace or refund the purchase price of a defective product purchased through a Fluke authorized sales outlet and at the applicable international price. Fluke reserves the right to charge for importation costs of repair/replacement parts if the product purchased in one country is sent for repair elsewhere.

If the product is defective, contact your nearest Fluke authorized service center to obtain return authorization information, then send the product to that service center, with a description of the difficulty, postage and insurance prepaid (FOB Destination). Fluke assumes no risk for damage in transit. Fluke will pay return transportation for product repaired or replaced in-warranty. Before making any non-warranty repair, Fluke will estimate cost and obtain authorization, then invoice you for repair and return transportation.

**THIS WARRANTY IS YOUR ONLY REMEDY. NO OTHER WARRANTIES, SUCH AS FITNESS FOR A PARTICULAR PURPOSE, ARE EXPRESSED OR IMPLIED. FLUKE SHALL NOT BE LIABLE FOR ANY SPECIAL, INDIRECT, INCIDENTAL OR CONSEQUENTIAL DAMAGES OR LOSSES, INCLUDING LOSS OF DATA, ARISING FROM ANY CAUSE OR THEORY. AUTHORIZED RESELLERS ARE NOT AUTHORIZED TO EXTEND ANY DIFFERENT WARRANTY ON FLUKE'S BEHALF.** Since some states do not allow the exclusion or limitation of an implied warranty or of incidental or consequential damages, this limitation of liability may not apply to you. If any provision of this warranty is held invalid or unenforceable by a court or other decision-maker of competent jurisdiction, such holding will not affect the validity or enforceability of any other provision.

# Table of Contents

Title	Page
Introduction .....	1
Precautions and Safety Information .....	2
International Symbols.....	2
Safety Information.....	3
Specifications .....	4
Accuracy .....	4
General .....	4
AC Voltage Specifications (Models 85 and 87) .....	5
AC Voltage Specifications (Model 83).....	5
DC Voltage, Resistance, and Conductance Specifications.....	5
Current Specifications.....	6
Capacitance and Diode Function Specifications .....	6
Frequency Counter Specifications .....	6
Frequency Counter Sensitivity and Trigger Levels .....	7
MIN MAX Recording Specifications .....	7
Electrical Characteristics of the Terminals.....	8
Required Equipment.....	8
Basic Maintenance .....	9
Opening the Meter Case.....	9
Removing and Reinserting the Circuit Board Assembly .....	10
Reassembling the Meter Case .....	11
Replacing the Battery.....	11
Testing Fuses (F1 and F2).....	12
Replacing Fuses .....	13
Cleaning .....	13
Input Terminals.....	13
Rotary Switch .....	14
Performance Tests .....	14
A Basic Operability Test.....	14
Testing the Display .....	15
Testing the Rotary Switch.....	15
Testing the AC Voltage Function .....	16
Testing the Frequency Function.....	17
Testing the Frequency Sensitivity and Trigger Level.....	17
Testing DC Voltage .....	18
Testing the PEAK MIN MAX Function (Model 87 only).....	18

Testing the mV DC Function .....	19
Testing the Resistance Function .....	19
Testing the Capacitance Function .....	20
Checking the Diode Test Function.....	20
Testing the Milliamp (mA) Function .....	21
Testing the Microamp ( $\mu$ A) Function .....	21
Testing the Amp (A) Function .....	22
Calibration .....	23
Calibrating the Model 85 and 87 III.....	23
Calibrating the Model 83 III .....	25
Parts and Accessories .....	25

# ***List of Tables***

<b>Table</b>	<b>Title</b>	<b>Page</b>
1.	International Symbols .....	2
2.	Required Tools and Equipment .....	9
3.	Rotary Switch Test .....	16
4.	AC Voltage Test .....	16
5.	Frequency Test.....	17
6.	Frequency Counter Sensitivity and Trigger Level Tests .....	18
7.	DC Voltage Test .....	18
8.	Peak MIN MAX Test.....	19
9.	Ohms Tests .....	20
10.	Capacitance Tests .....	20
11.	mA Tests .....	21
12.	$\mu$ A Tests.....	22
13.	Current Tests.....	22
14.	Replacement Parts .....	25
15.	Accessories .....	26



# *List of Figures*

<b>Figure</b>	<b>Title</b>	<b>Page</b>
1.	Disassembly Details.....	10
2.	Battery and Fuse Replacement .....	11
3.	Testing the Current Input Fuses.....	12
4.	Display Test .....	15
5.	Calibration Adjustment Points.....	24
6.	Replaceable Parts.....	26





## ***Introduction***

### **⚠ Warning**

**To avoid shock or injury, do not perform the verification tests or calibration procedures described in this manual unless you are qualified to do so.**

**The information provided in this document is for the use of qualified personnel only.**

### **Caution**

**The 80 III Multimeter contains parts that can be damaged by static discharge.**

**Follow the standard practices for handling static sensitive devices.**

The *80 Series III Service Information* provides the following information:

- Precautions and safety information
- Specifications
- Basic maintenance (cleaning, replacing the battery and fuses)
- Performance test procedures
- Calibration and calibration adjustment procedures
- Accessories and replaceable parts

For complete operating instructions, refer to the *80 Series III Users Manual*.

To contact Fluke, call:

USA: 1-888-99-FLUKE (1-888-993-5853)

Canada: 1-800-36-FLUKE (1-800-363-5853)

Europe: +31 402-678-200

Japan: +81-3-3434-0181

Singapore: +65-738-5655

Anywhere in the world: +1-425-446-5500

For additional information about Fluke, its products, and services, visit Fluke's web site at:

[www.fluke.com](http://www.fluke.com)

## Precautions and Safety Information

Use the Meter only as described in the *Users Manual*. If you do not do so, the protection provided by the Meter may be impaired.













Read the “Safety Information” page before servicing this product.

In this manual, a **Warning** identifies conditions and actions that pose hazard(s) to the user; a **Caution** identifies conditions and actions that may damage the Meter or the test instruments.

## International Symbols

International symbols used on the Meter and in this manual are explained in Table 1.

**Table 1. International Symbols**

Symbol	Meaning	Symbol	Meaning
	Alternating current		Earth ground
	Direct current		Fuse
	Alternating or direct current		Conforms to European Union directives
	Refer to the manual. Important information.		Conforms to relevant Canadian Standards Association directives
	Take appropriate precautions. Hazardous voltage may be present		Double insulated
	Battery		IEC overvoltage category III

## Safety Information

### **⚠ Warnings and Precautions**

To avoid possible electric shock or personal injury, and to avoid possible damage to the Meter or to the equipment under test, follow these guidelines:

- Before using the Meter inspect the case. Do not use the Meter if it is damaged. Look for cracks or missing plastic. Pay particular attention to the insulation around the connectors.
- Inspect the test leads for damaged insulation or exposed metal. Check the test leads for continuity. Replace damaged test leads before using the Meter.
- Verify the Meter's operation by measuring a known voltage. Do not use the Meter if it operates abnormally. Protection may be impaired. When in doubt, have the Meter serviced.
- Do not apply more than the rated voltage, as marked on the Meter, between the terminals or between any terminal and earth ground.
- Use caution when working with voltages above 30 V ac rms, 42 V ac peak, or 60 V dc. These voltages pose a shock hazard.
- Use the proper terminals, function, and range for your measurements.
- Do not operate the Meter around explosive gas, vapor, or dust.
- When using the probes, keep your fingers behind the finger guards.
- When making connections, connect the common test lead before connecting the live test lead; when disconnecting, disconnect the live test lead before disconnecting the common test lead.
- Disconnect circuit power and discharge all high-voltage capacitors before testing resistance, continuity, diodes, or capacitance.
- Before measuring current, check the Meter's fuses (see "Testing Fuses") and turn OFF power to the circuit before connecting the Meter to the circuit.
- Do not operate the Meter with the case (or part of the case) removed.
- Use only a single 9 V battery, properly installed in the battery receptacle, to power the Meter.
- Replace the battery as soon as the battery indicator (🔋) appears. With a low battery, the Meter might produce false readings that can lead to electric shock and personal injury,
- Remove test leads from the Meter before opening the Meter case.
- When servicing the Meter, use only specified replacement parts.

## Specifications

### Accuracy

Accuracy is given for a period of one year after calibration, at 18 °C to 28 °C, with relative humidity up to 90 % as:

$$\pm([\% \text{ of reading}] + [\text{number of least significant digits}])$$

For Model 87 in the 4 ½-digit mode, multiply the number of least significant digits (counts) by 10. AC conversions are ac-coupled and valid from 5 % to 100 % of range.

Models 85 and 87 are true rms responding. AC crest factor can be up to 3 at full scale, 6 at half scale. For non-sinusoidal wave forms add  $-(2 \% \text{ reading} + 2 \% \text{ full scale})$  typical, for a crest factor up to 3.

### General

<b>Maximum Voltage between any Terminal and Earth Ground</b>	1000 V rms
<b>△ Fuse Protection for mA or µA inputs</b> <b>△ Fuse Protection for A input</b>	44/100 A, 1000 V FAST Fuse 11 A, 1000 V FAST Fuse
<b>Display</b>	Digital: 4000 counts updates 4/sec; (Model 87 also has 19,999 counts in 4½-digit mode, updates 1/sec.). Analog: updates 40/sec. Frequency: 19,999 counts, updates 3/sec at >10 Hz. Model 87: 4 x 32 segments (equivalent to 128); Models 83, 85: 43 segments.
<b>Temperature</b>	Operating: -20 °C to +55 °C; Storage: -40 °C to +60 °C
<b>Altitude</b>	Operating: 2000 m; Storage: 10,000 m
<b>Temperature Coefficient</b>	0.05 x (specified accuracy)/ °C (<18 °C or >28 °C)
<b>Electromagnetic Compatibility</b>	In an RF field of 1 V/m on all ranges and functions except capacitance: Models 85 and 87 Total Accuracy = Specified Accuracy + 2.5 % of range. Model 83 Total Accuracy = Specified Accuracy + 0.3 % of range. Capacitance not specified in RF fields. Above 1 V/m is not specified.
<b>Relative Humidity</b>	0 % to 90 % (0 °C to 35 °C); 0 % to 70 % (35 °C to 55 °C)
<b>Battery Type</b>	9 V zinc, NEDA 1604 or 6F22 or 006P
<b>Battery Life</b>	400 hrs typical with alkaline (with backlight off)
<b>Shock Vibration</b>	Per MIL-T-28800 for a Class 2 instrument
<b>Size (H x W x L)</b>	1.25 in x 3.41 in x 7.35 in (3.1 cm x 8.6 cm x 18.6 cm)
<b>Size with Holster and Flex-Stand</b>	2.06 in x 3.86 in x 7.93 in (5.2 cm x 9.8 cm x 20.1 cm)
<b>Weight</b>	12.5 oz (355 g)
<b>Weight with Holster and Flex-Stand</b>	22.0 oz (624 g)
<b>Safety</b>	Complies with ANSI/ISA S82.01-1994, CSA 22.2 No. 1010.1:1992 to 1000 V Overvoltage Category III. UL listed to UL3111-1. Licensed by TÜV to EN61010-1.

### AC Voltage Specifications (Models 85 and 87)

Function	Range	Resolution	Accuracy <sup>1</sup>			
			50-60 Hz	45 Hz - 1 kHz	1-5 kHz	5-20 kHz <sup>2</sup>
$\tilde{V}^3$	400.0 mV	0.1 mV	$\pm(0.7\% + 4)$	$\pm(1.0\% + 4)$	$\pm(2.0\% + 4)$	$\pm(2.0\% + 20)$
	4.000 V	0.001 V	$\pm(0.7\% + 2)$	$\pm(1.0\% + 4)$	$\pm(2.0\% + 4)$	$\pm(2.0\% + 20)$
	40.00 V	0.01 V	$\pm(0.7\% + 2)$	$\pm(1.0\% + 4)$	$\pm(2.0\% + 4)$	$\pm(2.0\% + 20)$
	400.0 V	0.1 V	$\pm(0.7\% + 2)$	$\pm(1.0\% + 4)$	$\pm(2.0\% + 4)^4$	unspecified
	1000 V	1 V	$\pm(0.7\% + 2)$	$\pm(1.0\% + 4)^5$	unspecified	unspecified

- For extended use at high RH, change the 400 mV and 4.0 V ac accuracy specification to  $\pm(1.5\% + 4)$  counts for 45 Hz to 1 kHz and  $\pm(3.0\% + 25)$  counts for 5 kHz to 20 kHz.
- Below 10 % of range, add 6 counts.
- Models 85 and 87 are true rms responding Meters. When the input leads are shorted together in the ac functions, the Meters display a reading (typically <25 counts) caused by internal amplifier noise. The accuracy on Models 85 and 87 is not significantly affected by this internal offset when measuring inputs that are within 5 % to 100 % of the selected range. When the rms value of the two values (5 % of range and internal offset) is calculated, the effect is minimal as shown in the following example where  $20.0 = 5\%$  of 400 mV range, and 2.5 is the internal offset:  $RMS = \sqrt{(20.0)^2 + (2.5)^2} = 20.16$ . If you use the REL function to zero the display when using the ac functions, a constant error that is equal to the internal offset will result.
- Frequency range: 1 kHz to 2.5 kHz.
- Below 10 % of range, add 16 counts.

### AC Voltage Specifications (Model 83)

Function	Range	Resolution	Accuracy <sup>1</sup>		
			50 Hz - 60 Hz	45 Hz - 1 kHz	1 kHz - 5 kHz
$\tilde{V}^2$	400.0 mV	0.1 mV	$\pm(0.5\% + 4)$	$\pm(1.0\% + 4)$	$\pm(2.0\% + 4)$
	4.000 V	0.001 V	$\pm(0.5\% + 2)$	$\pm(1.0\% + 4)$	$\pm(2.0\% + 4)$
	40.00 V	0.01 V	$\pm(0.5\% + 2)$	$\pm(1.0\% + 4)$	$\pm(2.0\% + 4)$
	400.0 V	0.1 V	$\pm(0.5\% + 2)$	$\pm(1.0\% + 4)$	$\pm(2.0\% + 4)^3$
	1000 V	1 V	$\pm(0.5\% + 2)$	$\pm(1.0\% + 4)$	unspecified

- For extended use at high RH, change the 400 mV and 4.0 V ac accuracy specification to  $\pm(1.5\% + 4)$  counts for 45 Hz to 1 kHz and  $\pm(3.0\% + 25)$  counts for 5 kHz to 20 kHz.
- Below a reading of 200 counts, add 10 counts.
- Frequency range: 1 kHz to 2.5 kHz.

### DC Voltage, Resistance, and Conductance Specifications



Function	Range	Resolution	Accuracy <sup>1</sup>		
			Model 83	Model 85	Model 87
$\bar{V}$	4.000 V	0.001 V	$\pm(0.1\% + 1)$	$\pm(0.08\% + 1)$	$\pm(0.05\% + 1)$
	40.00 V	0.01 V	$\pm(0.1\% + 1)$	$\pm(0.08\% + 1)$	$\pm(0.05\% + 1)$
	400.0 V	0.1 V	$\pm(0.1\% + 1)$	$\pm(0.08\% + 1)$	$\pm(0.05\% + 1)$
	1000 V	1 V	$\pm(0.1\% + 1)$	$\pm(0.08\% + 1)$	$\pm(0.05\% + 1)$
$\bar{mV}$	400.0 mV	0.1 mV	$\pm(0.3\% + 1)$	$\pm(0.1\% + 1)$	$\pm(0.1\% + 1)$
$\Omega$	400.0 $\Omega$	0.1 $\Omega$	$\pm(0.4\% + 2)^2$	$\pm(0.2\% + 2)^2$	$\pm(0.2\% + 2)^2$
	4.000 k $\Omega$	0.001 k $\Omega$	$\pm(0.4\% + 1)$	$\pm(0.2\% + 1)$	$\pm(0.2\% + 1)$
	40.00 k $\Omega$	0.01 k $\Omega$	$\pm(0.4\% + 1)$	$\pm(0.2\% + 1)$	$\pm(0.2\% + 1)$
	400.0 k $\Omega$	0.1 k $\Omega$	$\pm(0.7\% + 1)$	$\pm(0.6\% + 1)$	$\pm(0.6\% + 1)$
	4.000 M $\Omega$	0.001 M $\Omega$	$\pm(0.7\% + 1)$	$\pm(0.6\% + 1)$	$\pm(0.6\% + 1)$
nS	40.00 M $\Omega$	0.01 M $\Omega$	$\pm(1.0\% + 3)$	$\pm(1.0\% + 3)$	$\pm(1.0\% + 3)$
	40.00 nS	0.01 nS	$\pm(1.0\% + 10)$	$\pm(1.0\% + 10)$	$\pm(1.0\% + 10)$

- For extended use at high RH, change the 400 mV and 4.0 V ac accuracy specification to  $\pm(1.5\% + 4)$  counts for 45 Hz to 1 kHz and  $\pm(3.0\% + 25)$  counts for 5 kHz to 20 kHz.
- When using the REL  $\Delta$  function to compensate for offsets.

### Current Specifications

Function	Range	Resolution	Accuracy <sup>1</sup>			Burden Voltage (typical)
			Model 83 <sup>2</sup>	Model 85 <sup>3,4</sup>	Model 87 <sup>3,4</sup>	
<b>mA A~</b> (45 Hz to 2 kHz)	40.00 mA	0.01 mA	$\pm(1.2\% + 2)^6$	$\pm(1.0\% + 2)^6$	$\pm(1.0\% + 2)$	1.8 mV/mA
	400.0 mA	0.1 mA	$\pm(1.2\% + 2)^6$	$\pm(1.0\% + 2)^6$	$\pm(1.0\% + 2)$	1.8 mV/mA
	4000 mA <sup>5</sup>	1 mA	$\pm(1.2\% + 2)^6$	$\pm(1.0\% + 2)^6$	$\pm(1.0\% + 2)$	0.03 V/A
	10.00 A <sup>5</sup>	0.01 A	$\pm(1.2\% + 2)^6$	$\pm(1.0\% + 2)^6$	$\pm(1.0\% + 2)$	0.03 V/A
<b>mA A==</b>	40.00 mA	0.01 mA	$\pm(0.4\% + 4)$	$\pm(0.2\% + 4)$	$\pm(0.2\% + 4)$	1.8 mV/mA
	400.0 mA	0.1 mA	$\pm(0.4\% + 2)$	$\pm(0.2\% + 2)$	$\pm(0.2\% + 2)$	1.8 mV/mA
	4000 mA <sup>5</sup>	1 mA	$\pm(0.4\% + 4)$	$\pm(0.2\% + 4)$	$\pm(0.2\% + 4)$	0.03 V/A
	10.00 A <sup>5</sup>	0.01 A	$\pm(0.4\% + 2)$	$\pm(0.2\% + 2)$	$\pm(0.2\% + 2)$	0.03 V/A
<b>μA ~</b> (45 Hz to 2 kHz)	400.0 μA	0.1 μA	$\pm(1.2\% + 2)^6$	$\pm(1.0\% + 2)^6$	$\pm(1.0\% + 2)$	100 μV/μA
	4000 μA	1 μA	$\pm(1.2\% + 2)^6$	$\pm(1.0\% + 2)^6$	$\pm(1.0\% + 2)$	100 μV/μA
<b>μA ==</b>	400.0 μA	0.1 μA	$\pm(0.4\% + 4)$	$\pm(0.2\% + 4)$	$\pm(0.2\% + 4)$	100 μV/μA
	4000 μA	1 μA	$\pm(0.4\% + 2)$	$\pm(0.2\% + 2)$	$\pm(0.2\% + 2)$	100 μV/μA
<ol style="list-style-type: none"> <li>For extended use at high RH, change the 400 mV and 4.0 V ac accuracy specification to <math>\pm(1.5\% + 4</math> counts) for 45 Hz to 1 kHz and <math>\pm(3.0\% + 25</math> counts) for 5 kHz to 20 kHz.</li> <li>AC conversion for Model 83 is ac coupled and calibrated to the rms value of a sinewave input.</li> <li>AC conversions for Models 85 and 87 are ac coupled, true rms responding, and valid from 5 % to 100 % of range.</li> <li>See note 2 in under "AC Voltage Specifications (Models 85 and 87)."</li> <li>10 A continuous; 20 A for 30 seconds maximum: Accuracy unspecified over 10 A.</li> <li>Below a reading of 200 counts, add 10 counts.</li> </ol>						

### Capacitance and Diode Function Specifications

Function	Range	Resolution	Accuracy <sup>1</sup>
	5.00 nF	0.01 nF	$\pm(1\% + 3)$
	0.0500 μF	0.0001 μF	$\pm(1\% + 3)$
	0.500 μF	0.001 μF	$\pm(1\% + 3)$
	5.00 μF	0.01 μF	$\pm(1.9\% + 3)$
	3.000 V	0.001 V	$\pm(2\% + 1)$
<ol style="list-style-type: none"> <li>With a film capacitor or better, using Relative mode to zero residual. See "Accuracy" earlier in the specifications for a complete explanation.</li> </ol>			

### Frequency Counter Specifications

Function	Range	Resolution	Accuracy <sup>1</sup>
Frequency (0.5 Hz to 200 kHz, pulse width >2 μs)	199.99	0.01 Hz	$\pm(0.005\% + 1)$
	1999.9	0.1 Hz	$\pm(0.005\% + 1)$
	19.999 kHz	0.001 kHz	$\pm(0.005\% + 1)$
	199.99 kHz	0.01 kHz	$\pm(0.005\% + 1)$
	>200 kHz	0.1 kHz	unspecified
<ol style="list-style-type: none"> <li>See "Accuracy" earlier in the specifications for a complete explanation.</li> </ol>			

**Frequency Counter Sensitivity and Trigger Levels**

Input Range <sup>1</sup>	Minimum Sensitivity (RMS Sinewave)		Approximate Trigger Level (DC Voltage Function)
	5 Hz - 20 kHz	0.5 Hz - 200 kHz	
400 mV dc	70 mV (to 400 Hz)	70 mV (to 400 Hz)	40 mV
400 mV dc	150 mV	150 mV	—
4 V	0.3 V	0.7 V	1.7 V
40 V	3 V	7 V ( $\leq 140$ kHz)	4 V
400 V	30 V	70 V ( $\leq 14.0$ kHz)	40 V
1000 V	300 V	700 V ( $\leq 1.4$ kHz)	400 V
Duty Cycle Range	Accuracy		
0.0 to 99.9 %	Within $\pm(0.05 \%$ per kHz + 0.1 %) of full scale for a 5 V logic family input on the 4 V dc range.  Within $\pm((0.06 \times \text{Voltage Range}/\text{Input Voltage}) \times 100 \%)$ of full scale for sine wave inputs on ac voltage ranges.		
1. Maximum input for specified accuracy = 10X Range or 1000 V.			

**MIN MAX Recording Specifications**

Model	Nominal Response	Accuracy
83	100 ms to 80 % 1 s	Specified accuracy $\pm 12$ counts for changes $>200$ ms in duration ( $\pm 40$ counts in ac with beeper on).  Same as specified accuracy for changes $>2$ seconds in duration ( $\pm 40$ counts in ac with beeper on).
85, 87	100 ms to 80 % (DC functions) 120 ms to 80 % (AC functions) 1 s 250 $\mu$ s (Model 87 only)	Specified accuracy $\pm 12$ counts for changes $>200$ ms in duration.  Specified accuracy $\pm 40$ counts for changes $>350$ ms and inputs $>25 \%$ of range.  Same as specified accuracy for changes $>2$ seconds in duration. Specified accuracy $\pm 100$ counts for changes $>250 \mu$ s in duration.

**Electrical Characteristics of the Terminals**

$\bar{\bar{V}}$	<b>Overload Protection<sup>1</sup>:</b> 1000 V rms <b>Input Impedance (nominal):</b> 10 M $\Omega$ <100 pF <b>Common Mode Rejection Ratio:</b> >120 dB at dc, 50 Hz or 60 Hz (1 k $\Omega$ unbalance) <b>Normal Mode Rejection:</b> >60 dB at 50 Hz or 60 Hz
$m\bar{\bar{A}}$	<b>Overload Protection<sup>1</sup>:</b> 1000 V rms <b>Input Impedance (nominal):</b> 10 M $\Omega$ <100 pF <b>Common Mode Rejection Ratio:</b> >120 dB at dc, 50 Hz or 60 Hz (1 k $\Omega$ unbalance) <b>Normal Mode Rejection:</b> >60 dB at 50 Hz or 60 Hz
$\tilde{V}$	<b>Overload Protection<sup>1</sup>:</b> 1000 V rms <b>Input Impedance (nominal):</b> 10 M $\Omega$ <100 pF (ac-coupled) <b>Common Mode Rejection Ratio:</b> >60 dB, dc to 60 Hz (1 k $\Omega$ unbalance)
$\Omega$	<b>Overload Protection<sup>1</sup>:</b> 1000 V rms <b>Open Circuit Test Voltage:</b> <1.3 V dc <b>Full Scale Voltage:</b> To 4.0 M $\Omega$ : <450 mV dc 40 M $\Omega$ or nS V1.3 V dc <b>Typical Short Circuit Current:</b> 400 $\Omega$ : 200 $\mu$ A 4 k $\Omega$ : 80 $\mu$ A 40 k $\Omega$ : 12 $\mu$ A 400 k $\Omega$ : 1.4 $\mu$ A 4 M $\Omega$ : 0.2 $\mu$ A 40 M $\Omega$ : 0.2 $\mu$ A
$\rightarrow\pm$	<b>Overload Protection<sup>1</sup>:</b> 1000 V rms <b>Open Circuit Test Voltage:</b> <3.9 V dc <b>Full Scale Voltage:</b> 3.000 Vdc <b>Typical Short Circuit Current:</b> 0.6 mA typical
1. 10 <sup>6</sup> V Hz maximum.	

**Required Equipment**

Required equipment is listed in Table 2. If the recommended models are not available, equipment with equivalent specifications may be used.

Repairs or servicing should be performed only by qualified personnel.



**Table 2. Required Equipment**

Equipment	Required Characteristics	Recommended Model
Calibrator	AC Voltage Range: 0-1000V ac Accuracy: $\pm 0.12\%$ Frequency Range: 60-20000 Hz Accuracy: $\pm 3\%$  DC Voltage Range: 0-1000V dc Accuracy: $\pm 0.012\%$  Current Range: 350 $\mu$ A-2A Accuracy: AC (60 Hz to 1 kHz): $\pm 0.25\%$ DC: $\pm 0.05\%$  Frequency Source: 19.999 kHz - 199.99 kHz Accuracy: $\pm 0.0025\%$ Amplitude: 150 mV to 6V RMS Accuracy: $\pm 5\%$  Range: 1 $\Omega$ - 100 M $\Omega$ Accuracy: 0.065%	Fluke 5500A Multi-Product Calibrator or equivalent

## Basic Maintenance

### **⚠ Warning**

**To avoid shock, remove the test leads and any input signals before opening the case or replacing the battery or fuses.**

### Opening the Meter Case

#### **Caution**

**To avoid unintended circuit shorting, always place the uncovered Meter assembly on a protective surface. When the case of the Meter is open, circuit connections are exposed.**

To open the Meter case, refer to Figures 1 and 2 and do the following:

1. Disconnect test leads from any live source, turn the rotary switch to OFF, and remove the test leads from the front terminals.
2. Remove the battery door by using a flat-blade screwdriver to the turn the battery door screws 1/4-turn counterclockwise.
3. The case bottom is secured to the case top by three screws and two internal snaps (at the LCD end). Using a Phillips-head screwdriver, remove the three screws.

#### *Note*

*The gasket between the two case halves is sealed to, and must remain with, the case bottom. The case top lifts away from the gasket easily. Do not damage the gasket or attempt to separate the case bottom from the gasket.*

4. Hold the Meter display side up.
5. Lifting up on the input terminal end, disengage the case top from the gasket.
6. Gently unsnap the case top at the display end. (See Figure 2).

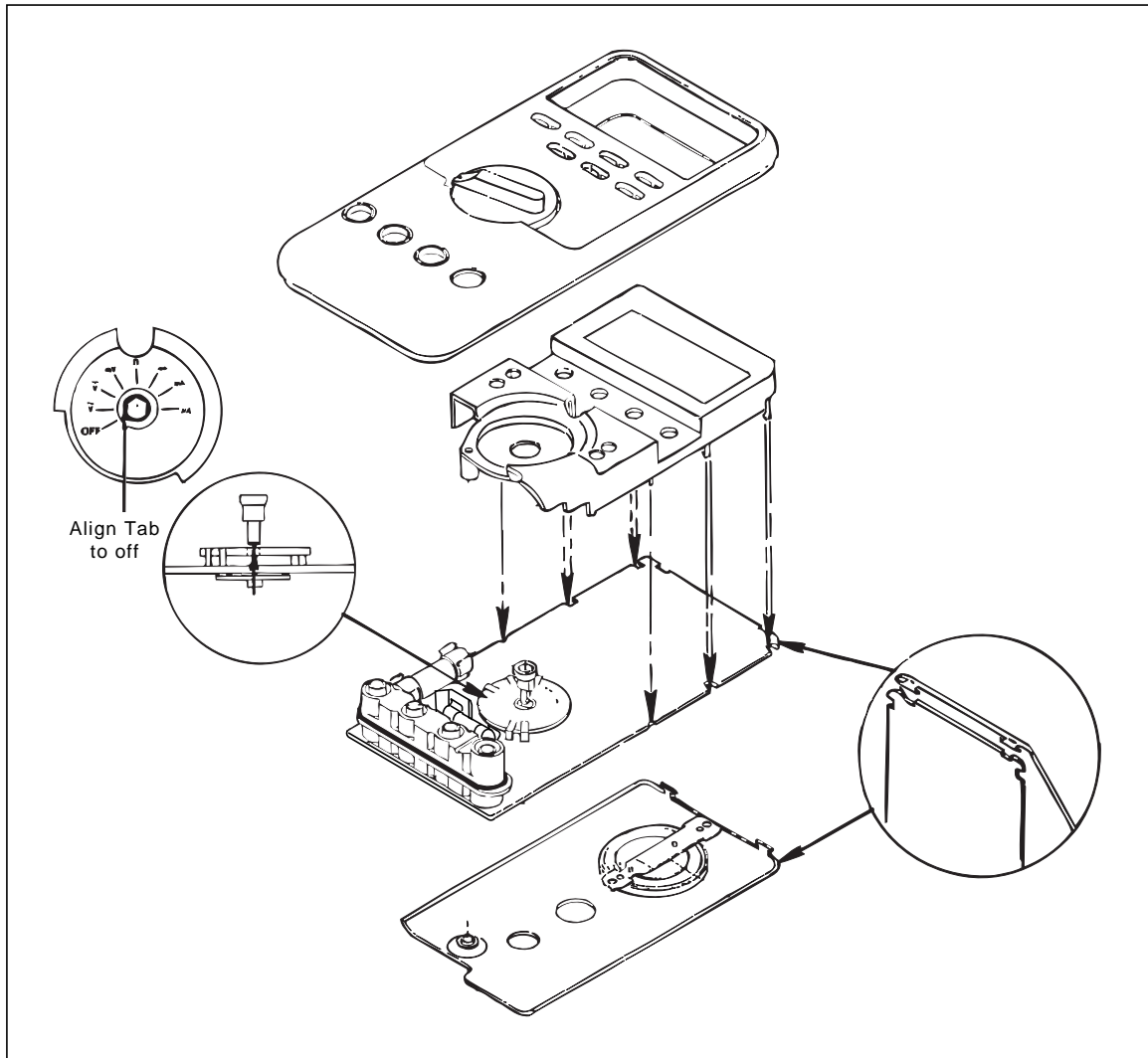

**Figure 1. Disassembly Details**

ek7f.eps

### ***Removing and Reinserting the Circuit Board Assembly***

Once the case has been opened, the shields can be disconnected from the circuit board assembly as follows:

1. Remove the one Phillips-head screw securing the back shield to the circuit assembly. Then remove the back shield.
2. The front shield can now be disconnected from the circuit assembly by detaching the four snaps (one at a time) found on the top-front.

Be gentle when detaching or attaching the four snaps. Excessive force can deform or fracture the snaps.

3. To reinsert the circuit assembly, push the front shield on so that the four clips engage gently and simultaneously.
4. Turn the assembly over, and replace the Phillips-head screw and back shield.

Ensure that the shields are tightly attached. Properly fitted shields are required for the Meter to perform to specification.

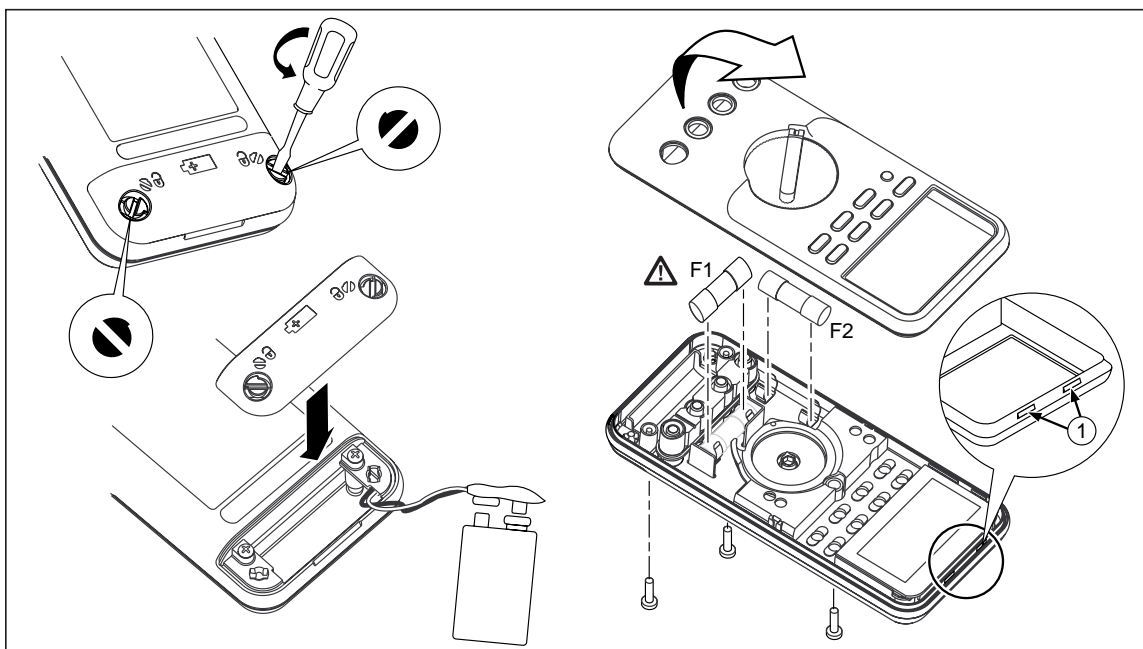

Figure 2. Battery and Fuse Replacement

### Reassembling the Meter Case

To reassemble the Meter Case, do the following:

1. Verify that the rotary switch and circuit board switch are in the **OFF** position, and that the gasket remains secured to the case bottom.
2. Place the case top on the case bottom, ensuring that the gasket is properly seated and the case halves snap together above the LCD end. (See Figure 2.)
3. Reinstall the three screws and the battery door.
4. Secure the battery door by turning the screw 1/4-turn clockwise.
5. Go to “Performance Tests” later in this document, and perform the procedures described.

### Replacing the Battery

The Meter is powered by a single 9 V battery (NEDA 1604, 6F22, or 006P).

To replace the battery, refer to Figure 2 and do the following:

1. Turn the rotary switch to OFF and remove the test leads from the terminals.
2. Remove the battery door by using a flat-blade screwdriver to turn the battery door screws 1/4-turn counterclockwise.
3. Remove the battery and replace it with a new one. Dress the battery leads so that they will not be pinched between the battery door and case bottom.
4. Replace the battery door and secure the door by turning the screws 1/4-turn clockwise.

### Testing Fuses (F1 and F2)

To test the internal fuses of the Meter, refer to Figure 3 and do the following:

1. Turn the rotary selector switch to the  $\Omega$  position.
2. To test F2, plug a test lead into the  $V \Omega$  input terminal, and touch the probe to the **A** input terminal. (Because the receptacles of the input terminals contain split contacts, be sure that you touch the probe to the half of the receptacle contact that is nearest the LCD.)

The display should indicate between  $00.0 \Omega$  and  $00.5 \Omega$ .

If the display reads **OL** (overload), replace the fuse and test again. If the display reads any other value, further servicing is required.

3. To test F1, move the probe from the **A** input terminal to the **mA  $\mu$ A** input terminal.

The display should read between  $0.995 \text{ k}\Omega$  and  $1.005 \text{ k}\Omega$ .

If the display reads a high resistance or **OL** (overload), replace the fuse and test again. If the display reads any other value, further servicing is required.

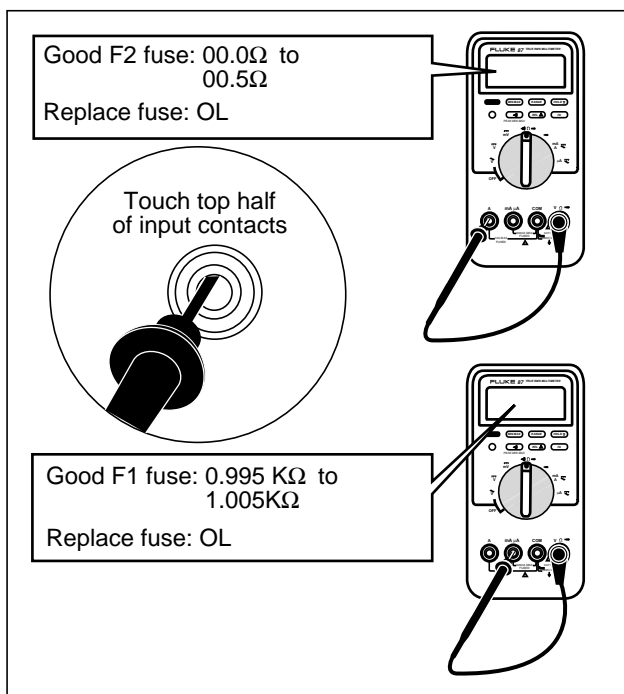

Figure 3. Testing the Current Input Fuses

IY5f.eps

## **Replacing Fuses**

### **⚠ Warning**

**To avoid electrical shock, remove the test leads and any input signals before replacing the battery or fuses. To prevent damage or injury, INSTALL ONLY quick acting fuses with the following Amp/Volt current interrupt ratings:**

**F1 Fuse: 0.440 A, 1000 V, FAST. Minimum interrupt rating 10,000 A**

**F2 Fuse: 11 A, 1000 V, FAST. Minimum interrupt rating 17,000 A**

To replace the Meter's fuses, refer to Figure 2 and do the following:

1. Turn the rotary switch to **OFF** and remove the test leads from the terminals
2. Remove the battery door by using a flat-blade screwdriver to turn the battery door screws 1/4-turn counterclockwise.
3. Remove the three Phillips-head screws from the case bottom and turn the case over.
4. Gently lift the input terminal-end of the case top to separate the two halves of the case.
5. Remove the fuse by gently prying one end loose, then sliding the fuse out of its bracket.
6. Replace the fuse only with one specified above.
7. Verify that the rotary switch and the circuit board switch are in the **OFF** position.
8. Place the case top on the case bottom, ensuring that the gasket is properly seated and the case halves snap together above the LCD end. (See Figure 2.)
9. Reinsert the three case bottom screws and the battery door.

## **Cleaning**

### **⚠ Warning**

**To avoid electrical shock or damage to the Meter, never allow water inside the case. To avoid damaging the Meter's housing, never apply solvents to the Meter.**

If the Meter requires cleaning, wipe it down with a cloth that is lightly dampened with water or a mild detergent. Do not use aromatic hydrocarbons, chlorinated solvents, or methanol-based fluids when wiping down the Meter.

## **Input Terminals**

Water, dirt, or other contamination in the **A** or **mA**  $\mu$ **A** input terminals may activate the Input Alert beeper even though test leads are not inserted. Such contamination might be dislodged by turning the Meter over and, with all test leads removed, gently tapping on the case.

To clean the input terminals more effectively, do the following:

1. Turn the Meter off and remove all test leads from the terminals.
2. Use a clean swab in each of the four terminals to dislodge and clean out the contamination.

3. Moisten a new swab with a cleaning and oiling agent (such as WD40). Work this swab around in each of the four terminals.

The oiling agent insulates the terminals from moisture-related shorting and ensures against false Input Alerts.

### **Rotary Switch**

To clean the rotary switch potentiometer, do the following:

1. Remove the circuit board assembly as described earlier under “Removing and Reinserting the Circuit Board Assembly”.
2. From the back of the circuit board assembly, push the switch shaft in, and remove the polymer thick film (ptf) contact assembly.
3. Clean the ptf contact assembly and the potentiometer on the circuit assembly with alcohol. Blow these parts dry with clean, dry air.
4. Using a Q-tip, apply a thin film of W. F. Nye Gel Lubricant, #813S (Fluke PN 926084), to the entire surface of the ptf pattern and the hole in the center of the pattern. It is important that the grease be applied in a film of consistent thickness such that grease does not accumulate on the ptf wiper contacts. Remove excess grease with a dry Q-tip. No portion of the ptf pattern should be left unlubricated.
5. Push and secure the ptf contact assembly back on to the switch shaft.
6. Reassemble the circuit assembly, the shields, and case halves as described earlier under “Reassembling the Meter Case”.
7. Perform the procedures under “Performance Tests”.

## **Performance Tests**

The following performance tests verify the complete operability of the Meter and check the accuracy of each Meter function against the Meter’s specifications.

Accuracy specifications are valid for a period of one year after calibration, when measured at an operating temperature of 18°C to 28°C and at a maximum of 90 % relative humidity.

To perform the following tests, it is not necessary to open the case; no adjustments are necessary. Merely make the required connections, apply the designated inputs, and determine if the reading on the Meter display falls within the acceptable range indicated.

*If the Meter fails any of these tests, it needs calibration adjustment or repair.*

### **A Basic Operability Test**

To check the basic operability of an 80 Series III Multimeter, do the following:

1. Turn the rotary switch to  $\Omega$  and connect a test lead from the  $V \Omega \rightarrow$  to the **mA**  $\mu$ **A** inputs. (If you are using a test probe, touch the half of the input contact nearest the LCD.)

The display should read 1.000 k $\Omega$   $\pm$  5 digits.

2. With the rotary switch still at  $\Omega$ , test the A input fuse (11 A) by inserting the plug end of the test lead into the **A** input.

The beeper emits an Input Alert tone if the fuse is good.

- Then test the mA  $\mu$ A input fuse (0.440 A) by inserting the plug end of the test lead into the **mA  $\mu$ A** input.

The beeper emits an Input Alert tone if the fuse is good.

If the Meter fails to operate properly:

- Check the battery and fuses and replace as needed.
- Verify that you are operating the Meter correctly by reviewing the operating instructions found in the *Users Manual*.

To complete a comprehensive performance test and verify the accuracy of each Meter function and operation, perform the remainder of the tests under “Performance Tests”.

### Testing the Display

Turn the Meter on and press any push-button to hold the Meter in Display Test mode.

Compare the display with the appropriate example in Figure 4.

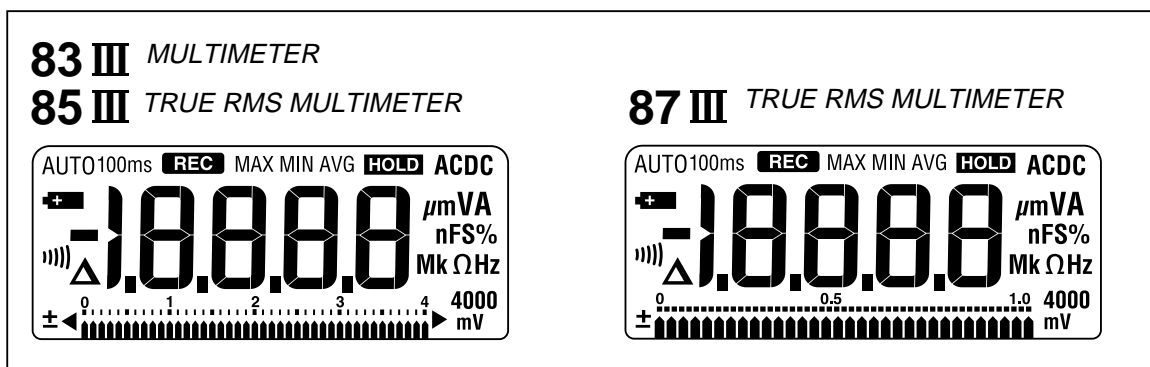

Figure 4. Display Test

ek9f.eps

### Testing the Rotary Switch

This test verifies the operation of the rotary switch function selector.

The function selector circuit relies on the interface between a ptf region on the circuit assembly and a rotating contact assembly on the switch shaft. The rotary switch test exercises this interface by checking the various range codes and displaying their representative numbers.

To perform the rotary switch test, do the following:

1. Hold down **(RANGE)** while turning the rotary switch from **OFF** to **V̄**.
2. Release **(RANGE)**.

Normal Meter functions are now disabled, and a number appears in the display.

3. Compare the number on the display with the number for the V dc (**V̄**) function in Table 3.

The display should read -32 ( $\pm 12$ ).

4. Repeat this test for each position on the rotary switch.
5. To exit the rotary switch test mode, turn the rotary switch to **OFF**, then back to any function selection.

**Table 3. Rotary Switch Test**

Rotary Switch Position	Display ( $\pm 12$ )	Rotary Switch Position	Display ( $\pm 12$ )
OFF	N/A	Continuity/Ohms	-96
V ac	0	Diode test	-128
V dc	-32	mA/A	-160
mV dc	-64	$\mu$ A	-192

**Testing the AC Voltage Function**

To verify accuracy in the ac voltage ranges, do the following:

1. Connect the Calibrator to the  $V \Omega \rightarrow \text{---}$  and **COM** inputs on the Meter.
2. Set the Calibrator for the voltage and frequency called for in step 1 of Table 4.
3. Compare the reading on the Meter display with the display reading for your 80 Series III model (83, 85, or 87) shown in Table 4.

If the display reading falls outside of the range shown in Table 4, the Meter does not meet specification.

4. Repeat this procedure for steps 2 through 17 of Table 4.

**Table 4. AC Voltage Test**

Step	Input		Display Reading	
	Voltage	Frequency	83 Series III	85/87 Series III
1	350.0 mV	60 Hz	347.8 to 352.2	347.1 to 352.9
2	350.0 mV	1 kHz	346.1 to 353.9	346.1 to 353.9
3	350.0 mV	5 kHz	342.6 to 357.4	342.6 to 357.4
4	350.0 mV	20 kHz	NA	341.0 to 359.0
5	3.500 V	60 Hz	3.480 to 3.520	3.473 to 3.527
6	3.500 V	1 kHz	3.461 to 3.539	3.461 to 3.539
7	3.500 V	5 kHz	3.426 to 3.574	3.426 to 3.574
8	3.500 V	20 kHz	NA	3.410 to 3.590
9	35.00 V	60 Hz	34.80 to 35.20	34.73 to 35.27
10	35.00 V	1 kHz	34.61 to 35.39	34.61 to 35.39
11	35.00 V	5 kHz	34.26 to 35.74	34.26 to 35.74
12	35.00 V	20 kHz	NA	34.10 to 35.90
13	350.0 V	60 Hz	348.0 to 352.0	347.3 to 352.7
14	350.0 V	1 kHz	346.1 to 353.9	346.1 to 353.9
15	350.0 V	2.5 kHz	342.6 to 357.4	342.6 to 357.4
16	900V	60 Hz	893 to 907	892 to 908
17	900 V	1 kHz	887 to 913	887 to 913



### Testing the Frequency Function

To verify the accuracy of the Meter's frequency function, do the following:

1. Connect the Calibrator to the  $V \Omega \rightarrow \text{+}$  and **COM** inputs on the Meter.

*Note*

*The accuracy of the Calibrator's frequency function must be appropriate for the specified accuracy of the Meter.*

2. With the Meter in the 400 mV ac range, press  to enter the Frequency Counter mode.
3. Set the Function Generator for the sine wave voltage and frequency called for in step 1 of Table 5.
4. Compare the reading on the Meter display with the display reading shown in Table 5.
5. If the display reading falls outside of the range shown in Table 5, the Meter does not meet specification.
6. Set the Function Generator for the sine wave voltage and frequency called for in step 2 of Table 5 and compare the reading on the Meter display with the display reading shown in Table 5.

**Table 5. Frequency Test**

Step	Sine Wave Input		Display Reading 83/85/87
	Voltage	Frequency	
1	150 mV rms	19.000 kHz	18.998 to 19.002
2	150 mV rms	190.00 kHz	189.98 to 190.02

### Testing the Frequency Sensitivity and Trigger Level

To verify the counter sensitivity and trigger levels for all frequency modes and ranges, do the following. (For any function and range, the sensitivity and trigger level is the same in both frequency and duty cycle modes.)

1. Connect the Calibrator to the  $V \Omega \rightarrow \text{+}$  and **COM** inputs on the Meter.
2. Put the Meter in the 4 V ac range, and press .
3. Apply the input from step 1 of Table 6, and compare the reading on the Meter display with the display reading in Table 6.
4. Put the Meter in the 4 V dc range, and press .
5. Apply the input from steps 2 and 3 of Table 6, and compare the reading on the Meter display with the display reading in Table 6.

If the display reading falls outside of the range shown in Table 6, the Meter does not meet specification.

6. On the Meter, press  to enter the 40 V dc range.
7. Apply the input for steps 4 and 5 of Table 6, compare the reading on the Meter display with the display reading in Table 6.

**Table 6. Frequency Counter Sensitivity and Trigger Level Tests**

Step	Range	Amplitude (RMS)	Frequency	Display Reading
1	4 V ac	300 mV ac	1 kHz	999.8 - 1000.2
2	4 V dc	1.7 V ac	1 kHz	999.8 - 1000.2
3	4 V dc	1.0 V ac	1 kHz	000.0
4	40 V dc	6.0 V ac	1 kHz	999.8 - 1000.2
5	40 V dc	2.0 V ac	1 kHz	000.0

**Testing DC Voltage**

To verify accuracy of the dc voltage function, do the following. (A separate performance test procedure for mV dc is provided later in this section).

1. Connect the Calibrator to the  $V \Omega \rightarrow \text{---}$  and **COM** inputs on the Meter.
2. Turn the rotary switch to  $\bar{V}$ .
3. Apply the input from step 1 of Table 7 for your model 80 Series III.
4. Compare the reading on the Meter display with the display reading in Table 7.

If the display reading falls outside of the range shown in Table 7, the Meter does not meet specification.

5. Repeat steps 3 and 4 for the remaining inputs shown in Table 7.

**Table 7. DC Voltage Test**

Step	DC Input Voltage	Display Reading		
		83 III	85 III	87 III
1	3.500 V	3.495 to 3.505	3.496 to 3.504	3.497 to 3.503
2	35.00 V	34.95 to 35.05	34.96 to 35.04	34.97 to 35.03
3	-35.00 V	-34.95 to -35.05	-34.96 to -35.04	-34.97 to -35.03
4	350.0 V	349.5 to 350.5	349.6 to 350.4	349.7 to 350.3
5	1000 V	998 to 1002	998 to 1002	998 to 1002

**Testing the PEAK MIN MAX Function (Model 87 only)**

To check minimum/maximum (**MIN MAX**) feature of the Model 87.

1. Connect the Calibrator to the  $V \Omega \rightarrow \text{---}$  and **COM** inputs on the Meter.
2. Apply 2.0 V ac at 60 Hz (step 1, Table 8) from the Calibrator to the  $V \Omega \rightarrow \text{---}$  and **COM** inputs of the Meter.
3. Turn the rotary switch to  $\bar{V}$  (dc volts for dc-coupling of the input) or  $\tilde{V}$  (ac volts for capacitive-coupling of the input).

*Note*

*The rms converter is not used in Peak mode. The digital display represents the actual peak value of the input.*

4. Press **(MIN MAX)**.
5. Press the **( )** (beeper) to enter the **PEAK MIN MAX** mode and begin displaying maximum values.

6. Compare the reading on the Meter display to the display reading for step 1 in Table 8.  
If the display reading falls outside of the range shown in Table 8, the Meter does not meet specification.
7. Press **(MIN MAX)** to begin displaying minimum values.
8. Compare the reading on the Meter display to the display reading for step 2 in Table 8.

**Table 8. Peak MIN MAX Test**

Step	AC Input		Display Reading		
	Voltage	Frequency	83 III	85 III	87 III
1	2.0 V	60 Hz	N/A	N/A	2.705 to 2.951
2	2.0 V	60 Hz	N/A	N/A	-2.705 to -2.951

### **Testing the mV DC Function**

To test the accuracy of the mV dc function, do the following:

1. Connect the Calibrator to the **V Ω →|+** and **COM** inputs on the Meter.
2. Turn the rotary switch to **mV<sup>DC</sup>**.
3. Apply 350.0 mV.
4. Compare the reading on the Meter display to the display reading for your Model shown below.
  - Model 83 III    348.8 to 351.2
  - Model 85 III    349.5 to 350.5
  - Model 87 III    349.5 to 350.5

If the display reading falls outside of the range shown, the Meter does not meet specification.

### **Testing the Resistance Function**

To verify the accuracy of the resistance function, do the following:

1. Connect the Calibrator to **V Ω →|+** and **COM** on the Meter.
2. Turn the rotary switch to **Ω**.
3. Apply the inputs for steps 1-5 in Table 9.  
Compare the Meter display readings to the display readings for your Model of Meter.
4. Press **(RANGE)** on the Meter to enter the 40-nanosiemen range used for conductance tests of high resistances. Then proceed with step 6 of Table 9.



**Table 9. Ohms Tests**

Step	Resistance	Display Reading		
		83 III	85 III	87 III
1	short	To zero resistance in leads, short probes and press <b>REL Δ</b> .		
2	190.0Ω	189.0 to 191.0	189.4 to 190.6	189.4 to 190.6
3	19.00 kΩ	18.91 to 19.09	18.95 to 19.05	18.95 to 19.05
4	1.900 MΩ	1.886 to 1.914	1.888 to 1.912	1.888 to 1.912
5	19.00 MΩ	18.78 to 19.22	18.78 to 19.22	18.78 to 19.22
6	100.0 MΩ	9.80 to 10.20 nS	9.80 to 10.20 nS	9.80 to 10.20 nS

**Testing the Capacitance Function**

The Meter measures capacitance by charging the capacitor with a known direct current, measuring the resultant voltage, and calculating the capacitance. If the same capacitance is measured on an impedance bridge, a different reading may result. This variance is likely to be greater at higher frequencies.

To verify the accuracy of the capacitance measuring function, do the following:

1. Connect the Calibrator to the **V Ω**  and **COM** inputs on the Meter.
2. For steps 1 through 3 in Table 10:
  - a. Turn the rotary switch to .
  - b. Press the blue button.
  - c. Connect the test leads to the capacitor.
  - d. For each input, compare the readings on the Meter display to display readings for your Model of Meter.

The Meter selects the proper range automatically. Each measurement takes about one second per range.



3. Before applying the input for step 4 of Table 10, disconnect the test leads from the calibrator and press the **REL Δ** to zero the display (automatically subtracts the residual Meter and test lead capacitance). Reconnect the test leads to the calibrator and apply the input for step 4 of Table 10. Note that the relative mode puts the Meter into manual Range.

**Table 10. Capacitance Tests**

Step	Capacitance	Display Reading		
		83 III	85 III	87 III
1	1.0 μF	0.95 to 1.05	0.95 to 1.05	0.95 to 1.05
2	0.470 μF	0.462 to 0.478	0.462 to 0.478	0.462 to 0.478
3	0.0470 μF	0.0462 to 0.0478	0.0462 to 0.0478	0.0462 to 0.0478
4	4.70 nF	4.62 to 4.78	4.62 to 4.78	4.62 to 4.78

**Checking the Diode Test Function**

To check the diode test function, do the following:

1. Connect the Calibrator to the **V Ω**  and **COM** inputs on the Meter.
2. Turn the rotary switch to .

*Note*

*If you use a Fluke 5100 Series Calibrator, activate the 50  $\Omega$  divider override.*

3. Apply 3.000 V.  
The Meter display should read 3.000 V dc +/- 0.061 V dc.

**Testing the Milliamp (mA) Function**

To verify the accuracy of AC and DC current measurement functions, do the following:

1. Connect the Calibrator to the **mA**  $\mu$ A and **COM** inputs on the Meter.
2. Turn the rotary switch to **mA/A**  $\approx$ .  
The Meter enters the DC measurement function
3. Apply the inputs in steps 1 and 2 in Table 11.
4. For each input, compare the readings on the Meter display to the display readings for your Model of Meter.
5. Press the blue button on the Meter to toggle to AC measurement function.
6. Apply the inputs in steps 3 through 6 in Table 11.
7. For each input, compare the readings on the Meter display to the display readings for your Model of Meter.

**Table 11. mA Tests**

Step	DC Current		Display Reading		
			83 III	85 III	87 III
1	35.00 mA		34.82 to 35.18	34.89 to 35.11	34.89 to 35.11
2	350.0 mA		348.4 to 351.6	349.1 to 350.9	349.1 to 350.9
	AC Current	Frequency	83 III	85 III	87 III
3	35.00 mA	60 Hz	34.56 to 35.44	34.63 to 35.37	34.63 to 35.37
4	35.00 mA	1.0 kHz	34.56 to 35.44	34.63 to 35.37	34.63 to 35.37
5	350.0 mA	60 Hz	345.6 to 354.4	346.3 to 353.7	346.3 to 353.7
6	350.0 mA	1.0 kHz	345.6 to 354.4	346.3 to 353.7	346.3 to 353.7

**Testing the Microamp ( $\mu$ A) Function**

To verify the accuracy of the microamp ( $\mu$ A) measurement function, do the following:

1. Connect the Calibrator to the **mA**  $\mu$ A and **COM** inputs on the Meter.
2. Turn the rotary switch to  **$\mu$ A**  $\approx$ .  
The Meter enters the DC measurement function.
3. Apply the inputs in steps 1 and 2 of Table 12.
4. For each input, compare the readings on the Meter display to the display readings for your Model of Meter.
5. Press the blue button on the Meter to toggle to the AC measurement function.
6. Apply the inputs in steps 3 and 6 of Table 12.

- For each input, compare the readings on the Meter display to the display readings for your Model of Meter.

**Table 12.  $\mu$ A Tests**

Step	DC Current		Display Reading		
			83 III	85 III	87 III
1	350.0 $\mu$ A		348.2 to 351.8	348.9 to 351.1	348.9 to 351.1
2	3500 $\mu$ A		3484 to 3516	3491 to 3509	3491 to 3509
	AC Current	Frequency	83 III	85 III	87 III
3	350.0 $\mu$ A	60 Hz	345.6 to 354.4	346.3 to 353.7	346.3 to 353.7
4	350.0 $\mu$ A	1.0 kHz	345.6 to 354.4	346.3 to 353.7	346.3 to 353.7
5	3500 $\mu$ A	60 Hz	3456 to 3544	3463 to 3537	3463 to 3537
6	3500 $\mu$ A	1.0 kHz	3456 to 3544	3463 to 3537	3463 to 3537

**Testing the Amp (A) Function**

To verify the accuracy in the ampere (**A**) measurement function, do the following:

- If necessary, set the Calibrator output to 0.
  - Connect the Calibrator to the **A** and **COM** inputs of the Meter.
  - Turn the rotary switch to **mA/A**.
- The Meter enters the DC amp measurement function.
- Apply the inputs in steps 1 and 2 in Table 13.
  - For each input, compare the readings on the Meter display to the display readings for your Model of Meter.
  - Set the calibrator output to 0.
  - Press the blue button on the Meter to toggle to the AC amp measurement function.
  - Apply the inputs in steps 3 through 6 in Table 13.
  - For each input, compare the readings on the Meter display to the display readings for your Model of Meter.

**Table 13. Current Tests**

Step	DC Current		Display Reading		
			83 III	85 III	87 III
1	3500 mA		3482 to 3518	3489 to 3511	3489 to 3511
2	10.00A		9.94 to 10.06	9.96 to 10.04	9.96 to 10.04
	AC Current	Frequency	83 III	85 III	87 III
3	3500 mA	60 Hz	3456 to 3544	3463 to 3537	3463 to 3537
4	3500 mA	1.0 kHz	3456 to 3544	3463 to 3537	3463 to 3537
5	10.00 A	60 Hz	9.86 to 10.14	9.88 to 10.12	9.88 to 10.12
6	10.00 A	1.0 kHz	9.86 to 10.14	9.88 to 10.12	9.88 to 10.12

## Calibration

Calibrate the Meter once a year to ensure that it performs according to specifications.

Calibration adjustment points are identified in Figure 5.

There is a slightly different calibration procedure for each model of the 80 Series III. Be sure to follow the correct procedure for your unit.

### Calibrating the Model 85 and 87 III

To calibrate the Meter, perform the following procedure:

1. Set the Calibrator for 0 V dc.
2. Put the Model 85 III or 87 III in the  $\bar{V}$  function.
3. Connect the Calibrator to the  $V \Omega \rightarrow \leftarrow$  and **COM** inputs on the Meter.
4. Output 3.500 V dc from the Calibrator.  
Adjust R21 to obtain a Meter display reading of  $3.500 \pm 0.001$ .
5. Put the Model 85 III or 87 III in the  $\tilde{V}$  function.
6. Output 3.513 V at 50 Hz from the Calibrator.  
Adjust R34 to obtain a Meter display reading  $3.500 \pm 0.002$ .

*Note*

*The disparity between an input 3.513 and a display reading of 3.500 is due to compensation for the RMS converter linearity.*

7. Output 100 V at 20 kHz from the Calibrator.  
Adjust C37 to obtain a Meter display reading of  $100.0 \pm 0.2$ .
8. Output 3.500 V at 10 kHz from the Calibrator.  
Adjust C2 to obtain a Meter display reading of  $3.500 \pm 0.004$ .
9. Output 35.00 V at 10 kHz from the Calibrator.  
Adjust C3 to obtain a Meter display reading of  $35.00 \pm 0.04$ .

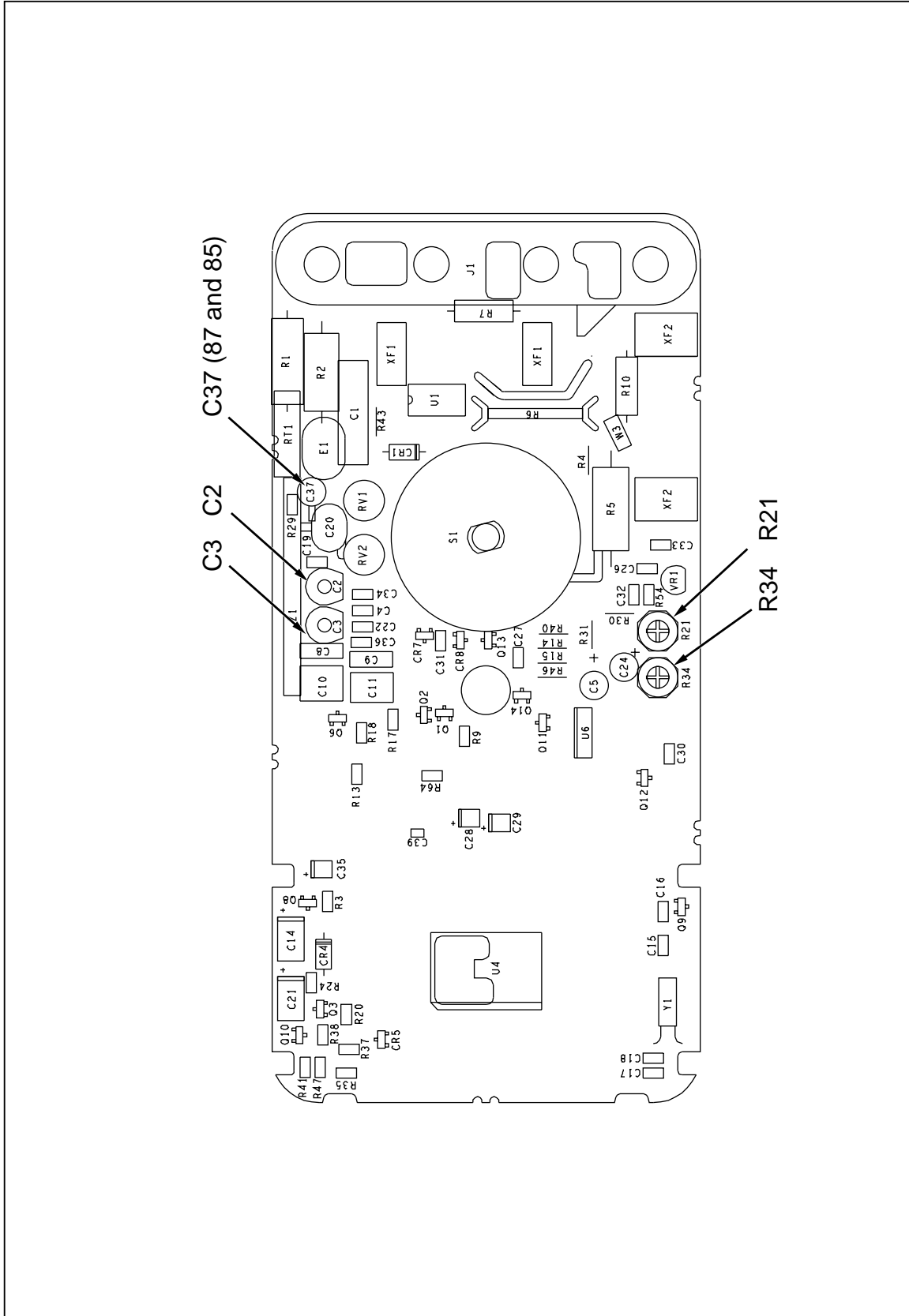

Figure 5. Calibration Adjustment Points

ek6f.eps



### Calibrating the Model 83 III

To calibrate the Model 83 III, perform the following procedure:

1. Set the Calibrator for 0 V dc.
2. Put the Model 83 III in the  $\bar{V}$  function.
3. Connect the source to the  $V \Omega \rightarrow$  and **COM** inputs on the Meter.
4. Output 3.500 V dc from the Calibrator.  
Adjust R21 to obtain a Meter display reading of 3.500 +/-0.001.
5. Put the Meter in to the  $\tilde{V}$  function.
6. Output 3.500 V at 100 Hz from the Calibrator.  
Adjust R34 to obtain a Meter display reading of 3.500 ±0.002.
7. Output 100 V at 20 kHz from the calibrator. Adjust C37 to obtain a meter display ready of 100.0 ± 0.2.
8. Output 3.500 V at 10 kHz from the Calibrator.  
Adjust C2 to obtain a Meter display reading of 3.500 ±0.004.
9. Output 35.00 V at 10 kHz.  
Adjust C3 to obtain a Meter display reading of 35.00 ±0.04.

### Parts and Accessories

Replacement parts and accessories are listed in Tables 14, 15 and shown in Figure 6.

**Table 14. Replacement Parts**

Item	Description	Fluke Part No	Qty
BT1	Battery, 9 V	614487	1
F1 $\Delta$	Fuse, 0.440 A, 1000 V, FAST	943121	1
F2 $\Delta$	Fuse, 11 A, 1000 V, FAST	803293	1
H1	Screw, Case	832246	3
H5,H6	Fastener, Access Door	948609	
MP1	Foot, Non-Skid	824466	2
MP2	O-Ring, Input Receptacle	831933	1
MP85	Case Top (pad xfer), w/window	616885 (83 III ,85 III) 616877 (87 III)	
MP86	Btm Case w/gasket 8x-w/ce/csa	616703	
MP92	Battery Door-CE update	609930	
TM1	CD-ROM (contains Users Manuals)	1611720	1
TM2	Getting Started Manual	1611712	1
TM3	Quick Reference Guide, Fluke 80 Series III	688168	1
TM4	Service Information Manual	688645	Optional
Backlight	Backlight, White	609922	
LCD	LCD, 4.5 digit, bar graph, multiplexed	686634 (83 III, 85 III) 686391 (87 III)	

$\Delta$ To ensure safety, use exact replacement only.

**Table 15. Accessories\***

Item	Description	Fluke Part Number	Quantity
TL20	Industrial Test Lead Set (Optional)	TL20	—
AC70A	Alligator Clips for use with TL75 test lead set	AC70A	1
TL75	Test Lead Set	TL75	1
TL24	Test Lead Set, Heat-Resistant Silicone	TL24	—
TP1	Test Probes, Flat Blade, Slim Reach	TP1	—
TP4	Test Probes, 4 mm diameter, Slim Reach	TP4	—
AC20	Safety Grip, Wide-Jaw Alligator Clips	AC20	—
C81Y	Holster, Yellow	C81Y	1
C81G	Holster, Gray (Optional)	C81G	—
C25	Carrying Case, Soft (Optional)	C25	—

\* Fluke accessories are available from your authorized Fluke distributor.

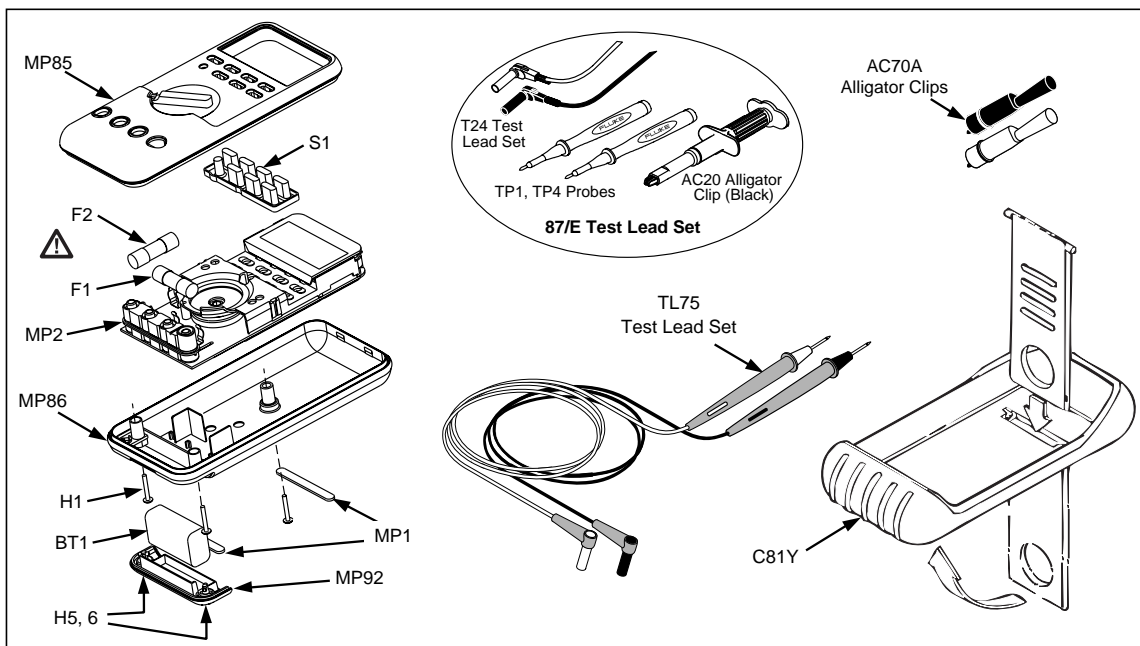

IY11F.EPS

**Figure 6. Replaceable Parts**