



Data Sheet

Fluke ScopeMeter Series IIB selection guide

[Fluke 92B Specs](#)
 Provided by www.AAATesters.com

Figure 1 Description

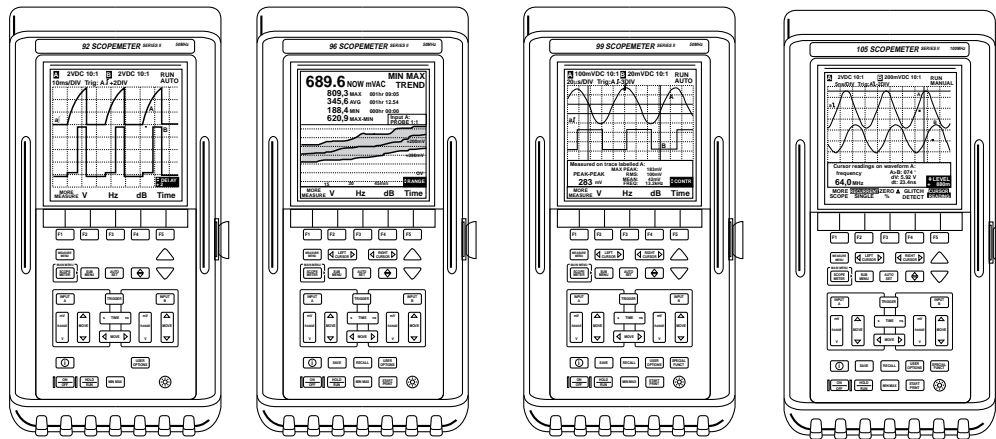

Fluke 92B
RS stock no. 214-5098
Fluke 96B
RS stock no. 214-5105
Fluke 99B
RS stock no. 214-5111
Fluke 105B
RS stock no. 214-5127

Introduction

The Fluke ScopeMeter test tools (93, 95 and 97) were first introduced in 1991 and revolutionised field troubleshooting and service. For the first time technicians could carry a powerful oscilloscope, a full-featured digital multimeter and a 4-digit frequency counter all in one portable, handheld instrument.

The new ScopeMeter IIB with ultra bright high contrast display uses sophisticated technology to provide 25 MSPS acquisition rate and 100MHz bandwidth for the ScopeMeter 99B and 105B and 60MHz bandwidth for the rest of the series. The series IIB features random repetitive sampling rates of 5 Gigasamples/sec for the 99B and 105B, 2.5 Gigasamples/sec for the 92B and 96B.

Video triggering modes are available on all series IIB to provide both field and line triggering with a line counter and support of the major video standards.

All the new Fluke Series IIB ScopeMeter models give one button access to automatic measurements. From the Measure menu simply select the measurement you want to make and ScopeMeter Series IIB automatically configures itself for that measurement. As the selection is being chosen an 'on-line' assistance message appears in the centre of the screen to let you know something about the selected choice. The information icon "i" also appears to offer full screen detail about the hook up and what the measurement will provide.

Once the configuration is complete and the signal is displayed, Continuous Autoset takes over and tracks any change to the input signal and makes any necessary adjustments to maintain a measurable waveform display. Simply stated it "locks" on the signal and 'tracks' any changes in that signal.

Figure 2 Screen showing "i" information

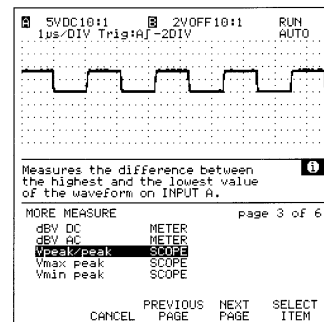
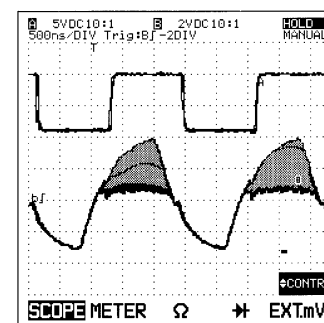

Figure 3 Screen showing dual channel oscilloscope display and persistence on channel B waveform



Product features in greater depth

Memory/storage

The extra large memory on all models has plenty of room to store setups, waveforms and screens for future reference, printing or uploading to a PC for analysis. The models 105B, 99B and 96B allow waveforms to be printed directly via the optically isolated RS-232 serial interface (RS stock no. 205-738) to Epson FX and HP compatible printers. The Fluke 99B and 105B also allow the transfer of waveforms and measurement data to and from a PC, as well as remote control. All four models allow screen image transfers to a PC for printing or use in documents.

The large non-volatile memory allows the Fluke 99B and 105B to save up to 40 set-ups, 20 waveforms and 10 screens; the Fluke 96B has storage for 5 screens, 10 waveforms and 20 setups.

Video triggering

The series IIB has video triggering modes including TV Field 1, Field 2, Line or selectable line number allowing you to lock onto video signals. The major interlaced video standards are supported including PAL, PAL/M, NTSC & SECAM and non interlaced video with line frequencies between 14kHz and 65kHz.

Portable and rugged

Whether troubleshooting electronic, machine control, electrical, telecommunications or computer circuits, ScopeMeter Series IIB makes it easy to get the right answers where ever and when ever you need them. Sealed against the elements, protected by a shock resistant holster and battery or line powered.

The ScopeMeter has been designed and tested in accordance with IEC publication 1010. Safety Requirements for Electrical Equipment for measurement, control and laboratory use.

“Automatic” setup - easy to use controls

The ScopeMeter Series IIB interface is designed around the most common circuit measurements likely to be made. The Automatic Measurements with Continuous Autoset from the Direct Access menu saves time and simplifies set up. Even though this new environment of automatic measurements saves time, both the scope and meter can be operated manually to meet any additional analysis needs the user may have.

Easy to use key layout is a key feature, the key layout below shows the functionality of the Fluke 99B key design.

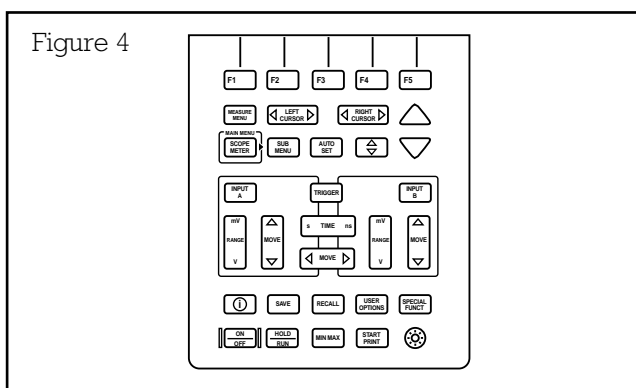

Figure 4

Direct Access Measure menu for instant setups

One touch to select the Measure menu gives you direct access to a pop-up menu of more than 30 measurements as well as 4 short lists for those rush jobs. Simply select the measurement and Series IIB automatically sets itself up to do the job. It's a lot quicker for experienced scope users, and easier for users who know the measurement they want but don't quite know how to set up the instrument.

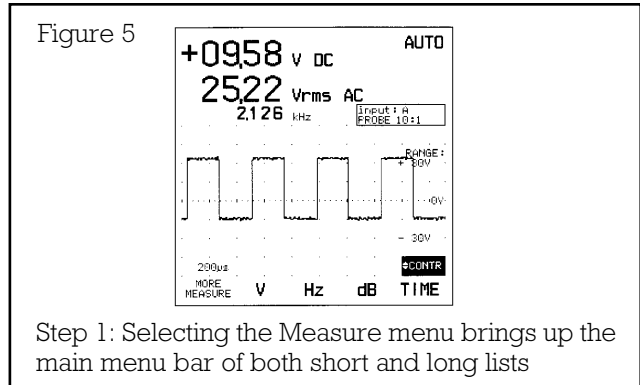

Figure 5

Step 1: Selecting the Measure menu brings up the main menu bar of both short and long lists

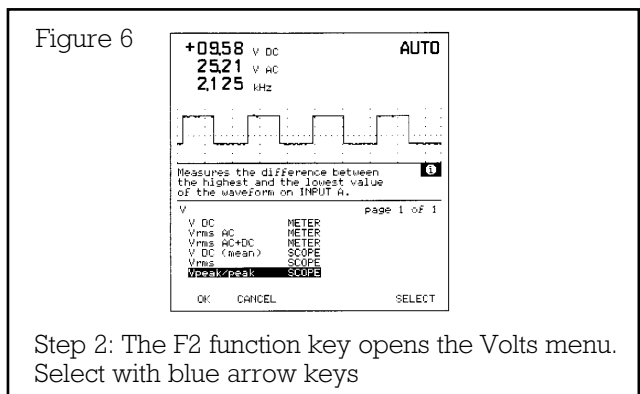

Figure 6

Step 2: The F2 function key opens the Volts menu. Select with blue arrow keys

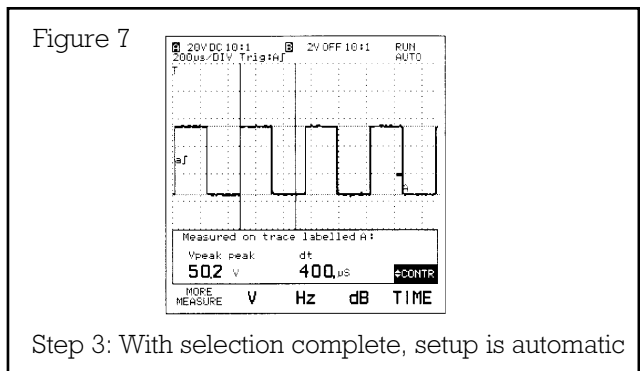

Figure 7

Step 3: With selection complete, setup is automatic

5GS/s, 200 ps random repetitive sampling for better accuracy

Verifying repetitive signals - such as clock pulses, carrier waves, and fast rise time signals - in computing or communications equipment can be difficult because high frequencies are hard to capture. At the higher timebase speeds used to capture these higher frequencies, Fluke ScopeMeter series IIB uses 'random repetitive' sampling - the technique used in larger, higher priced lab scopes. This technique takes one or more samples following multiple triggers from a repetitive signal. The microprocessor in ScopeMeter series IIB arranges all the samples and displays them in order. On the 99B and 105B at the highest timebase speed of 5ns/dv, each division is represented by 25 true samples. That delivers a 200 picosecond time resolution - the equivalent of a sampling rate of 5GS/s.

Min Max TrendPlot™ expands the Meter Min/Max function

Fluke's unique new TrendPlot feature presents changing Min/Max/Avg values in graphic form. The analog-like grayscale, variable persistence display clearly distinguishes between the three measurements to give you an instant read of spikes, sags and transients. TrendPlot is automatically activated with a touch of the Min/Max button and can display, scale and record up to 40 days of signal trend. TrendPlot provides signal detail to pinpoint intermittent problems that are hard to track down otherwise.

Figure 8

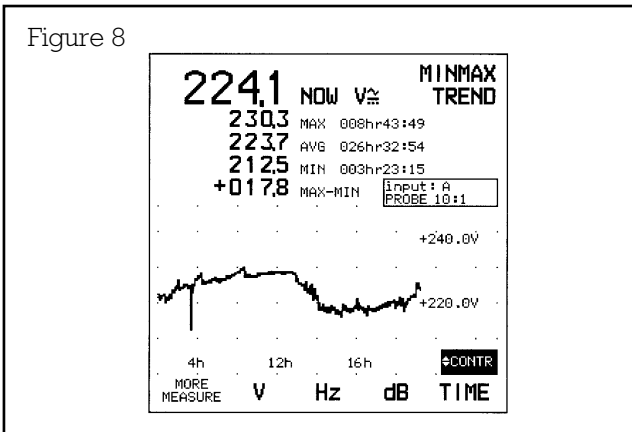

Deep 30K memory

Memory depth is important for capturing events. The more samples storage memory the more accurately you can record and examine long cycles. For single shot events such as switch or relay closure or a power supply startup, all samples must be taken following a single trigger, in one sequence. Samples must be fast enough to capture the fastest detail of the event and memory must be deep enough to store sufficient samples. ScopeMeter IIB models feature 30K memory in ScopeRecord mode to meet this requirement. ScopeRecord shows events as long as 120 scope screens with zoom facility to magnify signal detail.

Information at your finger tip

No matter what function is in use, the on-line information provides instant help. Get instant answers on how to connect for complex measurements, how to use a special function or to better understand what really happens when a function is selected. The best part is, all that information is with you on the job to make your task easier whether you're 40 feet up, 100 miles out, or in the middle of a plant or office building.

Figure 9

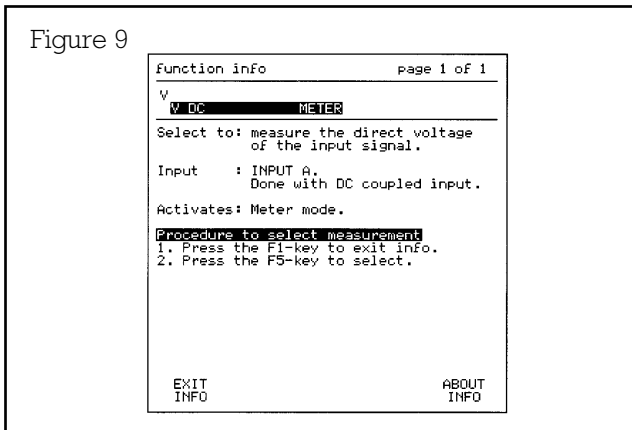

Backlit screen for easy reading

Whether you're working in direct sunlight or in the dark, the bright backlit LCD display on all models presents a clear picture of the situation. Digits and waveforms are presented big and bold enough to be read across the room. And the high reflectivity display provides better visibility in normal light as well.

Figure 10

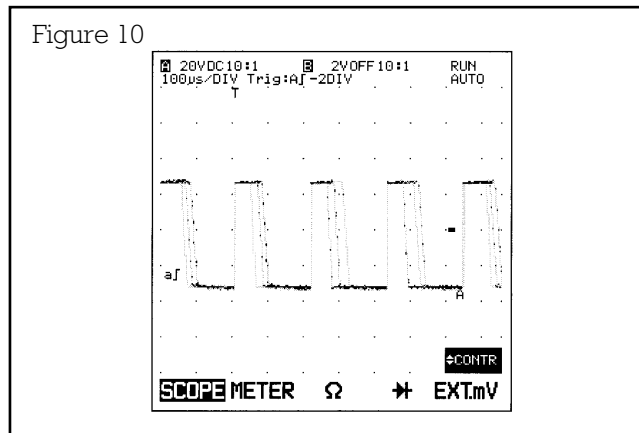

"Analogue-like" display

The display technique employed, produces waveform displays with analogue characteristics. The Min Max Envelope on both inputs reveals signal phenomena not visible before in a portable digital scope, like the variations of AM and FM signals. This feature is invaluable where the need is to see signals which had previously been seen only on an analogue scope.

Add variable persistence to this new technique and you have a portable combined instrument which can replace many analogue scopes. This new technique also adds to the TrendPlot display with grey scale shading of low intensity signals.

Figure 11

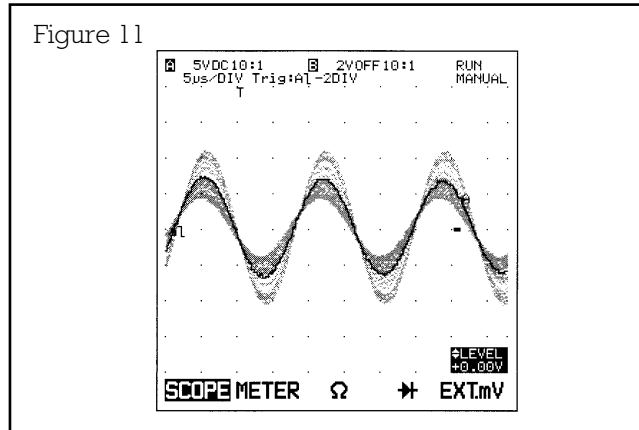

Scope power in the palm of your hand

Despite its compact size, ScopeMeter Series IIB offers performance to meet many demanding applications:

Model 99B & 105B deliver a powerful 100MHz bandwidth. Model 92B and 96B deliver a full 60 MHz bandwidth.

A 25 megasamples per second acquisition rate lets you digitise, view and store single shot phenomena with 40 ns resolution.

The Fluke 92B, 96B, 99B and 105B all feature dual inputs. All models feature true 8 bit vertical resolution, a broad range of triggering functions and a roll mode for low frequency signal analysis.

Advanced calculations for in-depth analysis

Easy-to-use cursors allow waveform tracking while displaying up to five measurements simultaneously in the Models 96B, 99B and 105B. Simply make selections from the pop-up menu or the Measure menu and read the display.

Powerful waveform maths on the Fluke 99B and 105B lets you see hidden waveform data with basic arithmetic functions and waveform integration. In addition, digital filters smooth the waveform to reduce unwanted noise or switching transients to provide a basis for more accurate calculations. Even though the ScopeMeter Series IIB is a lightweight, you can count on it to deliver heavyweight performance wherever you go.

A full featured digital multimeter that stands on its own

Pushing just two buttons on the ScopeMeter Series IIB brings up the full set of meter functions while continuously viewing the new screen-width waveform display.

True precision in a wide range of applications

ScopeMeter Series IIB measures and displays up to four parameters simultaneously with $3^{2/3}$ digit resolution. True rms ac or ac+dc accurately measures the voltage of square waves, pulse trains, noise and other non-sinusoidal waveforms up to 5MHz. This wide bandwidth gives accurate measurements in applications which elude even dedicated ac meters. Fast autoranging automatically selects the range with the greatest accuracy and resolution, or you can set the range manually. With ranges from 100mV to 300V, ScopeMeter Series IIB offers maximum sensitivity for low level signals.

Innovative functions add accuracy and convenience

With Min Max Avg recording you can connect the ScopeMeter Series IIB to record a signal for seconds or days while you continue with other tasks. The highest, lowest and average of all readings are recorded with a time stamp and an audible tone is emitted with new minimum and maximum readings. This is automatically linked with the new TrendPlot allowing you to view Min Max Avg trends in graph form.

For additional hands-free convenience, TouchHold® captures and holds a steady measurement on the display, updating automatically with each new test.

ScopeMeter Series IIB - The list

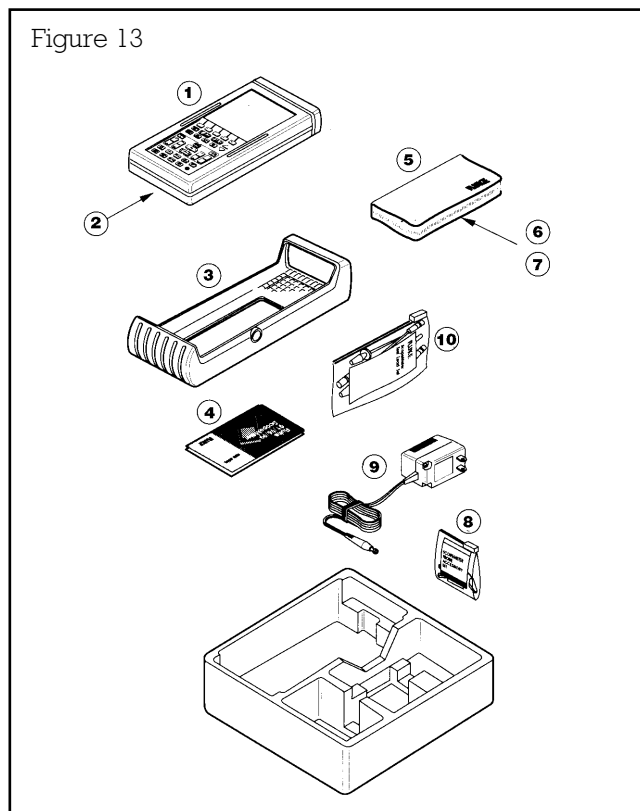

- 1 ScopeMeter test tool
- 2 NiCd battery pack (installed)
- 3 Protective holster
- 4 Users manual
- 5 Accessory case
- 6 Set of two probes
- 7 Set of two industrial alligator clips for scope probes
- 8 Probe accessory set includes:
 - HF adaptors (2 × black)
 - High voltage test pins (red and grey)
 - Probe tip to banana adaptors (red and grey)
 - Mini test hooks (red and grey)
 - Trim screwdrivers (red and grey)
- 9 Power adaptor/battery charger
- 10 Multimeter test lead set includes:
 - Test leads (red and black)
 - Industrial test probes (red and black)
 - Industrial alligator clip (black)
 - Banana adaptors (red and black)

ScopeMeter 105B is supplied with the following additional items:-

- 1 Optical-to-RS232 interface lead
- 2 Flukeview for Windows software on $3\frac{1}{2}$ in floppy disk
- 3 Flukeview users manual
- 4 9 pin male to 25 pin female adaptor
- 5 25 pin male-male gender changer
- 6 Hard carrying case.

Figure 12 Top view of Fluke 99B showing connection system

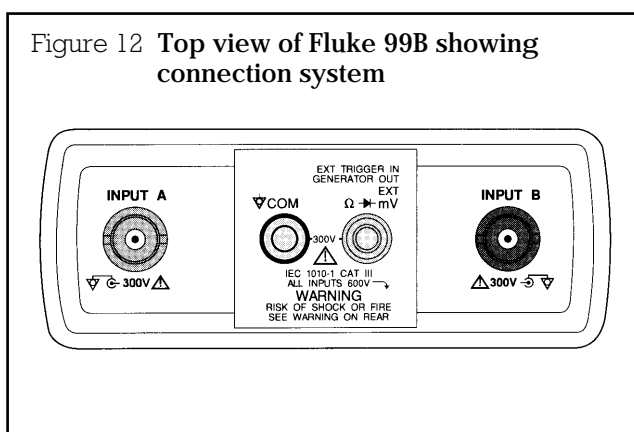

Selection guide

	Fluke 105B	Fluke 99B	Fluke 96B	Fluke 92B
Bandwidth	100MHz dual input	60MHz dual input		
Sample rate (single shot)	25 Megasamples/second			
Measure menu	Direct access to 33 measurements. The best operating mode is automatically selected		Direct access to 18 measurements. The best operating mode is automatically selected	
Continuous autose	Hands-free signal probing. Tracks input signal changes and quickly selects the proper ranges and trigger			
On-line information	Instant On-line information about functions and operation			
Meter MIN MAX TrendPlot	Monitor any meter reading automatically with simultaneous graphs of the MIN, MAX and AVG values from 15 sec/div (120 seconds) to 8 days/div (40 days). Automatic vertical scaling and time compression			
Scope MIN MAX Envelope mode	Monitor waveforms from both inputs and record the MIN MAX excursions with a grayscale envelope			
Multimeter display	3 ² / ₃ digits (>3000 counts). With a full screen width automatic scope waveform			
True RMS Volts	AC or AC+DC up to 600V (1700V Pk-Pk)			
Diode test	Up to 2.8V			
Continuity beeper	Yes			
Time/division	5ns/div to 60 sec/div	10ns/div to 60 sec/div		
Volts/division	1mV/div to 100V/div			
Digital trigger delay	By number of cycles, events, time or zoom mode			
Special multimeter modes	Relative (zero), % scale, smoothing™, change alert™ dBm, dBV, dBW, audio or RF Watts, Hz, pulse width, duty cycle, RPM; measure Amps,			
Scope input scaling	Measure Amps with optional current probes			
Glitch capture	≥40ns			
Scope waveform processing	Analog-like greyscale display and waveform averaging			
Display	High contrast, cold cathode electro luminescent back-lit display			
RS-232 interface via optional adaptor /cable, 600V isolation	Transfer setups waveforms, & screens* or directly print	Directly print or capture screens*	Capture screen*	
Screen memories	10	5		
Waveform memories	20	10		
Set-up memories	40	20		
Oscilloscope cursor readings	15 measurements display 5 simultaneously			
Waveform mathematics	add, subtract multiply, invert, filter or integrate			
Signal generator output	Sinewave or squarewave			
Component tester output	Voltage or current ramp			

* With optional FlukeView PC software and adaptor/cable, supplied complete with the ScopeMeter 105B or as a separate option for the ScopeMeter 99B and 96B.

Interface of ScopeMeter Series II

	105	99	96	92
Screen dump using application software	●	●	●	●
Direct output to printer	●	●	●	
Remote control via computer interface	●	●		

	Measure menu	ScopeMeter main modes				
		Scope	Meter	Ohm	Diode	Ext.mV
Voltage measurements						
Vdc	■		■			■
Vrms ac	■		■			■
Vrms ac+dc	■		■			■
Vrms ac+dc (dc blocked)			■			
Vdc (mean)	■	■				
Vrms	■	■				
dV	■	■				
Vpeak/peak	■	■				
V max. peak	■	■				
V min. peak	■	■				
V at LEFT		■				
V at RIGHT		■				
Accessory (mV)	■		■			
Frequency measurements						
Hz	■	■	■			■
Duty cycle	■		■			■
RPM 1	■		■			■
RPM 2	■		■			■
Power measurements						
dBV dc	■		■			■
dBV ac	■		■			■
dBV ac+dc			■			■
dBV ac+dc (dc blocked)			■			
dBm dc	■		■			■
dBm ac	■		■			■
dBm ac+dc			■			■
dBm ac+dc (dc blocked)			■			
dBW dc	■		■			■
dBW ac	■		■			■
dBW ac+dc			■			■
dBW ac+dc (dc blocked)			■			
Watt dc	■		■			■
Watt ac	■		■			■
Watt ac+dc			■			■
Watt ac+dc (dc blocked)			■			■
Time measurements						
Pulse width	■		■			■
dt	■	■				
1/dt	■	■				
Rise time	■	■				
trig to LEFT		■				
trig to RIGHT		■				
phase		■				
Ampere measurements (with optional current clamps)						
A dc (meter)	■		■			
A ac (meter)	■		■			
A ac+dc (meter)	■		■			
A dc (EXT.mV)	■					■
A ac (EXT.mV)	■					■
A ac+dc (EXT.mV)	■					■
All scope voltage measurements can be read as Amperes						
Temperature measurements (with optional temperature accessories)						
°C	■					■
°F	■					■
Resistance measurements						
Ohm	■			■		
Continuity	■			■		
Diode measurements						
Diode	■				■	

Fluke® windows based software for the ScopeMeter Series IIB

RS stock no. 438-253

FlukeView ScopeMeter software will run on PCs in the Windows environment and can communicate with ScopeMeter via the RS-232 serial interface supplied with the ScopeMeter 105B or as a separate option (RS stock no. 205-738). ScopeMeter 97, the Series IIB ScopeMeter 99B and ScopeMeter 105B, are supported by this powerful software package.

Features of FlukeView

Before the measurement

- Load the ScopeMeter with predefined set-ups from a file, for increased ease of use

During the measurement

- On-line text and graphic display of meter readings for monitoring slow changing signals
- Transfer and store waveforms for later analysis

After the measurement





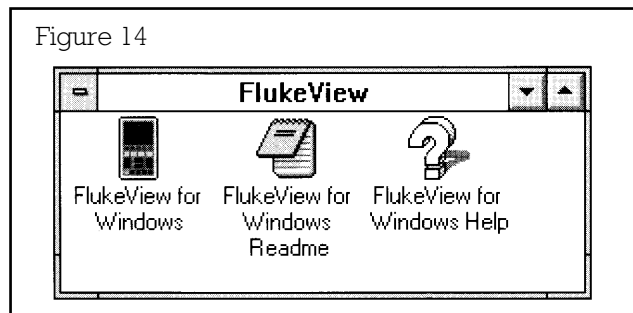





- Transfer and store ScopeMeter screen images for hard copy printing from a PC.
- Store ScopeMeter screen images in popular file formats for documenting measurements in a word processor like Word or WordPerfect.
- Analyse and visually compare waveforms for a closer look at detail.
- Manage the organised storage of waveforms for easy retrieval.
- **Documenting.** Capture waveforms and measurements data from the ScopeMeter screen to the PC. Print out complete screen directly or store graphical data in a popular file format and import into your favourite word processor or spreadsheet.
- **Archiving.** Waveform storage and retrieval with text annotations like measurements conditions and instrument set-ups. Ideal for creating your own library of waveforms for reference and comparison purposes, view your measurements real time on your PC.
- **Analysis.** Get valuable extra measurement data, reveal relationships and conditions that could otherwise remain hidden. You can also log meter readings to monitor and analyse moving signals and related events.
- **On installation.** Once you have installed FlukeView a whole host of facilities become open to you. Under the Windows Program Manager you will find the "FlukeView" files. The icons that appear in the FlukeView file are the major components for your use.

Figure 14



Once you have loaded FlukeView you are presented with the Windows screen, with a tool bar at the top of the screen containing a number of icons. These icons are the most popular facilities that you are likely to use. Beyond this there are the normal pull down menus enabling the user to configure and analyse information at will.

The list below shows some of the tool bar icons and what they do.

Shortcut key	Menu command	Toolbar button
Ctrl + O	File - Open	
Ctrl + S	File - Save As	
Ctrl + P	File - Print	
Ctrl + C	Edit - Copy	
Ctrl + I	Display - Instrument Screen	
Ctrl + W	Display - Waveform	
Ctrl + M	Display - Meter Reading	
Shift + F4	Window - Tile Horizontal	
Shift + F6	Window - Tile Vertical	
Shift + F5	Window - Cascade	
Alt + letter	Selects the menu command with the underlined letter. e.g. Alt+D+O displays the Display - Mode dialog box	
Alt + I + T	Instrument - Setup to file	
Alt + I + F	Instrument - Setup from file	
Alt + F + V	File - Preview	
Esc		

The following waveforms are examples of some of the information/analysis features of the powerful FlukeView software.

Figure 15 Example of a waveform window

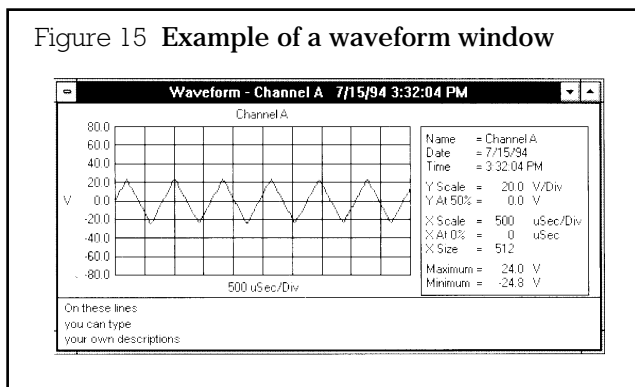

Figure 16 Example of a spectrum window

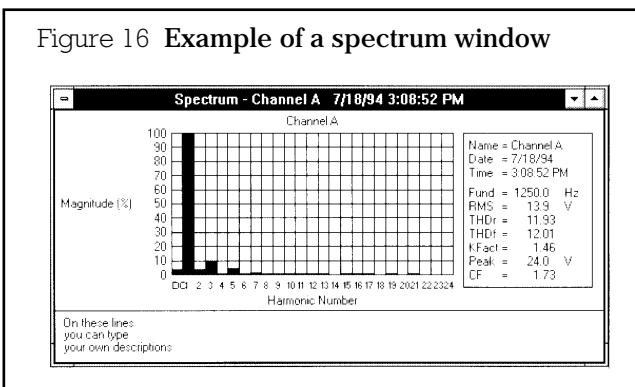

Figure 17 Example of the instrument screen

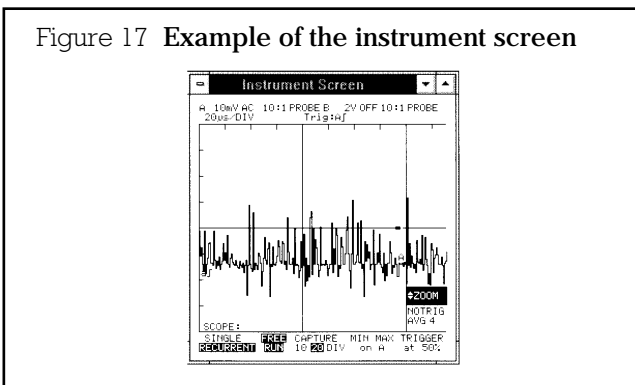

Figure 17 is an example of the instrument screen showing the Fluke ScopeMeter 99B screen with the information directly transferred across.

Specifications and characteristics

Scope mode

Continuous auto set

Hands-free signal probing. Continuously follows input signals from 15Hz to 50MHz and automatically selects the proper time base, input range, and trigger level.

Min max envelope

Records the waveform excursions with a grey-scale envelope on both inputs.

40ns glitch detect

Sweep speeds 1µs per division or slower on INPUT A.

Grey-scale display

Analog-like grey-scale display.

Waveform average

Smoothing up to 256 waveforms. 10 samples in roll mode.

Vertical

Frequency Response, -3 dB _____ DC to > 100MHz
 (Fluke 99B , 105B)
 DC to >60 MHz (Fluke 92B, 96B)
 ac coupled _____ <10 Hz direct, <1 Hz with 10:1 probe
 Coupling _____ AC, DC, Ground
 Rise Time _____ <3,5ns (Fluke 99B, 105B)
 <7ns (Fluke 92B, 96B)
 Sensitivity _____ 1mV to 100V/div
 to 1kV/div with 10:1 probe
 Current probe scaling _____ 1mA/div to 100,000 A/div
 Modes _____ A, -A, B -B, A+B, A-B, A=x B=y
 Input Impedance _____ 1 MΩ//25 pF direct,
 10 MΩ//15 pF with 10:1 probe
 Vertical resolution _____ 8 bit (256 levels)
 Accuracy _____ ±(2% + 1 pixel),
 add 3% for 1 and 2 mV/div

Horizontal

Modes _____ Recurrent, Single Shot, Roll

Ranges

Recurrent _____ 5ns to 1s/div (Fluke 99B, 105B)
 10ns to 1s/div (Fluke 92B, 96B)
 Dual input alternating _____ 5ns (10ns) to 20 µs/div
 Dual input chopped _____ 50µs to 1s/div
 Maximum Sampling rate 5GS/s (Fluke 99B, 105B)
 2.5GS/s (Fluke 92B, 96B)
 Single shot _____ 100ns to 1s/div
 Dual input alternating _____ 100ns to 20µs/div
 Dual input chopped _____ 50µs to 1s/div
 Roll _____ 2s to 60s/div
 Dual input chopped _____ 2s to 60s/div
 Accuracy _____ +(0.1% + pixel)
 Record length _____ 256 or 512 samples
 (10 or 20 division)
 ScopeRecord™ (Fluke 99B, 105B) _____ 30k samples
 from 20ms/div to 60s/div

Trigger (normal mode)

Sources _____ A, B or EXTERNAL
 Sensitivity: A or B _____ <0.8 div to 10MHz
 <1.5div to 60MHz
 <4.0div to 100 MHz
 Sensitivity: EXTERNAL _____ +0.2V or 2.0V
 (TTL level compatible)
 External input impedance _____ 1MΩ/25pF direct,
 10MΩ/15pF with 10:1 probe
 Delay time _____ -20 to +640 div

N-cycle trigger _____ Retrigger after 2 to 255
trigger cycles
Delay by events ____ 1 to 1023 events after EXT trigger

TV Trigger (on INPUT A only)

TV Trigger modes ____ Lines, Frame, Odd/Even fields,
Line Number, 4-Field Sequence
Video Modes _____ Positive and Negative Video
TV Systems _____ NTSC, PAL, PAL-M,
SECAM, Non-Interlaced
Scan Rates _____ 4 to 21kHz, 19 to 33kHz (non-interlaced),
31 to 65kHz (non-interlaced)
TV Trigger Sensitivity _____ 1.5 division (with a minimum of
30 mV) to 21 divisions peak-peak

Cursor Measurements (96B, 99B & 105B)

Up to five displayed simultaneously. All voltage measurements can be ampere measurements with optional Current Probes.

Single cursor measurements:
V1, V2, t1 from TRIG, t2 from TRIG.

Dual cursor measurements:
Hz, Vrms, VDC (mean), Vpeak/peak, V max peak, V min peak, rise time, phase, dV, dt, and 1/dt.

Measurement readout:
absolute, relative (zero), or % change.

Markers selectable on:
Hz, Vpeak/peak, V max peak, V min peak, rise time, and phase.

Waveform mathematics (99B & 105B)

Add, Subtract, Multiply, Invert, Filter, or Integrate input waveforms.

Calculate instantaneous or mean (real) electrical watts with optional Current Probes.

Zoom

Magnifies waveform around the fourth division at the next acquisition (sweep).

Meter Mode

Displays of up to four readings and a full screen scope waveform of INPUT A

dc Voltage

Ranges
direct input _____ 100mV, 300 mV, 1V, 3V, 10V, 30V,
100V, 300V
with 10:1 probe _____ 1V, 3V, 10V, 30V, 100V, 300V,
1kV, 3 kV (limit 600V)

Accuracy _____ $\pm(0.5\% + 5 \text{ counts})$
Full Scale Reading _____ 1000 or 3000 counts
Normal Mode Rejection _____ $>50 \text{ dB}$ at 50 or 60 Hz
Common Mode Rejection _____ $>100 \text{ dB}$ at dc, 50, 60,
or 400Hz

ac or ac+dc True RMS Voltage

Ranges
direct input _____ 100mV, 300mV, 1V, 3V, 10V, 30V,
100V, 250V
with 10:1 probe _____ 1V, 3V, 10V, 30V, 100V, 300V, 1 kV
2.5 kV (limit 600V)

Accuracy(valid from 5% range)
50Hz to 60Hz _____ $\pm(1\% + 10 \text{ counts})$
1Hz [20 Hz] to 20kHz _____ $\pm(2\% + 15 \text{ counts})$
1 Hz [5Hz] to 1MHz _____ $\pm(3\% + 20 \text{ counts})$
1 Hz [5Hz] to 5 MHz _____ $\pm(10\% + 25 \text{ counts})$

Notes:

- [values] for "Vrms ac (no dc)", ac coupled input.
- In "ac+dc", the dc component is included in the measurement result and does not influence the accuracy.

Full Scale Reading _____ 1000 or 3000 counts
Crest Factor ____ Automatic ranging on crest factor overload
Common Mode Rejection Ratio _____ $>60 \text{ dB}$, dc to 60 Hz

Additional Meter Mode Measurements

Frequency _____ 1Hz to 5MHz
Resolution _____ 4 digits
Accuracy _____ $\pm(0.5\% + 2 \text{ counts})$

RPM _____ selectable: 1 pulse/rev. or 1 pulse/2 rev.
Range _____ 60RPM (120 @ 1 pulse/2 rev.) to 99.99kRPM
Resolution _____ 1RPM (10RPM for RPM > 10,000)
Accuracy _____ $\pm(1\% + 10 \text{ counts})$

DUTY CYCLE _____ positive or negative pulse
Range _____ 2.0% to 98.0%
Resolution _____ 0.1%
Accuracy (logic or pulse waveforms) _____ $\pm(0.5\% + 2 \text{ counts})$

PULSE WIDTH _____ positive or negative pulse
Range _____ 250 μ s to 50ms
Resolutions _____ 3 digits
Accuracy _____ $\pm(0.5\% + 2 \text{ counts})$
dBV _____ 1 volt reference
dBm _____ reference @ 50, 60, 75, 93, 110, 125,
135, 150, 250, 300, 500, 600, 800,
900, 1000 or 1200 Ω
dBW or WATTS _____ 1, 2, 4, 8, 16 or 50 Ω reference

ΩMode

(external 4-mm banana jack inputs)

Ranges 30Ω, 300Ω, 3kΩ, 30kΩ, 300kΩ, 3MΩ, 30MΩ
 Accuracy (300Ω to 30MΩ) ±(0.5% +5 counts)
 Accuracy (30Ω) ±(2.5% +25 counts)
 Full Scale Reading 3000 counts
 Measurement Current 500μA, 500μA, 70μA, 7μA, 700nA, 70nA, 70nA
 Open Circuit Voltage <4V
 Full Scale Voltage <250mV to 3MΩ, <2V to 30MΩ
 Community Beeper audible for readings 5% of selected range

Diode Test Mode

(external 4mm banana jack inputs)

Open Circuit Voltage ≤4V
 Full Scale Voltage 2.800V
 Measurement Current 0.5mA
 Continuity Beeper audible for readings <1V

External MV Mode

Displays up to four readings and a full size waveform of the 4mm banana jack input.

dc Voltage

Ranges 300 mV, 3V
 Accuracy ±(0.5% +5 counts)
 Full Scale Reading 3000 counts
 Normal Mode Rejection >50dB at 50 or 60Hz
 Common Mode Rejection 100dB at DC, 50, 60 or 400Hz

ac or ac+dc True RMS Voltage

Ranges 300mV, 3V
 Accuracy DC, 50Hz, and 60Hz. (valid from >5% of range) ±(2% +15 counts)
 OL at >2500 counts in 3V range
 Full Scale Reading 3000 counts
 Crest Factor Automatic ranging on crest factor overload
 Useful Bandwidth 5kHz
 Common Mode Rejection Ratio >60dB, DC to 60Hz

Additional EXTERNAL mV mode measurements

Frequency, RPM, Duty Cycle and Pulse Width measurements and waveforms can also be made with reduced accuracy.

°C/°F TEMPERATURE SCALING for optional temperature probes
 Scaling 1mV/degree

AMPERE SCALING for optional current probes
 Scaling 1mV/A, 10mV/A, 100mV/A, 1V/A (1mV/mA)
 for dc, ac rms, or ac+dc rms

Meter, Ω, Diode, and External mV Mode Functions

Smooth Moving average of readings for about last 8sec.
 Normal <3.5sec. response time for inputs >50Hz
 Fast <1sec. response time for inputs >50Hz
 Change alert™ Audible beep when reading changes
 Touch hold Audible beep and hold of last stable reading
 Relative Zeros present reading as a reference value
 % change % change relative to a reference value
 % scale % of user set 0% and 100% references
 Min Max Simultaneous display of present, maximum, minimum, and average values with time

Min Max trendplot™

Logs minimum, maximum, and average readings to memory at full accuracy and displays all three as graphs. Uses automatic vertical scaling and horizontal time compression for hands-free recording from 120sec. to 40 days full screen.

Minimum, maximum, and average full accuracy (16 bit) waveforms available to PC interface, (99B, 105B).

Memories (save or recall) (96B, 99B and 105B)

Screen all displayed waveforms, readings, and setup, 10 for fluke and 105B, 5 for Fluke 96B
 Waveforms individual waveforms with setting, 20 for fluke 99B and 105B, 10 for Fluke 96B
 Setups complete test tool setting, 40 for Fluke 99B and 105B, 20 for Fluke 96B

Signal generator (99B and 105B)

Sine wave 1V pk-pk at 976Hz
 Source resistance 400Ω
 Square wave 5V pk-pk at 488Hz, 976Hz, or 1.95kHz
 Source resistance 400Ω

Probe calibrator

ac probe adjust at 5pk-pk at 1.95kHz

Component tester (99B and 105B)

Current mode 0 to +3mA in max. 128 steps
 Max. voltage ≤2V
 Voltage mode -2V to +2V in max. 128 steps
 Max. current +or -1mA

General specifications

The accuracy of all measurements is within +(% of reading + number of counts) from 18°C to 28°C. Add 0.1 x (specific accuracy) for each °C <18°C or >28°C.

Display

Foil compensated super twisted liquid crystal
 Size 84 x 84mm (4.7" diagonal)
 Resolution 240 x 240 pixels, 25 pixels/div. in SCOPE mode

Contrast _____ user adjustable
 Backlight _____ Cold cathode fluorescent (CCFL) tube
 High brightness _____ 50cd/m²

Power

Internal battery pack _____ NiCd 4.8V nominal

Operating time _____ Typical 4 hours

Power adaptor/battery charger

Charging time _____ Typical 21 hours

Alternate battery _____ 4 alkaline C cells
 (non-recchargeable)

External supply _____ 8 to 20Vdc, 5W typical via 5mm jack

WARNING: The minus voltage is connected to common. When using a power supply that is not double insulated, connect common to protective grounding.

Memory back-up battery (96B, 99B and 105B) CR2032 save screens, waveforms and setups for up to three years after main batteries removed.

Mechanical

Size excluding holster _____ 60 x 130 x 260mm
 (2.4 x 5.1 x 10.2inches)

Size including holster _____ 65 x 140 x 275mm
 (2.5 x 5.5 x 10.8inches)

Weight excluding holster _____ 1.5kg (3.3lbs)

Weight including holster _____ 1.8kg (4.0lbs)

Environmental

Temperature

Operating _____ 0°C to 50°C

Storage _____ -20°C to 70°C

Humidity

Operating _____ 20°C to 30°C, 90% RH non-condensing
 30°C to 50°C, 70% RH non-condensing

Storage _____ 95%RH

Altitude

Operating _____ 3km (10,000ft)

Storage _____ 12km (40,000ft)

Shock and Vibration _____ per MIL-T-28800 for Class 3

Electromagnetic interference _____ per MIL STD 461

Ordering information

Description	RS stock no.
Fluke ScopeMeter 92B	214-5098
+ NAMAS CAL	214-5313
+ Spoint CAL	214-5329
Fluke ScopeMeter 96B	214-5105
+ NAMAS CAL	214-5335
+ Spoint CAL	214-5341
Fluke ScopeMeter 99B	214-5111
+ NAMAS CAL	214-5357
+ Spoint CAL	214-5363
Fluke ScopeMeter 105B	214-5127
+ NAMAS CAL	214-5379
+ Spoint CAL	214-5385

Accessories for the Fluke ScopeMeter Series IIB

Description	RS stock no.
FlukeView software	438-253
RS-232 serial interface link	205-738
Soft carrying case	205-744
Hard carrying case	205-750
Oscilloscope probe set	205-766

®All trademarks acknowledged

Glossary of terms

ac

See "Alternating Current".

ac coupling

A mode of signal transmission that passes the dynamic ac signal component to the instrument input but blocks the dc component. This is useful to observe an ac signal that is riding on a dc level.

Alternating current

An electric signal in which current and voltage vary in a repeating pattern over time.

Adjustable speed motor drive (ASD)

An electronic apparatus for speed control of ac motors. An ASD controls the motor speed by converting the frequency and voltage of the main power supply from fixed to variable values.

The main advantages are energy savings; process improvement by allowing more control of material rates in production lines, and reduction of wear on machinery by reducing the stops and start required by fixed speed motors.

Amp, Ampere (A)

The unit of electric current in the mks system of units.

Average responding meter

A meter that assumes that the ac waveform being measured is a sinewave, senses the average value of the rectified sinewave and then displays the equivalent rms value of the sinewave. This technique can give incorrect readings if the current waveform is not a sinewave (e.g. it is a sinewave distorted due to harmonics).

Ballast (lighting)

A circuit element that provides a starting voltage for certain types of lamps, such as fluorescent lamps. Also used to describe circuit elements that limit an electric current.

Continuous autose

A feature in ScopeMeter Series II which continuously adjusts the Scope timebase, amplitude and trigger to track input signal changes. Similar to Auto Ranging but more.

Current probe (or current clamp)

An instrument or instrument accessory that is used to measure the magnitude of electric current. A current probe allows current measurement to be made without breaking the electrical circuit on which the measurement is taken.

Current waveform

A pictorial representation of current amplitude-obtained by plotting the amplitude of the current as a function of time.

dc

Direct current. Electric current that flows in one direction only, as opposed to alternating current. Although dc literally applies to current, it is also used when referring to voltage as in "dc Volts".

Derating (Transformer)

The reduction of the rating of a transformer to improve reliability or to permit safe operation in the presence of current harmonics, inadequate ventilation or high ambient temperature.

DMM

Digital multimeter, capable of measuring several electrical parameters such as voltage, current, frequency, resistance etc.

Double insulation

Insulation that is usually constructed in two parts. Having the basic insulation required to isolate live parts, providing protection against electric shock and fire. It also has independent insulation, providing protection in the event of failure of the basic insulation. This is indicated on the instrument by the double insulation symbol, which is a "square surrounded by a square".

Double insulation is also applied to a single layer of insulation that has been tested to withstand a high voltage (reinforced insulation).

Effective current

The value of an ac current that will give the same heating effect as the corresponding value of dc current. Also known as the rms current.

Float voltage

The difference in potential between the measurement common conductor of an instrument or accessory and earth potential.

Frequency

The number of cycles completed by a periodic quantity in a unit of time. The measurement unit for frequency is the Hertz (Hz). For example, current in a power distribution system completes 60 cycles in a second (60 Hertz).

Fundamental frequency

The lowest frequency of voltage or current in the power system (usually 50Hz or 60Hz depending on locale).

Glitch detect

The ability of a test instrument to capture fast transients of volt transitions. ScopeMeter test tools can capture glitches as fast as 40ns.

Harmonic

A whole number multiple of the fundamental frequency. Harmonics are named by harmonic number, ie. fundamental = 60Hz, 2nd harmonic = 120Hz, 3rd harmonic = 180Hz, etc.

Harmonic distortion

Distortion in which undesired harmonics of the 50 or 60Hz powerline fundamental are present because of nonlinear loads.

Insertion impedance

The increase in impedance that occurs when a current clamp is clamped around a conductor. Even though a current clamp does not physically break the circuit being measured, it does in fact affect the current slightly. This is expressed as an impedance in the circuit, called the insertion impedance.

Load

A device that consumes electric power, or the amount of electric power that is drawn from a power line, generator or other power source.

Load imbalance

In a multi-phase power distribution system, the condition in which the sum of the phase currents do not add up to zero.

Neutral conductor

The grounded conductor in a power system. The neutral carries imbalance and/or 'triplen' harmonic currents.

Non-linear load

A load that does not draw a sinewave current from a sinewave voltage. These loads typically contain arcing devices or semiconductors that switch the current off and on abruptly. These abrupt changes result in harmonics in the current carrying conductors.

Peak (half cycle)

The maximum value of a repetitive waveform on each half cycle. This is typically greater than the rms value of the waveform. This assumes that high frequency noise is filtered out of the waveform being measured.

Peak (instantaneous)

The maximum value of a waveform (determined within the bandwidth limitation of the measurement system). This type of peak is measured using an instrument that responds to high frequency inputs and the measured value will be greater than or equal to the value obtained for the half cycle peak. Compare with Peak (half cycle).

Peak (motor starting)

The rms value of the current drawn by a motor at start-up. The current at start-up is initially high to overcome the inertia of a motor that is not turning.

Phase shift

The displacement in time of one periodic waveform relative to another waveform. In a measurement system, it is the displacement (measured in degrees) between the input (e.g. current being measured) and the output, (e.g. waveform display on an oscilloscope).

Rated voltage

The maximum circuit voltage that an instrument is designed to be used on. Use of an instrument in circuits where higher voltage is present is considered misuse.

Reinforced insulation

A single insulation system applied to live parts that gives the equivalent protection of double insulation. This protection may be due to increased thickness of a single layer of insulation or may include several layers.

Rise (or fall) time

If a steady-state increment (of current) is applied to the input (of a current probe), the time it takes for the output of a device to change from 10% to 90% of its steady-state increment.

RMS current (Root-Mean-Square current)

The value of an ac current that will give the same heating effect (in a resistive load) as the corresponding value of dc current. Also known as the effective current.

Temperature coefficient

The rate of change of some parameter (such as the current probe accuracy) with respect to temperature. Also called the 'influence of temperature'.

Transformer

An electrical component consisting of two (or more) coils of wire placed in close proximity to cause the magnetic field of one to link the other. Used in power distribution systems to step down (or step up) the voltage from one section of the system to another. Also, the jaws and output of a current clamp are a kind of transformer in which one 'coil' is the conductor whose current is being measured and the other coil is wound in the jaws of the clamp.

TrendPlot

A unique ScopeMeter function allowing a low speed signal to be plotted, like a chart recorder, for up to 40 days. All the data is kept on the display and can be time correlated.

Trigger

An input level (on an oscilloscope) that is used to initiate the display or capture of a waveform.

Trigger, free run

An automatic trigger function in oscilloscopes which causes a trace to appear on the screen even without an input signal.

Trigger, single

An oscilloscope trigger setting which causes the signal to start the scope trace and then freezes the trace on screen. Commonly referred to as single shot.

Triplens

A family of harmonics that includes the 3rd and odd multiples of the 3rd (9th, 15th, 21st, etc). The triplens are "zero sequence" which means that they add in the neutral of a 3-phase, 4-wire system causing neutrals and transformers to overheat.

Uninterruptible power supply (UPS)

A power supply which supplies power regardless of the state of the power mains. Used to ensure that critical equipment operates during power outages or brownouts.

Usable frequency range

Used here as the range of frequencies in which the output varies no more than 3dB (approximately 30%) from the input. It is used to characterise the frequency response of an instrument.

®Fluke ScopeMeter and FlukeView are registered Trade Names of Fluke Corporation USA.

The information provided in **RS** technical literature is believed to be accurate and reliable; however, RS Components assumes no responsibility for inaccuracies or omissions, or for the use of this information, and all use of such information shall be entirely at the user's own risk.
No responsibility is assumed by RS Components for any infringements of patents or other rights of third parties which may result from its use.
Specifications shown in RS Components technical literature are subject to change without notice.
