



DSP-4000 Series

CableAnalyzer™

Getting Started Guide

July 2001, Rev. 1, 5/03

© 2001-2003 Fluke Corporation. All rights reserved. Printed in USA.

All product names are trademarks of their respective companies.

Accessing the Users Manual

The DSP-4000 Series Users Manual is available on the DSP-4000 Series Manual CD included with your test tool.

Contacting Fluke Networks

Visit the Fluke Networks web site at www.flukenetworks.com. Send email to support@flukenetworks.com.

To order accessories or get the location of the nearest Fluke Networks distributor or service center, call:

- USA: 1-888-99-FLUKE (1-888-993-5853)
- Canada: 1-800-363-5853
- Europe: +44 1923 281 300
- Beijing: 010-65123435
- Japan: +81-3-3434-0181
- Singapore: +65-6738-5655
- Anywhere in the world: +1-425-446-4519

For operating assistance in the USA, call 1-800-283-5853.

Table of Contents

Title	Page
Introduction	1
Registration.....	1
Standard Accessories	2
Safety and Operational Information	3
Main Unit Features	6
Remote Features	9
Permanent Link Interface Adapters (DSP-4000PL/4300)	12
Setting Up the Test Tool	13
Powering the Test Tool	13
Turning On the Test Tool	14
Selecting a Language	14
Quick Configuration	14
Using the Link Interface Adapters	16
Checking the Memory	17
Formatting the Memory Card (DSP-4100/4300)	17

Setting Up Cable IDs	17
Auto Increment	17
Auto Sequence	17
Selecting a List of Downloaded IDs (DSP-4300)	18
Testing Cabling	18
Diagnosing Cabling Problems	18
Saving Autotest Results	19
DSP-4000	19
DSP-4100/4300	19
Calibrating the Test Tool	19
Getting Software Upgrades	19

DSP-4000 Series CableAnalyzers™

Introduction

The Fluke Networks DSP-4000 Series CableAnalyzers™ (hereafter referred to as “the test tool”) are hand-held instruments used to certify, test, and troubleshoot coaxial and twisted pair cabling in local area network (LAN) installations. The test tool combines test pulses with digital signal processing to provide fast, accurate results and advanced testing capabilities up to 350 MHz.

Registration

Registering your product with Fluke Networks gives you access to valuable information on product updates, troubleshooting tips, and other support services. To register, fill out and return the postage-paid card provided, or fill out the online registration form on the Fluke Networks website.

Standard Accessories

A DSP-4000 Series test tool comes with the following accessories. If the test tool is damaged or something is missing, contact the place of purchase immediately.

- 1 DSP-4000SR, DSP-4100SR, or DSP-4300SR remote unit
- The following link interface adapters:
 - ◇ With the DSP-4000 and DSP-4100: 2 DSP-LIA011 Basic Link Adapters for Cat 5E and 2 DSP-LIA012 Channel Adapters for Cat 6
 - ◇ With the DSP-4000PL: 2 DSP-LIA101 Permanent Link Adapters for Cat 6 and 2 DSP-LIA012 Channel Adapters for Cat 6
 - ◇ With the DSP-4300: 2 DSP-LIA101 Permanent Link Adapters for Cat 6, 1 DSP-LIA012 Channel Adapter for Cat 6, and 1 DSP-LIA013 Channel/Traffic Adapter for Cat 6
- 2 AC adapter/chargers 120 V (US only) or universal adapter/chargers and line cords (outside North America)
- 1 Memory card reader (DSP-4100, DSP-4300)
- 1 16 MB memory card (DSP-4100, DSP-4300)
- 1 Memory card carrying case (DSP-4100, DSP-4300)





- 2 NiMH battery packs (installed)
- 2 Headsets
- 1 DSP-4000 Calibration Module
- 1 RJ45 to BNC adapter
- 1 PC serial interface (EIA-232C) cable
- 2 Carrying straps
- 1 LinkWare™ software CD
- 1 DSP-4000 Series Manual CD (includes complete users manual)
- 1 DSP-4000 Series Getting Started Guide
- 1 Warranty registration card
- 1 Soft carrying case

If you purchased optional Fiber Test Adapters, refer to the Fiber Test Adapter users manual for a list of fiber accessories.

Safety and Operational Information

The international electrical symbols used on the instrument or in this manual are described in Table 1.

Table 1. International Electrical Symbols

	Warning: Risk of electric shock.
	Warning or Caution: Risk of damage or destruction to equipment or software. See explanations in the manual.
	Equipment is protected by double insulation or reinforced insulation to protect the user against electric shock.
	Do not connect this terminal to public communications networks, such as telephone systems.

Warning

To avoid possible fire, electric shock, personal injury, or damage to the test tool

- If this product is used in a manner not specified by the manufacturer, the protection provided by the product may be impaired.
- Use only the ac adapter/charger provided with the test tool (PN 106200 or 944223) to charge the battery or power the test tool.
- Never connect the test tool to any telephony inputs, systems, or equipment, including ISDN. Doing so is a misapplication of this product, which can result in damage to the test tool and create a potential shock hazard to the user.

- **Never connect the CABLE TEST input to any LAN inputs, systems, or equipment. Doing so is a misapplication of this product, which can result in damage to the test tool and create a potential shock hazard to the user.**
- **Always turn on the test tool before connecting it to a cable. Turning the test tool on activates the tool's input protection circuitry.**
- **When servicing the test tool, use only specified replacement parts.**
- **Do not use the test tool if it operates abnormally. Protection may be impaired.**
- **Do not use the test tool if it is damaged. Inspect the test tool before use.**

Caution

To avoid disrupting network operation and to ensure maximum accuracy of test results

- **Except when monitoring network activity, never connect the test tool to an active network. Doing so may disrupt network operation.**
- **Never attempt to insert any connector other than an RJ45 connector into the RJ45 jack. Inserting other connectors, such as RJ11 (telephone) connectors, can permanently damage the jack.**
- **Never attempt to send data from a PC to the test tool while running a cable test. Doing so might cause erroneous test results.**

- **Never operate portable transmitting devices during a cable test. Doing so might cause erroneous test results.**
- **When using the channel/traffic link interface adapter (DSP-LIA013), never run tests with cables connected to both the cable jack and the monitor jack. Doing so might cause erroneous test results.**
- **To ensure maximum accuracy of test results, perform the self-calibration procedure as described in “Calibrating the Test Tool” in Chapter 6 of the Users Manual every 30 days.**
- **To avoid false test results, recharge the battery as soon as the low battery message appears.**
- **If your test tool includes the DSP-LIA101 Permanent Link Adapters, see “Permanent Link Interface Adapters” for important handling information.**

Main Unit Features

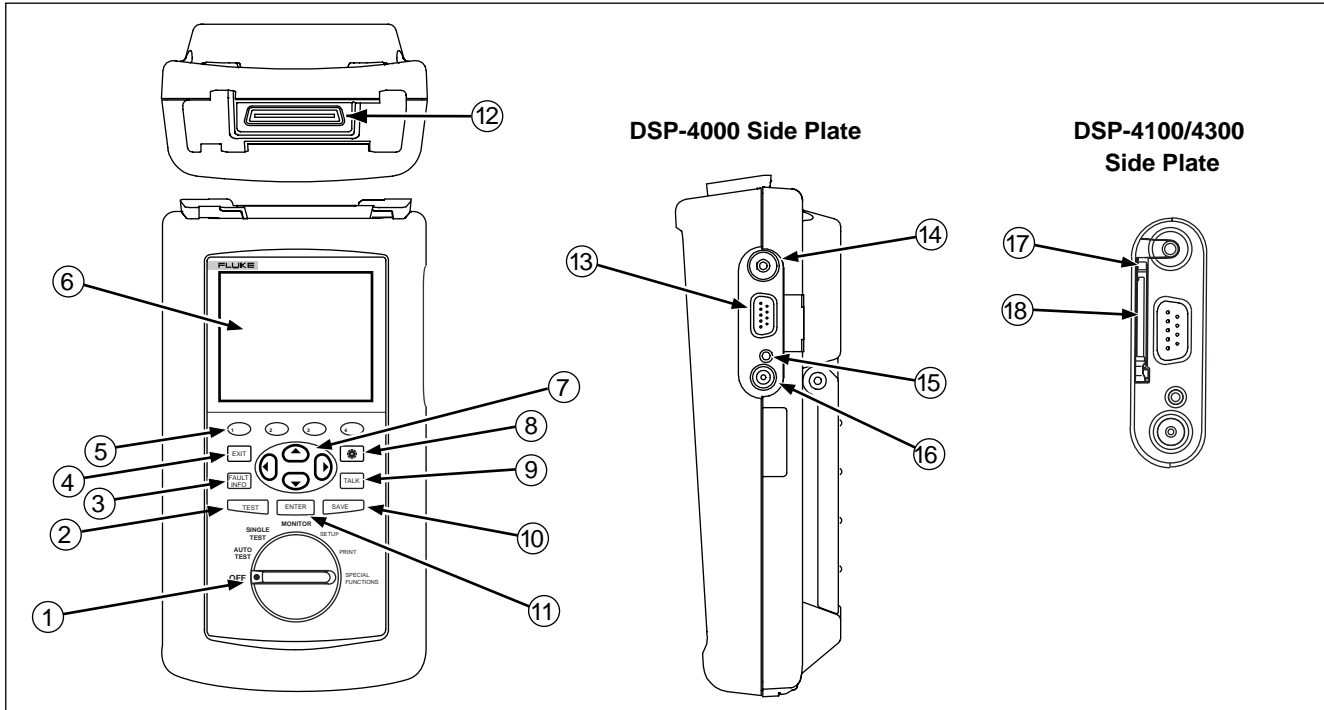

Figure 1. Main Unit Features

ank05f.eps

Table 2. Main Unit Features









Item	Feature	Description
①	Rotary Switch	Selects the test tool's modes.
②		Starts the highlighted test or restarts the test last run.
③		Automatically provides more specific information on the cause of an Autotest failure.
④		Exits the current screen without saving any changes you made.
⑤		Provide functions related to the concurrent display. Softkey functions are shown in the display area above the keys.
⑥	Display	A LCD display with backlight and adjustable contrast.
⑦		Allow left, right, up, and down movement on the display. Increase or decrease the numerical values of user-definable parameters.
⑧		Controls the display backlight. Pressing for 1 second allows adjustment of the display contrast. Reactivates the test tool when the tool is in power down mode.
⑨		Lets you use the headset for two-way voice communication over twisted pair or fiber cable.
⑩		Saves Autotest results and parameter changes in memory.
⑪		Selects the highlighted item from a menu.
⑫	LIA connector and latch	Connector and latch for the link interface adapters (LIAs).
⑬	RS-232C serial port	A 9-pin connector for interfacing with a printer or host computer via a standard IBM-AT EIA RS-232C serial cable.
⑭	2.5 mm phone jack	Connection for the headset supplied with the test tool.

Table 2. Main Unit Features (cont.)

Item	Feature	Description	
⑮	AC power indicator	LED off, unit turned off	Battery is not charging. The charger is not plugged in.
		LED off, unit turned on	Battery is not charging. The charger is not plugged in or the test tool is running a test. When the test is finished, charging resumes unless the battery is already charged (>80%).
		LED flashing red	Fast charge pending. Charging is beginning. This state may last for several minutes until fast charging begins.
		LED steady red	Fast charge. The unit stays in fast charge mode for up to 4 hours, or until either the battery is fully charged or a test is initiated.
		LED steady green	Charge complete. Fast charge is complete. The unit enters trickle charge mode.
⑯	AC adapter/ charger jack	Connection for the ac adapter/charger supplied with the test tool.	
⑰	Eject button (DSP-4100/4300)	Button for ejecting the memory card.	
⑱	Memory card slot (DSP-4100/4300)	Slot for the memory card used for saving Autotest results on a DSP-4100 or DSP-4300 test tool.	

Remote Features

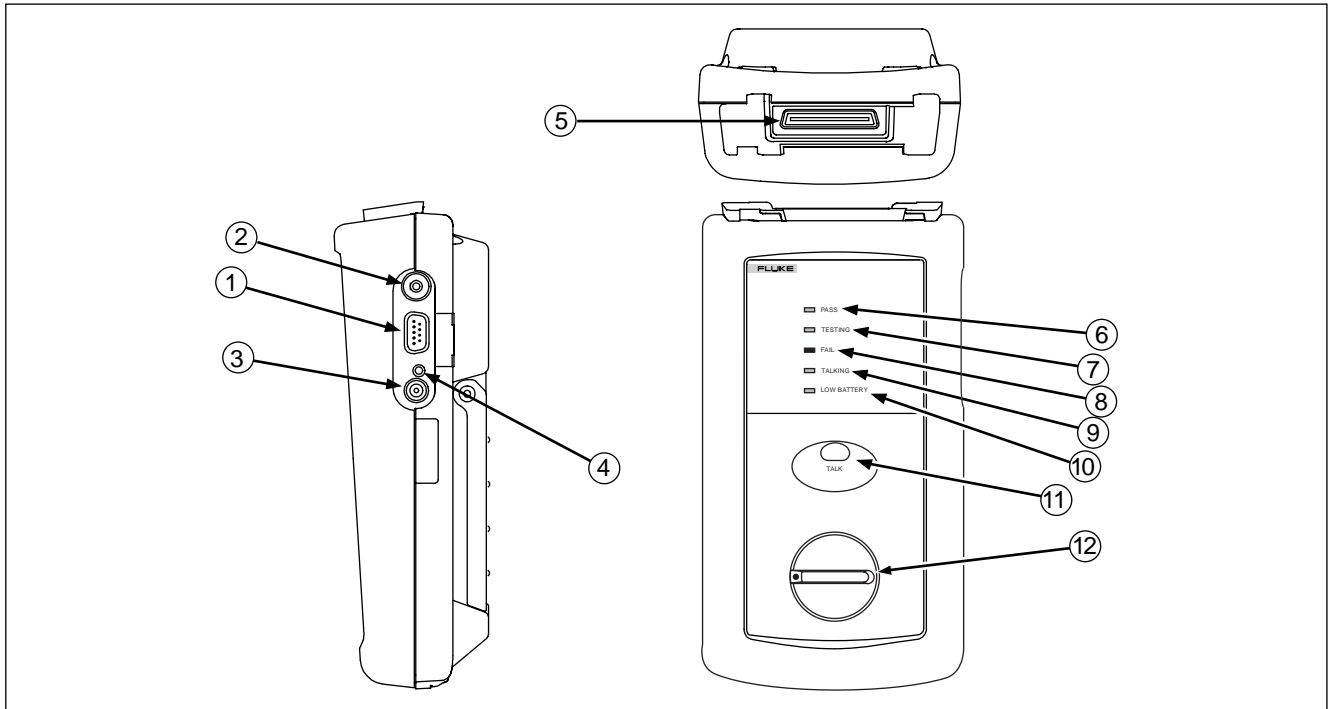

ank06f.eps

Figure 2. Remote Features

Table 3. Remote Connectors and Features

Item	Feature	Description	
①	RS-232C serial port	A DB9P connector for loading software updates.	
②	2.5 mm phone jack	Connection for the headset supplied with the test tool.	
③	AC adapter/ charger jack	Connection for the ac adapter/charger supplied with the test tool.	
④	AC power indicator	LED off, unit turned off	Battery is not charging. The charger is not plugged in.
		LED off, unit turned on	Battery is not charging. The charger is not plugged in or the test tool is running a test. When the test is finished, charging resumes unless the battery is already charged (>80%).
		LED flashing red	Fast charge pending. Charging is beginning. This state may last for several minutes until fast charging begins.
		LED steady red	Fast charge. The unit stays in fast charge mode for up to 4 hours, or until either the battery is fully charged or a test is initiated.
		LED steady green	Charge complete. Fast charge is complete. The unit enters trickle charge mode.

Table 3. Remote Connectors and Features (cont.)

Item	Feature	Description
⑤	LIA connector and latch	Connector and latch for attaching link interface adapters.
⑥	Pass LED	A green LED that turns on at the end of a test if no faults were detected.
⑦	Test LED	A yellow LED that turns on when a test is in progress.
⑧	Fail LED	A red LED that turns on at the end of a test if one or more faults were detected.
⑨	Talking LED	A LED that turns on when the Talk mode is active.
⑩	Low-battery LED	A LED that turns on when the remote battery voltage is low.
⑪		Lets you use the headset for two-way voice communication over twisted pair or fiber cable. When the Talk mode is active, this button controls the headset volume.
⑫	Rotary switch	On/off switch for remote.

Permanent Link Interface Adapters (DSP-4000PL/4300)

Caution

To avoid damaging the adapter and to ensure maximum accuracy of test results, never pinch, kink, or crush the adapter's cable. Never use the cable as a handle to pick up the DSP test tool. Follow the handling guidelines given in Figures 3 and 4.

For the best accuracy, keep the adapter's cable as straight as possible during testing.

To avoid latent or immediate damage due to electrostatic discharge:

- Before handling a module or an adapter with no module attached, ground yourself when possible by touching a grounded, conductive surface.
- Always remove the adapter from the DSP test tool before changing the personality module.
- Always keep a personality module attached to the adapter cable.

- Tighten the screw snugly with your fingers only. Do not overtighten. Doing so can damage the module or the end of the cable.
- Always store the personality module in its original, static protection bag when not in use.

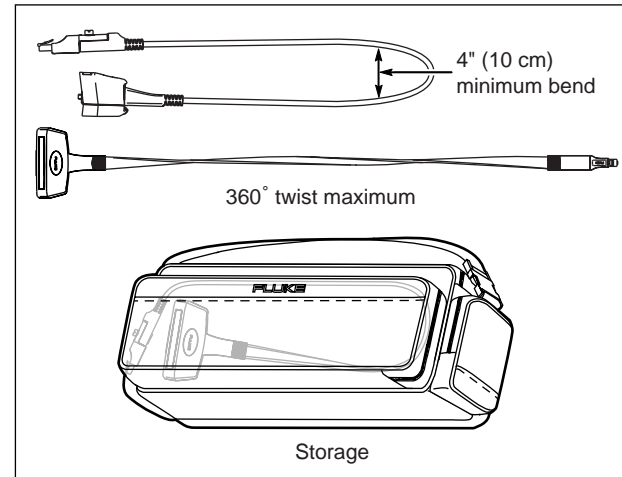

Figure 3. Permanent Link Adapter Handling Guidelines

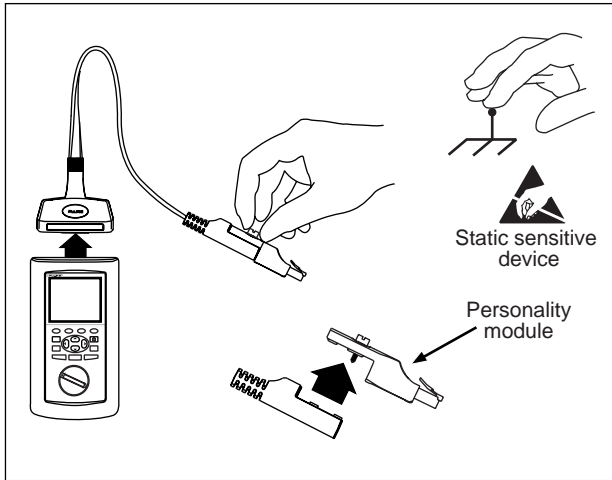

Figure 4. Changing the Personality Module

Setting Up the Test Tool

Powering the Test Tool

Before powering the test tool or remote with the NiMH battery pack, charge the battery for about 3 hours. To charge the battery, connect the ac adapter/charger to the test tool or remote and to ac line power. You can operate the unit on ac power while the battery charges. A fully-charged battery typically lasts at least 8 hours.

To check the battery status, turn the rotary switch to SPECIAL FUNCTIONS; then select **Battery Status**.

Note



The ac adapter/charger will not power the test tool when the battery pack is removed.

Turning On the Test Tool

To turn on the test tool, turn the rotary switch from OFF to any one of the available modes. The power-up screen, which appears for about 3 seconds, shows the software, hardware, and test standards versions for the main and remote units. (The remote information is shown only if the remote is on and connected to the main unit.)

During the power up cycle the test tool performs a self test. If an error message appears, refer to “If the Test Tool Fails” in Chapter 8 of the users manual on the DSP-4000 Series Manual CD.

Selecting a Language

The test tool displays a language selection screen if a language has not been selected since the tool left the factory. Use   to select a language; then press . You can change the selected language at any time in SETUP mode.

Quick Configuration

Table 4 describes the settings you will most likely need to change to configure the test tool for your needs.





To access the settings, turn the rotary switch to SETUP. Use  **Page Down** and   to locate and highlight a setting; then press  to see the available choices.

Table 4. Quick Configuration Settings

SETUP Setting	Description
Test Standard and Cable Type	Select the test standard and cable type you are using. Fiber optic cable testing requires a Fluke Networks DSP-FTA Fiber Test Adapter or a Fluke Networks DSP-FOM (Fiber Optic Meter; comes with the DSP-FTK).
Report Identification	Enter your company's name, operators' names, and site names. These names appear in the Autotest reports you save.
Auto Increment (cable ID setup)	Enabling this setting causes the last character of the cable ID to increment each time you save an Autotest. The Sequence selection lets you define a range of cable IDs by entering a start and end ID. On a DSP-4300, the Cable ID List selection lets you select a list of IDs that was created and saved on a memory card with LinkWare software.
Store Plot Data (DSP-4100/4300)	Enable this setting to store plot data (from tests such as attenuation, return loss, and NEXT) with Autotest results saved on a DSP-4100 or DSP-4300 test tool.
Date and Time	Set the date and time and select a format for each.
Length Units	Select meters or feet as the unit for length measurements.
Numeric Format	Select a format (0.00 or 0,00) for display of decimal fractions.
Language	Select a language for the display.
Power Line Noise Filter Frequency	Select the frequency of the ac power in your area. The test tool filters out 50 Hz or 60 Hz noise from measurements.

Using the Link Interface Adapters

The link interface adapters provide the correct connectors and interface circuitry for testing different types of LAN cabling. The adapters also allow for upgrades when new types of cable are developed.

If your test tool includes the DSP-LIA101 Permanent Link Adapters, see “Permanent Link Interface Adapters” on page 12 for important handling information.

Optional link interface adapters that provide additional functions are available from your Fluke Networks dealer. Visit the Fluke Networks website at **www.flukenetworks.com** for the most recent information on optional adapters.

Figure 5 shows how to attach a link interface adapter. Refer to Appendix A in the Users Manual for a list of tests supported by the standard link interface adapters.

Note

The test tool displays a message if you try to run a test not supported by the attached link interface adapter.

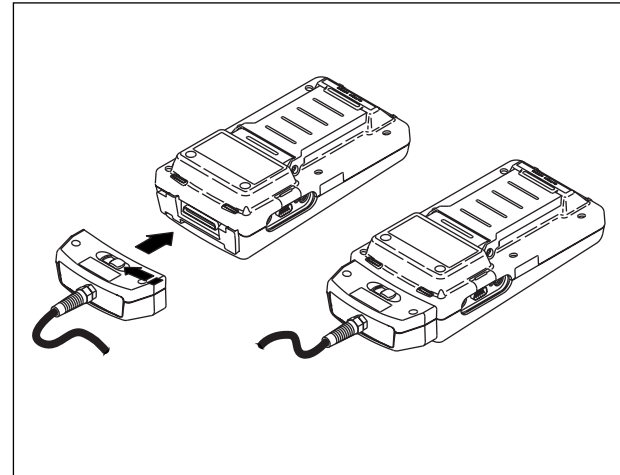

ank72f.eps

Figure 5. Attaching a Link Interface Adapter

Checking the Memory

To check the available memory space, turn the rotary switch to AUTOTEST; then press **4** **Memory**.

Formatting the Memory Card (DSP-4100/4300)

Autotest results you save on a DSP-4100 or DSP-4300 test tool are stored on a removable memory card. To format a memory card, insert the card into the test tool, select **Memory Card Configuration** from the SPECIAL FUNCTIONS menu; then press **4** **Format**.

Setting Up Cable IDs

The cable identification (cable ID) is the name you assign to the Autotest results saved for a cable. You can create a cable ID each time you save an Autotest, or you can use IDs generated as follows:

Auto Increment

The auto increment function generates IDs by incrementing the last alphanumeric character in the cable ID. To enable this function, select **Enable** under **AUTO INCREMENT** in SETUP.

The last character of the cable ID you enter when you save the next Autotest will be incremented when you save subsequent Autotests.

Auto Sequence

The auto sequence function increments letters and numbers starting with the farthest right character, then moving left. Special characters (such as -, #, and spaces) and matching characters are not incremented.

To enable this function, select **Sequence** under **AUTO INCREMENT** in SETUP. Press **4** **Edit ID Seq.** to enter a start and end ID for the sequence. When you save an Autotest, the test tool displays the ID list. Used IDs are preceded by a "\$".

Selecting a List of Downloaded IDs (DSP-4300)

On a DSP-4300 test tool you can select cable IDs from lists created with LinkWare software and saved on a memory card. See "Getting Started" under Help on the LinkWare toolbar for details on creating ID lists.

To enable this function, select **Cable ID List** under **AUTO INCREMENT** in **SETUP**. Press  **Select ID List** to choose a list on the memory card. When you save an Autotest, the test tool displays the ID list. Used IDs are preceded by a "\$".

Testing Cabling

1. Attach the appropriate link interface adapters to the main and remote units. Turn on the remote unit.
2. Turn the rotary switch on the main unit to **AUTOTEST**.
3. Verify that the test standard and cable type are correct. You can change these settings in the **SETUP** mode.
4. Connect the main and remote units to the near and far ends of the link.
5. Press  to start the Autotest.

Diagnosing Cabling Problems

If an Autotest fails, you can press  to see more specific information on the cause of the failure. For most types of failures, the test tool shows the distance to the fault and suggests what to check in the link.

The **SINGLE TEST** mode on the rotary switch allows individual execution of many of the tests available in the Autotest mode. Single tests help you isolate cabling failures and quickly determine if repairs are good. Some Single Tests include a "Scanning" mode that runs the test continuously to help you identify intermittent problems.

Note

To extend battery life, connect the ac adapter/charger when using the scanning function for more than 1 minute.

Saving Autotest Results

To save the Autotest results, press **SAVE**. Depending on which cable ID function is enabled in SETUP, you can either create a cable ID or select an ID from a pre-configured list. Press **SAVE** again after creating or selecting an ID.

DSP-4000

A DSP-4000 test tool can store the results of 500 or more Autotests, depending on the test standard used. Results are stored in text-based format.

DSP-4100/4300

A DSP-4100 or DSP-4300 test tool with STORE PLOT DATA enabled can store at least 250 Autotests in graphical format on a 16 MB memory card, depending on the standard used.

If no memory card is present in a DSP-4300 test tool, test results are saved to internal memory. Later, when you insert a memory card, the test tool lets you choose whether or not to copy the saved results from internal memory to the memory card.

Note for Model DSP-4300

To avoid confusion regarding the contents of the internal memory, save test results on a removable memory card whenever possible.

Calibrating the Test Tool

To ensure maximum accuracy of test results, perform the self-calibration every 30 days. Select **Self Calibration** from the SPECIAL FUNCTIONS menu. See Chapter 6 of the Users Manual for details.

Fluke Networks recommends factory calibration once a year to ensure that the test tool meets or exceeds the published accuracy specifications. To return a unit to Fluke Networks for calibration, call an authorized Fluke Networks Service Center for return instructions.

Getting Software Upgrades

Keeping your test tool's software current gives you access to new features and the latest test standards. Software upgrades are available for free on the Fluke Networks website. See the online documentation in LinkWare for information on installing upgrades.

LIMITED WARRANTY & LIMITATION OF LIABILITY

Each Fluke Networks product is warranted to be free from defects in material and workmanship under normal use and service. The warranty period is one year and begins on the date of purchase. Parts, accessories, product repairs and services are warranted for 90 days. This warranty extends only to the original buyer or end-user customer of a Fluke Networks authorized reseller, and does not apply to disposable batteries, cable connector tabs, cable insulation-displacement connectors, or to any product which, in Fluke Networks' opinion, has been misused, altered, neglected, contaminated, or damaged by accident or abnormal conditions of operation or handling. Fluke Networks warrants that software will operate substantially in accordance with its functional specifications for 90 days and that it has been properly recorded on non-defective media. Fluke Networks does not warrant that software will be error free or operate without interruption.

Fluke Networks authorized resellers shall extend this warranty on new and unused products to end-user customers only but have no authority to extend a greater or different warranty on behalf of Fluke Networks. Warranty support is available only if product is purchased through a Fluke Networks authorized sales outlet or Buyer has paid the applicable international price. Fluke Networks reserves the right to invoice Buyer for importation costs of repair/replacement parts when product purchased in one country is submitted for repair in another country.

Fluke Networks' warranty obligation is limited, at Fluke Networks' option, to refund of the purchase price, free of charge repair, or replacement of a defective product which is returned to a Fluke Networks authorized service center within the warranty period.

To obtain warranty service, contact your nearest Fluke Networks authorized service center to obtain return authorization information, then send the product to that service center, with a description of the difficulty, postage and insurance prepaid (FOB Destination). Fluke Networks assumes no risk for damage in transit. Following warranty repair, the product will be returned to Buyer, transportation prepaid (FOB Destination). If Fluke Networks determines that failure was caused by neglect, misuse, contamination, alteration, accident or abnormal condition of operation or handling, or normal wear and tear of mechanical components, Fluke Networks will provide an estimate of repair costs and obtain authorization before commencing the work. Following repair, the product will be returned to the Buyer transportation prepaid and the Buyer will be billed for the repair and return transportation charges (FOB Shipping Point).

THIS WARRANTY IS BUYER'S SOLE AND EXCLUSIVE REMEDY AND IS IN LIEU OF ALL OTHER WARRANTIES, EXPRESS OR IMPLIED, INCLUDING BUT NOT LIMITED TO ANY IMPLIED WARRANTY OF MERCHANTABILITY OR FITNESS FOR A PARTICULAR PURPOSE. FLUKE NETWORKS SHALL NOT BE LIABLE FOR ANY SPECIAL, INDIRECT, INCIDENTAL OR CONSEQUENTIAL DAMAGES OR LOSSES, INCLUDING LOSS OF DATA, ARISING FROM ANY CAUSE OR THEORY.

Since some countries or states do not allow limitation of the term of an implied warranty, or exclusion or limitation of incidental or consequential damages, the limitations and exclusions of this warranty may not apply to every buyer. If any provision of this Warranty is held invalid or unenforceable by a court or other decision-maker of competent jurisdiction, such holding will not affect the validity or enforceability of any other provision.

Fluke Networks
PO Box 777
Everett, WA 98206-0777
USA