

VIavi



**Digital  
Services  
Activation  
Meter (DSAM)**

## DSAM — An All-in-One Tester Designed for Your Business

Simply being able to test complete digital and internet protocol (IP) services is not enough in today's market. You need test equipment that empowers your field workforce, improving productivity, efficiency, and customer satisfaction.

Customers demand the highest levels of service and support. Service providers must deploy services quicker and ensure quality installations the first time, every time.

The DSAM is designed for your business:

- The all-in-one tester incorporates state-of-the-art DSP and DOCSIS technologies to test cable modem service, digital video, analog video, and VoIP (optional)
- Finds and troubleshoots customer-affecting issues with MACTrak™ and Field View QAM™ over RF and Ethernet interfaces
- Rugged, lightweight design withstands rain, cold, heat, hits, drops, and other accidental mishaps
- A wide range of configurations are available to cover the fundamental needs of installers or fulfillment technicians (DSAM-2000), through the troubleshooting needs of service technicians (DSAM-2300 or DSAM-3300), and to the advanced performance testing needs of network maintenance technicians (DSAM-3300 and -6300)
- A cloud-based, browser-accessible platform manages test activities, maintains an accurate inventory of DSAM meters, and baselines network and technician/contractor performance

The DSAM incorporates state-of-the-art DSP and DOCSIS® technologies to test cable modem services, digital video, analog video, and VoIP. Just one meter lets you test virtually all of your services. There is no need for multiple meters or to change test equipment—even with voice over IP (VoIP) services.

With the DSAM-2000, technicians can certify the cable-modem readiness of homes during routine installations, assuring more reliable customer high-speed data self-installations, thereby reducing future service calls. Service technicians can use the DSAM-3300 to troubleshoot, find, and fix network and service problems. Network maintenance and sweep technicians can use the DSAM-6300 to perform both forward and reverse sweep performance tests as well as support troubled installation jobs with advanced digital and DOCSIS capabilities on the same meter. Users can archive test results from the test site over the DOCSIS connection to a cloud-based test data management system (StrataSync option) and can access the data with a standard web browser.

The automated test capability of the DSAM can be custom configured and protected by administrators to assure that all technicians conduct specified tests the same way. Upgrading the meter can be as simple as downloading a file from the web. Designed for field conditions, the DSAM meters are rugged, reliable, and ready to use by technicians at any skill level. Reduce repeat calls by finding and fixing the problems the first time.

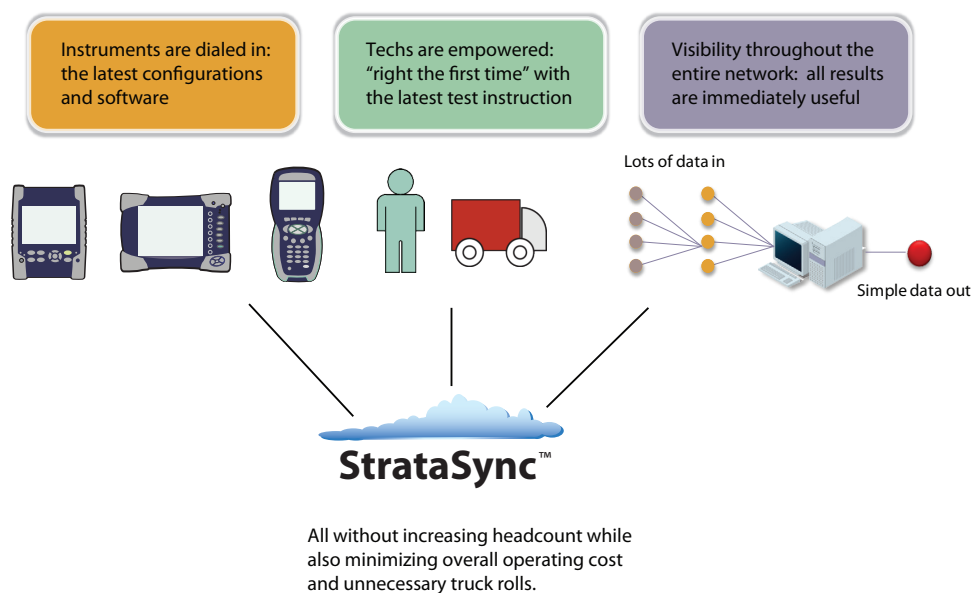

DSAM and other testers integrated with cloud-based StrataSync asset management

## Solutions that Improve Your Bottom Line

Increase productivity and make the jobs of managers and technicians easier and more efficient with the unique functions of the DSAM and StrataSync.

### Enhanced Field Test Management

StrataSync, a cloud-based platform, gives field service supervisors and managers an advanced tool to manage testing activities, maintain an accurate inventory of DSAMs, and baseline network and technician/contractor performance.



StrataSync software lets supervisors easily configure, update, and upgrade DSAM meters in the field. It also lets more knowledgeable technicians remotely control a DSAM in the field.

### Remote RF Synchronization

The DSAM can save technicians 30 to 45 minutes every day with remote RF synchronization that lets technicians synchronize data both ways with StrataSync over the RF plant via a DOCSIS channel. A supervisor or administrator can configure and store DSAM channel plans and pass/fail limit plans in StrataSync for deployment to multiple technicians.

With just one push of the synchronize function on the meter, the technician can synchronize all channel plans, limit plans, and test data with StrataSync. Technicians do not need to physically go to a single PC to synchronize their meters. Alternatively, the technician can connect an Ethernet-configured DSAM to any LAN connection for the synchronization process. The DSAM makes it practical for a large number of technicians to effectively upload test results at the end of the day, every day, or even after every job.

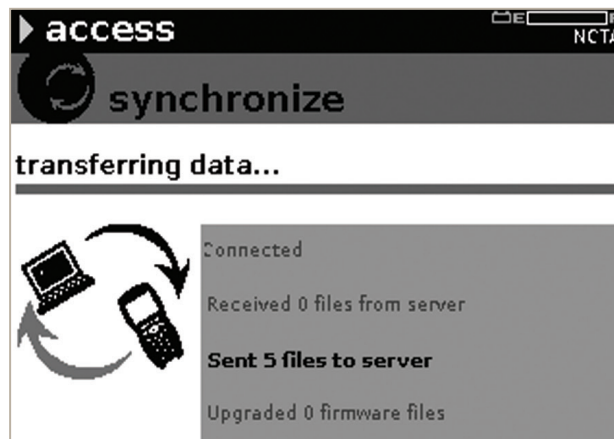

Users can synchronize test files from the field and administrators can update channel plans over Ethernet or DOCSIS RF connections.

### Meter Asset Manager

Monitor meters at a glance with the StrataSync asset manager to quickly determine:

- The number of meters for each version in inventory
- Which field meters have the correct test setups and firmware
- Which technicians routinely synchronize their meters and upload data

StrataSync simplifies DSAM meter test setup configuration. When channel lineups are changed, supervisors can update all instruments with the new channel plan quickly and ensure that technicians are using the correct autotest with the latest limit plan.

### Improved Reporting

The synchronization process and structure of StrataSync also serves as a central repository for valuable field test data. Traditionally, technical operations underutilize test data, including sweep files, because of the difficulty of storage and retrieval, but with StrataSync this data can be easily maintained and retrieved. Retrieval is accomplished using the instrument's synch process or through standard browser access to StrataSync. With a robust database and unique file structure, StrataSync maintains all test data in a single database that managers and supervisors can mine easily for value-added reports.

### Rugged and Reliable

The DSAM's rugged design withstands a 4-foot drop on all sides, and withstands a 75-mph wind-driven rain at up to 4 inches of rain over a 1-hour period. With its lightweight design and ergonomic body, technicians prefer to use the DSAM to other meters. Easy to understand and learn to use with its onboard help system, technicians can quickly use the DSAM with minimal training.

## Designed for Your Technicians

The DSAM family models provide just the right collection of test tools needed for technicians to do their jobs. The DSAM-2000 provides installation technicians with a basic digital and analog signal analysis meter. In addition to quadrature amplitude modulation (QAM) signal analysis, including average power level, modulation error rate (MER), and pre- and post-FEC (forward error correction) bit error rate (BER), the DSAM-2000 measures analog video and audio levels as well as carrier-to-noise ratio. Technicians can confirm DOCSIS connectivity with a simple range and registration test that includes upstream transmit level margin. A manager or supervisor can use StrataSync to configure an autotest plan with a variety of measurements and deploy it to a specific group or to all meters. Initiated with just two button pushes, the autotest performs the same pass/fail test, the same way, at any location, using the latest channel plan.

Service organizations can perform the same measurements with the DSAM-2300 and go further by troubleshooting DOCSIS connections and provisioning issues. With the DSAM-3300, Gigabit Ethernet testing is included as well as full downstream spectrum mode and a QAM constellation display. Technicians can make FEC BER, errored seconds, and severely errored seconds measurements on deep-interleave 256 QAM carriers with all DSAM-2000, -2300, -3300, and -6300 models.

Maintenance organizations use the DSAM-6300, which combines all the DSAM functions with the forward- and return-path Stealth Sweep™ technology (patent No. 5585842) used in the Viavi Stealth Digital Analyzer (SDA) products.

With powerful Stealth Sweep technology, the DSAM-6300 works with existing SDA rack-mounted sweep gear (SDA-5500 and SDA-5510) located at headend and hub sites. Additionally, the DSAM-6300 meters can sweep side-by-side with SDA-5000 meters. Major network modifications are not required.



## DSAM Detailed Feature Matrix

Features	Feature	Model			
		2000	2300	3300	6300
Analog and digital carrier level verification	Analog video and audio power levels	✓	✓	✓	✓
	Digital power level	✓	✓	✓	✓
	Tilt (1 to 12 channels)	✓	✓	✓	✓
	Mini-scan (1 to 12 channels)	✓	✓	✓	✓
	Full-scan (1 to 999 channels)	✓	✓	✓	✓
	Analog carrier-to-noise	✓	✓	✓	✓
	Hum	✓	✓	✓	✓
	SmartScan™	Opt	✓	✓	✓
	Spectrum analyzer with auto pre-amp	Opt	Opt	✓	✓
Digital carrier quality (QAM carriers)	MER/EVM measurements	✓	✓	✓	✓
	Pre- and post-FEC BER (64, 128, 256)	✓	✓	✓	✓
	BER for deep interleave (128,4 or 128,5)	✓	✓	✓	✓
	Constellation (64, 128, 256)	Opt	Opt	✓	✓
	Digital Quality Index™ (DQI)	✓	✓	✓	✓
	AGC stress	✓	✓	✓	✓
	Errored/severely errored seconds	✓	✓	✓	✓
	Equalizer Stress, in-channel response, group delay			Opt	Opt
	QAM Ingress	Opt	Opt	Opt	Opt
Upstream physical verification	Return loopback				✓
	Local upstream spectrum for ingress check	✓	✓	✓	✓
	Return QAM generator	Opt	Opt	✓	✓
	Spectrum analyzer w/auto pre-amp	Opt	Opt	✓	✓
	Field View of the PathTrak return spectrum	Opt	Opt	Opt	Opt
	Field View QAM of PathTrak MACTrack	Opt	Opt	Opt	Opt
	Frequency extension to 110 MHz	✓	✓	✓	✓
DOCSIS/EuroDocsis testing	DOCSIS 2.0/1.1/1.0 testing 1 downstream x 1 upstream	✓	✓	✓	✓
	DOCSIS 3.0 bonded carrier testing 8 downstream x 4 upstream	✓	✓	✓	✓
	Downstream MER/EVM, pre- and post-FEC BER	✓	✓	✓	✓
	Dynamic DOCSIS range and registration	✓	✓	✓	✓
	Cable modem configuration file verification	✓	✓	✓	✓
	Upstream channel selection	✓	✓	✓	✓
	Upstream transmit level and headroom	✓	✓	✓	✓
	Cable modem and CPE MAC cloning	✓	✓	✓	✓
	CableLabs-issued certificates	✓	✓	✓	✓
	IPv6 compatibility — cable modem	✓	✓	✓	✓
Dual MAC/BPI+ certificates	✓	✓	✓	✓	

Features	Feature	Model			
		2000	2300	3300	6300
DOCSIS/EuroDocsis service tests	Packet loss	Opt	✓	✓	✓
	Throughput — upstream and downstream (up to DOCSIS 3.0 rates)	Opt	✓	✓	✓
	Ping	Opt	✓	✓	✓
	VoIPCheck — voice over IP testing (MOS, packet loss, jitter, delay)	Opt	Opt	Opt	Opt
Ethernet testing	Throughput — (DOCSIS 2.0 rates)	Opt	✓	✓	✓
	Packet loss	Opt	✓	✓	✓
	Ping	Opt	✓	✓	✓
	View CM diagnostics page	✓	✓	✓	✓
	Gigabit Ethernet option throughput — (DOCSIS 3.0 rates) up to 400 Mbps down	Opt	Opt	✓	✓
RF network verification	Forward Sweepless Sweep™	Opt	Opt	Opt	✓
	Reverse alignment				✓
	Forward (downstream) sweep				Opt
	Reverse (upstream) sweep				Opt
	Return loopback				✓
HFC network verification	Scheduled autotest	✓	✓	✓	✓
	Proof test	✓	✓	✓	✓
Home network verification	IP tests via 10/100/1000 Ethernet jack	Opt	✓	✓	✓
	Ingress resistance test (IRT)	✓	✓	✓	✓
	Fault location using FDR feature in LST-1700 remote transmitter	✓	✓	✓	✓
	Test point compensation	✓	✓	✓	✓
	SmartID advanced coax probe support <sup>1</sup>	✓	✓	✓	✓
	DSAMobile iPad app	Opt	Opt	Opt	Opt
	WiFi support (USB) <sup>2</sup>	Opt	Opt	Opt	Opt
Autotest	Home certification	Opt	Opt	Opt	Opt
	Video autotest	✓	✓	✓	✓
	Cable modem autotest	✓	✓	✓	✓
	Combination autotest (video and cable modem)	✓	✓	✓	✓
	Proof of performance (scheduled autotest)	✓	✓	✓	✓
	Web browser	Opt	Opt	Opt	Opt
Miscellaneous	RF, WiFi, or Ethernet synchronization with StrataSync	✓	✓	✓	✓
	Secure Sync™ — RF Synchronization through firewalls	✓	✓	✓	✓
	Optical power meter support (USB) MP-60A and MP-80A <sup>1</sup>	✓	✓	✓	✓
	P5000i fiber inspection scope support <sup>1</sup>	Opt	Opt	Opt	Opt
	QAM Egress	Opt	Opt	Opt	Opt
	StrataSync asset management — 1 year subscription	✓	✓	✓	✓

1. Firmware to support this option is standard and requires the purchase of a hardware accessory.

2. Firmware to support this option is optional and requires the purchase of a hardware accessory.

# Features

## Signal Level Meter

The DSAM family performs extremely accurate Viavi digiCheck™ digital power level measurements, as well as traditional SLM test functions for analog video and audio levels. Furthermore, the ability to measure C/N on analog carriers comes standard. Also included are MER and pre- and post-FEC BER as well as errored seconds/ severely errored seconds on 64/256 QAM carriers. These tests allow technicians to verify the reception of digital services within margin and quality specifications. This includes deep interleave modulation (j=128, i=5) on the DSAM-2000, -2300, -3300, and -6300. The DSAM can analyze downstream carriers to a full 1 GHz.

On a digital channel, the level mode measures the signal level and MER, and

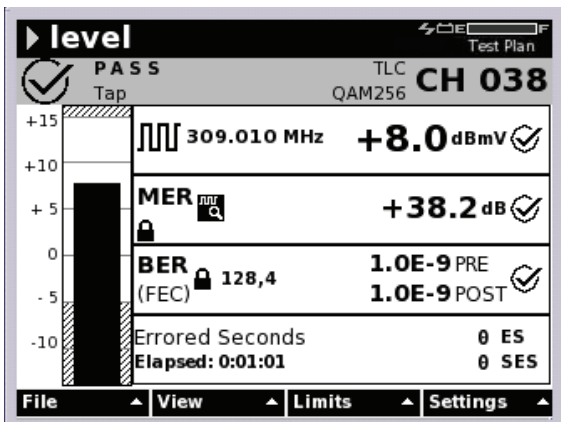

tracks the BER and errored seconds.

## Miniscan and Full Scan Modes

With miniscan and full scan test modes, technicians can see high- and low-frequency digital and analog signals, and with limits activated can easily verify that there is adequate level headroom. In miniscan mode, the DSAM can monitor up to 12 channels at a time. In full scan mode, the DSAM can monitor the entire channel plan, up to 999 channels. The display shows the scan results either as an easy-to-read bar graph or in an informative table.

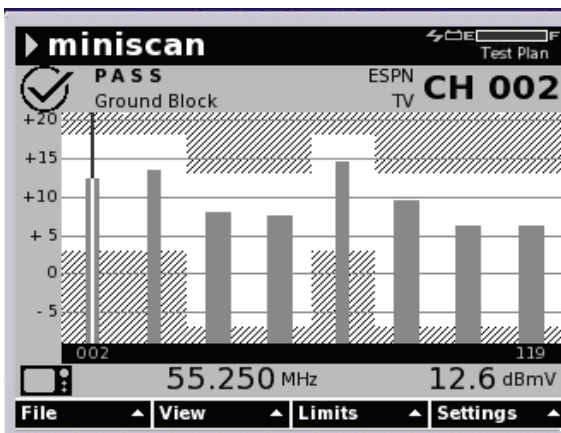

Miniscan measures signal strength of up to 12 channels simultaneously.

## Tilt Mode

Tilt mode shows the forward channel level tilt at the low and high ends of the frequency spectrum. The variances of the levels, displayed at the bottom of the DSAM screen, provide a rough indicator of the degree of amplitude versus frequency distortion. Based on these results, technicians know which equalizer pad to select for optimum flatness at the end of the line.

## Hum Analysis Mode

The hum analysis mode measures hum on non-scrambled analog channels. Because the instrument is battery powered, the measurement is independent of ground loops, isolating it from the line (mains). Severe hum on an analog channel appears on a TV as either single (60/50 Hz) or double (120/100 Hz) horizontal bars across the video screen. The hum display indicates the composite level of all frequency components below 1000 Hz as well as the fundamental hum frequency. A frequency graph displays the lower levels of adjacent frequencies as well as the fundamental. This display is valuable in determining the hum source by displaying a telltale signature of the hum generating source.

## Digital Quality Index™

Unique to Viavi, DQI indicates the overall health of a QAM stream and is helpful for tracking intermittent problems. It is an easy to understand index rating from 0 to 10, with 10 being the highest quality. The measurement's highly sensitive advanced DQI algorithm enables technicians to quickly and easily catch and isolate RF domain problems that are affecting HDTV and HSD services. DQI also catches errors that traditional measurements miss. The measurement results appear on a 180 second historical graph, facilitating the identification of intermittent problems.

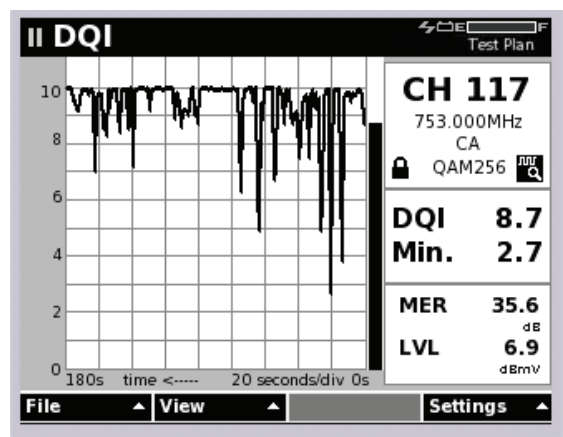

DQI displays intermittent, short duration impairments missed by MER and BER as well as steady state issues typically captured by MER and BER.

## Bit Error Rate Measurement

The BER measurement speeds detection of impulse interference in the system by revealing when information is lost or corrupted at the bit layer. The DSAM measures BER by tracking the number of errored bits detected before FEC, known as pre-BER, and the number of post-FEC uncorrected bits, known as post-BER.

## Errored Seconds and Severely Errored Seconds Measurement

For troubleshooting intermittent bit error suspected connections, technicians use the DSAM to capture errors that have occurred over time. If an error has occurred during any second of elapsed time, the number in the errored seconds field increments by one. When one error or multiple errors occur in the same second, this counts as one errored second. If more than 1 bit in 1 million received bits has errors occurring in the same second, the severely errored second register increments by one. The errored seconds fields are conveniently included in the standard digital level display.

## Constellation Mode

Various elements within a network can compromise digital video quality. Based on the patterns of data points displayed on the DSAM's constellation mode graph, technicians can quickly and easily interpret, detect, and diagnose sources of digital video problems.

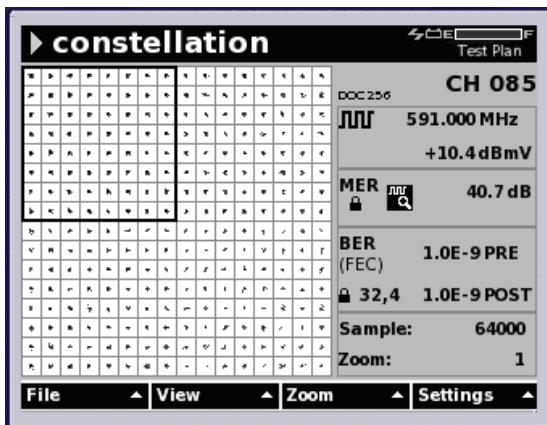

Patterns in the constellation graph display show network impairments. Technicians can figure out the probable cause of the impairment by identifying the pattern.

## Modulation Error Ratio Measurement

Low MER can be the earliest indication of transmission quality degradation resulting from noise, ingress, and composite distortions. An expression of signal-to-noise ratio (S/N) plus all other non-transient distortion signals, MER also shows phase and amplitude distortions that may have been passed from the headend. Viavi has perfected this valuable measurement by optimizing both custom hardware and proprietary software algorithms. The result is measurement accuracy that far exceeds that of customer premises equipment (CPE) embedded diagnostics.

## QAM Sensitivity Setting

The QAM sensitivity setting allows adjustment because all CPE does not function equally. The meter has a configurable high-sensitivity digital setting to provide objective measurements that help technicians track CPE-reported MER/BER issues in the network. The DSAM has a normal mode to measure standard RF network performance as corrected by distortion mitigation technology within the CPE. The high-sensitivity setting turns off the various digital processing technologies that correct for various impairments found on the network, thus revealing pre-correction signal quality. The QAM sensitivity configuration setting is global and affects all MER and/or BER measurement modes, including DOCSIS mode.

## Automatic Gain Control (AGC) Stress Indicator

The AGC stress indicator on a digital channel level measurement icon appears when the DSAM detects rapidly varying AGC levels. This rapid network amplifier AGC variation can cause tiling, blocking, freezing, slow cable modem throughput, and/or packet loss. The AGC stress indicator indicates that there is a network problem upstream from the tap. The AGC stress indicator is viewable in the digital level Autotest and as well as the overall results section.

## dB Delta (intermodulation limit)

The dB Delta measurement compares highest and lowest carrier levels at the test point to determine maximum differential throughout the spectrum. This comparison provides an early indication of potential intermodulation distortion caused by largely different carrier levels overdriving a CPE's tuner, which may result in tiling, blocking, or packet loss. Root causes can include excessive tilt and/or cable loss or excessive power on a given channel. The DSAM integrates this calculation into the Video AutoTest and Home Certification results display.

The DSAM itself can overcome dB Delta situations to provide accurate measurements. The DSAM is configurable to anticipate normal, medium, or high dB Delta conditions to minimize overdriving and allow proper measurements.



### QAM Ingress Mode

Detecting the presence of ingress within digital carriers on the downstream path is nearly impossible without turning off the service. The tightly spaced QAM carriers hide any visual presence of unwanted forward ingress or distortions, such as composite second order (CSO) and composite triple beat (CTB). An MER test will indicate that an issue exists, but with the QAM Ingress mode, technicians can inspect what is actually going on beneath the digital "haystack," while service remains intact. The hardware and/or software option for QAM ingress is available for the DSAM-2000, -2300, -3300, and -6300.

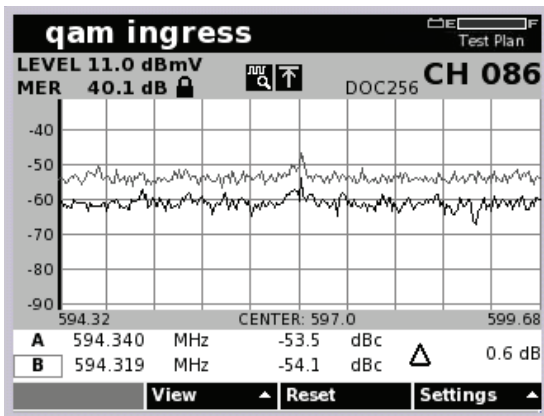

The QAM Ingress test lets technicians see spectrum underneath a live digital carrier which is usually not viewable due to the presence of the "haystack."

### Return QAM Generator

Standard on the DSAM-3300 and -6300, the Return QAM Generator is a mobile 16 and 64 QAM transmitter. The ability to transmit a QAM-16 or -64 modulated signal back to the headend is helpful for proving line capabilities for future data and voice channels and for troubleshooting return path issues in the network. This option, used with the PathTrak™ RPM-3000, can identify network problems and distortions.

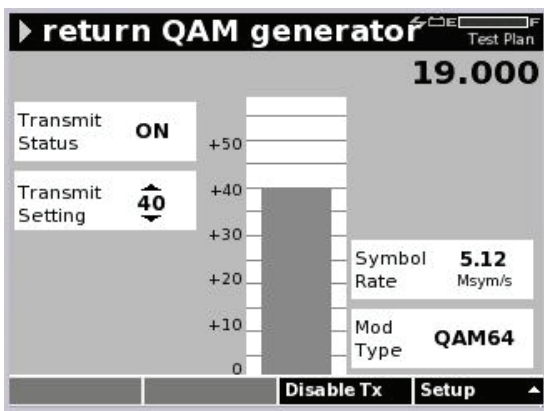

The ability to transmit a QAM-16 or -64 modulated signal back to the headend is helpful for proving line capabilities for future data and voice channels and for troubleshooting return path issues in the network.

### QAM Egress Option

The QAM Egress option provides preset spectrum analysis with a QAM signal identifier that simplifies finding leaks (and verifying fixes) identified by leakage monitoring systems. Also available are an optional directional antenna for locating from a distance, and an optional near-field antenna for close inspection and verification of repair work.

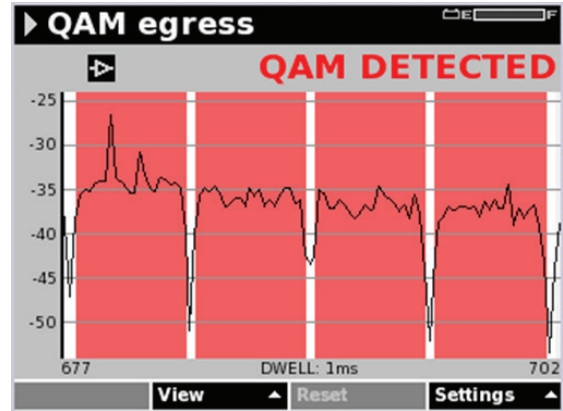

The QAM Egress option simplifies the detection of leaks (and verifying fixes) identified by leakage monitoring systems.

### AutoTest Measurements

The DSAM performs one-button Autotest measurements that let technicians quickly and automatically check combinations of key analog, digital, and/or DOCSIS network parameters. AutoTest may be configured with key autotest measurements including pre- and post-FEC BER, C/N, adjacent channel, hum, dB Delta (intermodulation limit), AGC stress indicator, and the FCC 24-hour Proof of Performance (PoP) AutoTest.

All tests are user enabled per channel, except for adjacent channel information and hum. The user enables chosen channels for hum in StrataSync and the system calculates adjacent channel information on all tests. The user can also schedule Autotests over time. Each channel plan requires its own autotest configuration.

Scheduled tests default to the 6 hour FCC PoP interval, but users can change the interval to fit their needs. With tests scheduled at regular intervals (for example, 15 minutes) technicians can identify disturbances that change based on time of day. The DSAM automatically saves test results into a new user-labeled work folder.

## Location Files

It is important to field technicians to record the location when they are storing test measurements. Location files enable attachment of critical information to saved files for easy sorting and reporting. The technician enters associated location data as prompted when saving the measurement files, and can append the files with information such as work order number, area, amp ID, and power configuration. A single location file (template with default entries that can be modified) per meter will be applied to all saved measurement files. The location categories can be custom edited and deployed using StrataSync.

## Comprehensive Analog and Digital Testing on the Forward Path

The DSAM architecture incorporates digital and analog testing in a single user interface that allows technicians to select a specific channel or a scan of channels without having to differentiate between digital or analog video, DOCSIS high-speed data, or voice. The active channel plan functions as a meter configuration file as well as a channel lineup. An extensive selection of configuration elements establishes the type of tests to perform on each particular channel in the plan.

Also inherent within a given channel plan are Autotest configurations for digital, analog, and DOCSIS services. Users can configure the meter directly or through StrataSync, which manages channel plans and measurement files for a collection of DSAM meters. Networks with a history of multiple ownerships and diverse hardware architectures are not a problem for the DSAM. Supervisors can create multiple channel plans for a specified group of meters or one channel plan for the whole network, and deploy them with parameters locked when needed. Users select specific plans from Configure mode or, in many cases, directly from within Measurement mode. After selecting an active plan, technicians can check the top of the measurement screen to confirm that it is using the correct plan. The channel plan name is included in saved measurement files for reference. A channel plan configured Autotest quickly runs multiple tests with only two button presses.

## SmartScan™

Identifying RF and frequency response issues at the tap can often be difficult for service or fulfillment technicians due to the large differences in acceptable tilt and varying design power levels. SmartScan helps technicians find issues at the tap by providing a simple normalized view that identifies peak-to-valley and tilt issues. Patent pending SmartScan technology provides a simple graphical view that helps eliminate technician interpretation errors and highlights RF response issues by automatically calculating and compensating for tilt and varying channel types. SmartScan peak-to-valley, tilt compensation and individual channel power pass/fail

limits aid technicians in identifying and escalating problems from the tap or drop. SmartScan is optional on the DSAM-2000 and -2300, and is standard on the DSAM-3300 and -6300.

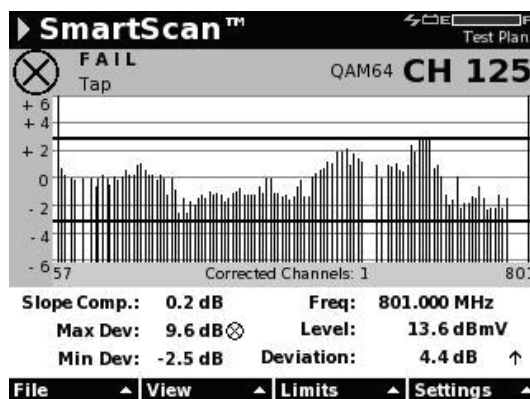

SmartScan provides a simple view to help locate RF issues between the tap and CPE.

## DOCSIS Service Testing

The DSAM has a built-in DOCSIS 3.0-ready cable modem for performing quick and accurate DOCSIS RF and IP tests. Technicians can use the DSAM to test existing DOCSIS 1.X and 2.0 system performance. With the DOCSIS 3.0 option, the DSAM can test a full DOCSIS 3.0 "gold" system complete with 8 bonded downstreams and 4 bonded upstream signals.

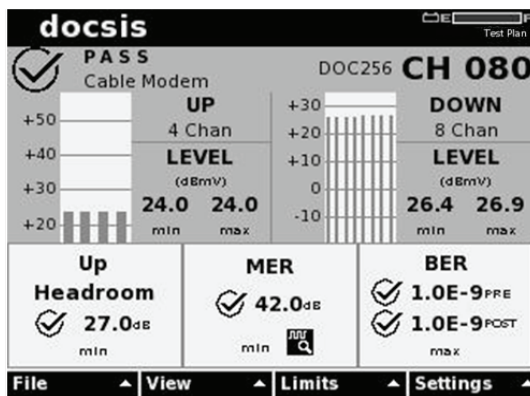

Summary view quickly identifies overall performance.

## Range and Registration

The DSAM can test ranging and registration with the headend cable modem termination system (CMTS) to establish the required configuration parameters and obtain a valid IP address on the network. The DSAM's range and registration test verifies that a specific portion of the line can support high-speed data transmission. Range test results show how much margin remains before either up or downstream communication becomes disabled. Registration test results validate that the CMTS is distributing correct configuration files and IP addresses.

## DOCSIS IP Test

The DSAM performs IP tests, including packet loss, throughput, and ping, over the DOCSIS connection. The displayed results indicate problems that need to be located and fixed and those that should report as headend or IP troubles.

## VoIPCheck Option

With VoIPCheck, the DSAM can test VoIP services independent of the implemented VoIP specification. VoIPCheck can segment RF issues from IP issues, helping to eliminate finger pointing. The measurement displays packet statistics; including packet loss, jitter, and delay, as well as call-quality results such as R-value and mean opinion score (MOS). With its in-depth results analysis capability, the DSAM can determine the source of call-quality problems, expediting the troubleshooting process.

CMTS Loop		CODEC: G.711u		jitter Buffer Size: 150ms	
<b>Packets</b>	<b>Current</b>	<b>Max</b>	<b>Avg</b>		
PacketLoss	0.0%	0.0%	0.0%	✓	✓
jitter	2.1	24.5	2.2	✓	✓
Delay	8.1	33.6	8.5	✓	✓
<b>Quality</b>	<b>Current</b>	<b>Min</b>	<b>Avg</b>		
MOS	4.2	4.2	4.2	✓	✓
R-value	93	93	93	✓	✓

VoIPCheck displays packet loss, jitter, and delay as well as MOS and R-values.

## Forward and Return Path Testing and Maintenance

The cable plant is a two-way communication path. As a vital link between the CPE and the CMTS, the return path alignment and ingress and noise mitigation are key preventive maintenance requirements. With digital services, limiting noise and ingress becomes even more important as service degradation moves in a short range from tiling or bit errors to catastrophic failure.

Designed to test and maintain both the downstream (forward) path and upstream (return) path, the DSAM-6300 provides the optimal approach to maintaining HFC networks, giving technicians the ability to sweep, conduct signal level and quality measurements, as well as analyze ingress and noise.

## Equalizer Option

The DSAM offers an Equalizer option that gives a graphical representation of the DOCSIS receiver equalizer taps. Technicians can use this option to quickly see problems causing reflection. In the level measurement mode, units with this option provide a warning to alert technicians of an equalizer limit issue. Technicians can simply switch to the equalizer mode to see the graph with a marker to

identify the tap exceeding the limitations and then calculates the distance to the reflection source. The mode also displays the in-channel response and group delay for the tuned channel which helps technicians troubleshoot narrowband RF transmission issues caused by suck-outs or diplex roll-off.

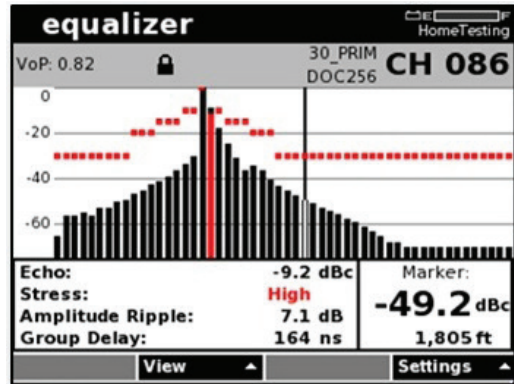

The equalizer tap graph shows reflections and the distance to the source.

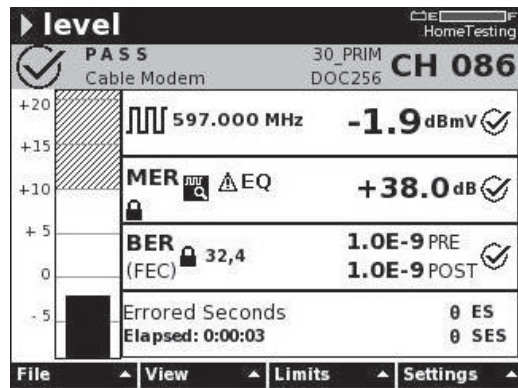

EQ warnings appear in the level mode when tap-related issues exist.

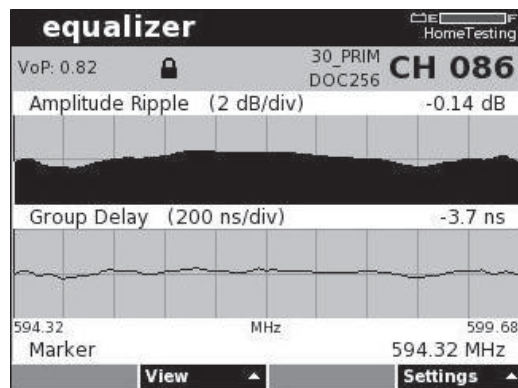

In-channel response and group-delay measurements help technicians troubleshoot narrowband RF transmission issues.

# Applications

## Sweepless Sweep® Mode

The Viavi Sweepless Sweep mode provides an economical solution for service technicians to check forward path alignment and identify frequency response issues. This mode scans the entire forward spectrum, displaying all levels across all frequencies (as defined by meter configuration). Technicians can adjust the reception of the node amplifier with this scan and then normalize the display by saving a reference. The resultant display is a flat zero level trace. Moving the probe to the output test point of the RF amplifier displays any changes due to the amplifier as a deviation (delta) from the reference display. The same reference is used as technicians move down the cascade, thus providing a simple tool to align succeeding amplifiers and compensating for the effects of each cable segment. The Forward Sweep option lets users isolate the effects of headend level changes and provides a more accurate continually referenced sweep. Sweepless Sweep is also useful for aligning portions of the spectrum where there are no active carriers to reference.

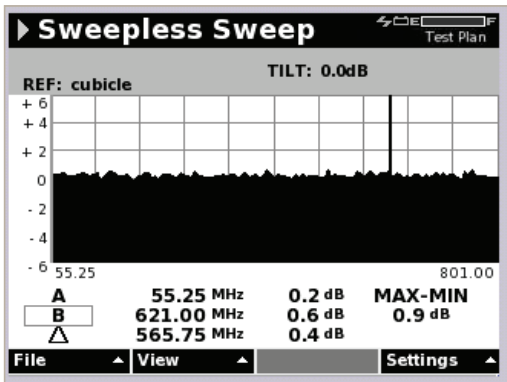

Sweepless Sweep provides a quick method to check cable system integrity using active channels to sweep the forward path. The method does not use inserted sweep points and no forward path headend gear is required.

## Forward Sweep Option

During a forward sweep, existing video carriers (digital or analog) are continuously referenced at the headend or hub site source, eliminating any possibility of unintended and irrelevant variation in the response due to change in any individual signal level at the source.

The DSAM-6300 offers fast forward sweep capabilities, especially in systems with numerous digital channels. In spectrum areas that are densely populated with QAM signals, these signals are referenced in the headend with the SDA-5500 and measured in the field with the DSAM-6300, which eliminates the need for injected sweep signals and avoids any possible interference to subscribers. Continuously referenced sweep provides a more stable and accurate measurement by minimizing the effects of headend level drift.

In unoccupied spectrum areas, the SDA-5500 headend transceiver inserts sweep points at designated frequencies. This is extremely useful for construction and plant extensions up to 1 GHz.

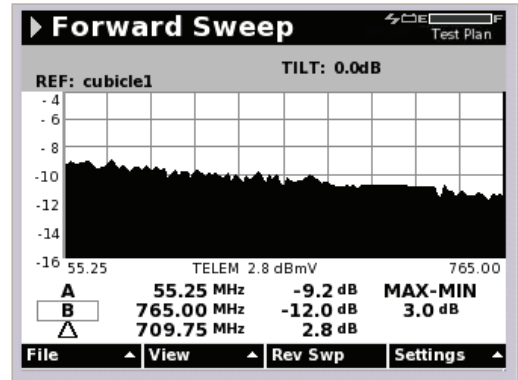

Forward sweep uses a unique referencing method to reveal accurately problems in the system without interfering with any of the analog or digital carriers.

## Reverse Sweep Option

The return path can be problematic and needs maintenance at least as often as the forward path. One of the best practices for preserving a clean return path is to follow an active reverse sweep maintenance plan. The DSAM-6300 has a built-in reverse sweep transmitter, removing the need for a separate instrument to generate test signals. A reverse sweep can uncover mismatch problems, revealed as standing waves, or diplex filter roll-offs that can severely degrade reverse band service quality.

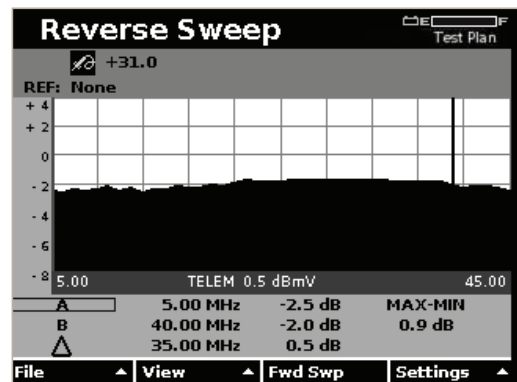

Tight reverse sweep points in the sweep plan display the entire return path with better resolution, and help to find mismatches or other problems in the upstream transmission path.

## Return Alignment

With a DSAM-6300 maintenance technicians can see actual received levels at the SDA-5500 or SDA-5510, providing a simple one-man solution for return alignment. This capability is useful for validating the fiber node return alignment or gain as well as determining overall system loss.

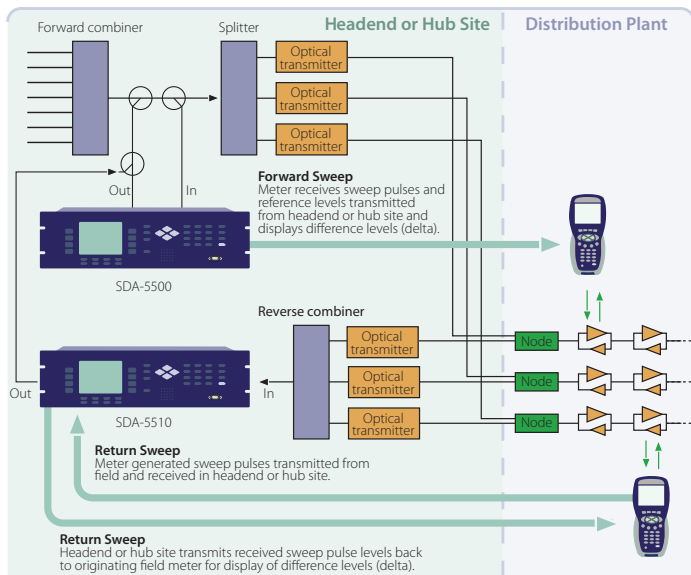

## Return Loopback

Return loopback provides technicians with a quick closed-loop system, in which the DSAM transmits a signal on the output port and receives it on the input port. Technicians can use this capability to check and pre-set the gain on a return amplifier or to validate the loss or performance of a passive device.

## Headend Sweep Equipment

With the DSAM-6300, one person can perform forward (downstream) and reverse (upstream) path alignment simultaneously. For reverse testing with more than one field technician, the rack-mounted Model SDA-5510 Headend Reverse Sweep Manager can perform reverse sweep on the same cluster of nodes for up to 10 different technicians. The SDA-5500 transceiver used in conjunction with the SDA-5510 receiver provides a full forward and reverse sweep alignment solution. The SDA-5510 can also stand alone in remote hub sites for dedicated reverse alignment applications.

## Enhanced Downstream Spectrum

Technicians must be able to view spectrum activity and troubleshoot whether channels have shifted; carriers are missing, or there are in-channel frequency response problems. Because most technicians do not require an expensive full-featured spectrum analyzer, the DSAM, with its enhanced downstream spectrum, provides technicians

with an "everyday" spectrum analyzer. Users can choose between two resolution bandwidths (RBW) settings, 330 kHz or 30 kHz, and modify the amount of time spent measuring each frequency step, also known as the "dwell time" of the analyzer, in settings from 1 to 25 milliseconds. It also lets users see 4 MHz to 1 GHz, in 10 or 50 MHz steps, without switching test modes. Furthermore, when viewing the return path frequencies, technicians can activate an internal low pass filter to eliminate noise caused by the higher frequencies, along with an internal pre-amp, providing a more accurate view of upstream spectrum characteristics.

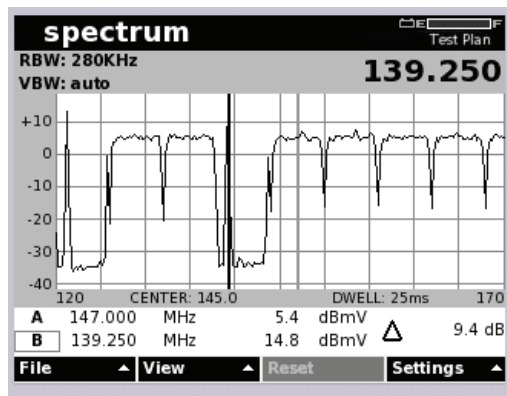

With the DSAM's enhanced downstream spectrum mode technicians are equipped with an "everyday" spectrum analyzer.

## FieldView™ Option

Field View enables communication between the Viavi PathTrak return path monitoring system and DSAMs. A Viavi HSM-1000 sends spectrum measurements from PathTrak to the field meter, where the DSAM displays the results. By comparing local spectrum measurements to those from PathTrak, field technicians can quickly resolve return path ingress problems.

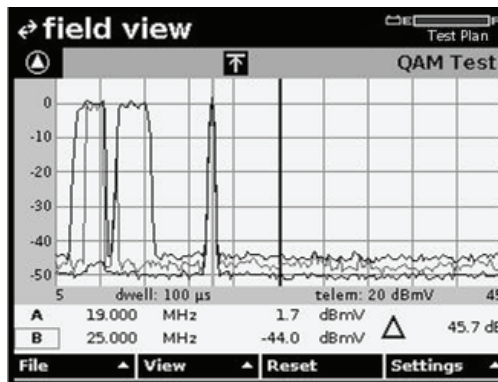

The optional Field View capability greatly improves the success rate and efficiency in locating return path ingress. Field technicians can view the return spectrum as received by the Viavi PathTrak Return Path Monitoring System. The DSAM allows for comparison of the remote spectrum with the local spectrum.

### Field View QAM™ Option

The unique Field View QAM option allows technicians to see upstream impairments that are invisible to spectrum analyzers and sweep tools. Observing a clean spectrum with traditional spectrum analysis tools may indicate a pristine return path; and yet the overall node health reported by the CMTS and other reporting tools shows a low health score, even after teams of technicians have been working on the node cleaning up noise issues for weeks at a time. With Field View QAM, technicians can quickly identify micro-reflections, in-band frequency response, and group delay issues. Armed with the DSAM in conjunction with MACTrak™ technology in the PathTrak, technicians can easily verify the overall health of return path carriers.

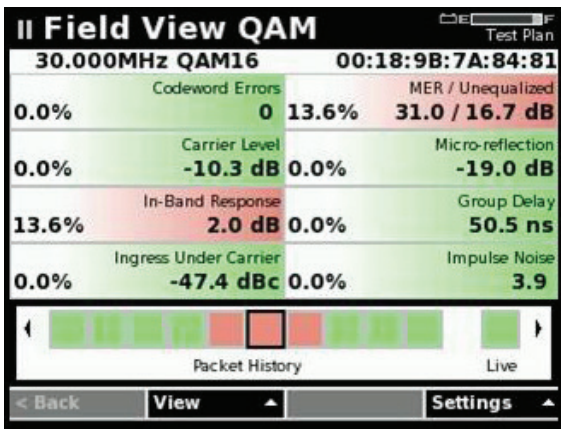

The Field View QAM dashboard shows a variety of measurements for the represented carrier, and indicates by color results outside of user-designated limits. From the dashboard the technician can select a measurement parameter to view more closely and switch directly to a full screen display of that measurement.

### WiFi Option

The WiFi option enables connection of a USB WiFi adapter to verify WiFi network strength and connectivity, or to communicate test data to StrataSync.

### Optical Power Meter Option

The optical power meter option enables connection of a USB power meter (Viavi MP60A or MP80A) for verifying or troubleshooting node light levels.

### P5000i Fiber Inspection Scope

An FBP-series video probe microscope provides the ultimate fiber inspection tool. It fits and operates comfortably and easily in one's hand, letting users inspect hard-to-reach connectors that are installed on the backside of patch panels or inside optical devices. Integration with the DSAM enables a quick inspection of the fiber connection at the node to ensure a clean surface and ensure optimal operation. Combined with a DSAM, this intelligent fiber microscope removes the guesswork from fiber inspection and provides reliable and objective pass/fail analysis of the fibers that connect customers to your network and also provides the best user experience possible.



P5000i Fiber Inspection Scope support lets field technicians “inspect before they connect” to ensure a clean surface and an optimal connection.

### SmartID

Innovative Viavi advanced coax probes enable extremely quick, comprehensive home network qualification, eliminating repeat truck rolls, and making troubleshooting less costly and more effective.

## DSAMobile™ iPad App

An installer technician faces the biggest skills challenge and yet performs one of the most important, integrally strategic tasks impacting long-term customer satisfaction. These technicians need to quickly perform comprehensive tests and assure reliable performance uploading the passing test results to a centralized system (StrataSync). The DSAMobile iPad app offers a simple, intuitive user interface and works with the technician's existing meter (DSAM with XT) to simplify testing and data collection, enabling remote troubleshooting within the home network. It is the only installation iPad app with a WiFi interface, enabling remote troubleshooting throughout the home network. It ties directly into StrataSync, managing home-certification data and automatically synching results, simplifying technician operation. Complete home-certification results can be seen on one screen, shortening troubleshooting time.



The DSAMobile iPad app lets technicians quickly perform comprehensive tests and assure reliable performance.

## StrataSync

StrataSync is a hosted, cloud-based software application that provides asset, configuration, and test-data management of Viavi instruments. StrataSync manages inventory, test results, and performance data anywhere with browser-based ease and improves technician and instrument efficiency.



StrataSync dashboard screen

StrataSync offers:

- Updates to upgrades and options — field personnel operate at maximum capability and efficiency by knowing immediately when firmware upgrades and instrument options are available; they receive proactive, application-aware notifications, and distribution is managed for specific groups and individuals
- Asset and configuration management — user-authored standard templates ensure instruments are aligned to a specific configuration; users monitor and update asset data, modules, configurations, test plans and scripts, templates, and groups, ensuring technicians with the right instrument configurations have increased first-time success rates and reduced repeat rates
- Test-data management — a common test data repository makes baselining performance practical and enables trend analysis for proactive maintenance, improved reliability, and customer satisfaction; StrataSync also performs file storage, printing, and exporting, and provides clear dashboards and basic reports
- What's New@Viavi — instant workforce access to the latest content from Viavi, including release notes and training material, ensures that field personnel are always trained, informed, and updated

## Viavi PLUS™

Viavi PLUS provides a proven set of service solutions that help communications network operators meet the demands of competition, convergence, and complexity. Viavi PLUS leverages test and measurement expertise and leadership to help service providers deploy high-quality, profitable, next-generation telecommunication services.

PLUS Deployment and Support offers comprehensive standard services to ensure commissioning, availability, functionality, and understanding of the Viavi portfolio.

- Hardware support plans
- Calibration—factory and on site
- Express loaner
- Technical assistance
- Managed inventory
- Installation and commissioning services
- Software upgrade services and maintenance
- Product training



PLUS support plans streamline repair, calibration, and loaner processes making support costs predictable and cost-effective while greatly alleviating your administrative burden. Viavi support plans provide peace of mind knowing that your hardware investment is well protected and that your equipment is available, functional, and up to date.

Viavi understands that your support needs vary; therefore, Viavi will work with you to find the right hardware service support plan to fit your needs. Our Gold, Silver, or Bronze support plans provide various levels of support for repairs, calibration, express loaner, advanced replacement, technical assistance, and product training.

Viavi maintains service centers of excellence throughout the world to rapidly and effectively service equipment for our global customer base. These centers can process thousands of pieces of equipment each month that encompass a variety of sophisticated test equipment and instruments. This core competency Viavi offers in conjunction with our nationwide partners ensures coverage of your entire installed base of test equipment and provides you with the highest quality of service.

### **PLUS Gold**

- Product repairs (fault or no fault) including updates of all proprietary engineering changes
- Priority service for all transactions
- Basic or premium technical assistance center benefits
- Basic product training
- Express loaner equipment
- Basic and/or advanced custom training

### **PLUS Silver**

- Product repairs including updates of all proprietary engineering changes
- Product calibrations
- Priority service for all transactions
- Basic technical assistance center benefits
- Basic product training

### **PLUS Bronze**

- Product repairs, including updates of all proprietary engineering changes
- Priority service for all transactions
- Basic product training
- Basic technical assistance center benefits

## Why Viavi?

Viavi has a long history of integrating the high-level functions and advanced technology necessary for maintaining cable networks into scalable hardware and software platforms. Coupling the innovative Signal Analysis Meter (SAM) with award-winning patented Stealth Sweep technology, Viavi delivers sweep meter solutions unequalled in their ability to perform advanced tests and measurements. These capabilities, integrated into the SDA-5000 series of products, soon earned Viavi its current industry-lead position.

Viavi introduced the DSAM when DOCSIS standards pushed the industry to adopt a common technology for delivering flawless highspeed data and IP services. This award-winning, landmark meter integrated the well-known Viavi SAM functions with DOCSIS cable modem elements and a PC-based management and file system. Visit [www.viavisolutions.com](http://www.viavisolutions.com) for more information about DSAM and related products.



Contact Us **+1 844 GO VIAVI**  
(+1 844 468 4284)

To reach the Viavi office nearest you,  
visit [viavisolutions.com/contacts](http://viavisolutions.com/contacts).

© 2015 Viavi Solutions, Inc.  
Product specifications and descriptions in this document are subject to change without notice.  
dsamfam-br-cab-nse-ae  
10143252 900 1014