

SDA-5000 Stealth Digital Analyzer



The Stealth Digital Analyzer (SDA) product family offers a true "One Box" solution for HFC network testing and deployment of digital video, data, and traditional analog services. While preserving the rugged design and industry standard RF sweep technique of its Stealth Sweep System predecessor, the SDA series now adds test features to qualify the network for today's high growth subscriber services. "Find and Fix" tools are included that reduce technician time for the most labor intensive maintenance and troubleshooting assignments, like tracking down reverse ingress, optical node alignment, proof-of-performance testing, and return path alignment. For these demands, the SDA provides advanced QAM analysis (optional), a powerful 5 to 1,000 MHz spectrum display with cable modem analysis (Zero Span), PathTrak™ Field View, and full forward and reverse sweep capability. And with the versatile combination of standard and optional features, the SDA can be customized for both the cable operator's network technology level and budget.

Why Sweep is the Right Solution



The majority of all transmission errors (including digital) are found by measuring the frequency response of the network. Every physical error in the network that influences the transmitted signals will be revealed in the sweep trace. This means the sweep results are independent of transmission methods and formats.

The goal is to transmit all signals with the best noise specifications and the lowest intermodulation distortion. Sweep is the most effective and efficient tool to show the best compromise between the two. In other words, sweep helps technicians setup the right gain versus frequency.

Normalized Sweep

To ensure that network specifications are maintained, starting from the headend to the subscriber, each section of the network has its own set of specifications. A normalized sweep divides the network into easily managed sections. Each of these network sections, with its own set of specifications and quality requirements, can be designated to an individual team or contractor.

- *Digital ready, non-interfering, continuously referenced sweep*
- *Forward and reverse sweep in one hand-held instrument*
- *Optional QAM view provides complete analysis of digital TV and forward cable modem signals*
 - › *Pre/Post FEC BER*
 - › *MER*
 - › *Constellation*
 - › *Exclusive "Ingress Under the Carrier"*
- *Fast, sensitive spectrum analyzer*
- *Cable modem analysis using Zero Span mode provides accurate, in-service, power, and C/N measurements*
- *PathTrak Field View option quickly pinpoints Return Path Noise / Ingress*
- *Automated, 24-hour Proof-of-Performance according to FCC and CENELEC standards*
- *International language*
- *Rugged, weather-resistant, and lightweight*



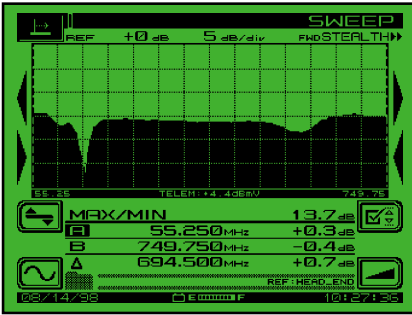

Forward sweep display revealing severe problems at the low frequency end.

The SDA series uses a variation of the original Stealth Sweep technology. Existing video carriers (analog, digital, or scrambled) are referenced when possible, eliminating any possibility of interference to the subscriber services. Where carriers are absent, the SDA-5500 Transceiver at the headend transmits a sweep to fill vacant spectrum areas. To remove effects of headend level drift, the SDA-5500 Transceiver monitors the levels and transmits new reference information with every sweep. This means that if the signal levels are changing in the headend, they won't effect the sweep response measurement. The SDA-5500 Transceiver has all of the measurement capability of the SDA-5000 Receiver, therefore the Headend Technician can keep an eye on headend levels.

The SDA series also offers significantly faster forward sweep speed, especially in systems that include many digital signals. The SDA is capable of referencing 64/256 QAM signal types, so there is no need to worry about subscriber interference or injecting sweep carriers in the guard bands.

Stealth Sweep and SDA Series Sweep Compatibility

The SDA series is completely sweep compatible with Stealth 3SR, 3ST, 3HRV, and StealthTrak SSA-1000 series meters. The only requirement is that firmware version 9.3 is installed in Stealth meters, and firmware version 2.0 installed in StealthTrak SSA-1000 meters. To take full advantage of the faster forward sweep capability, all headend and field instruments must be SDA series.

Preparing the Network for Interactive Services

Reverse Sweep

The SDA-5000 (with OPT 1 installed) allows simple and practical testing of the reverse path frequency response, regardless of the frequency (5 to 1000 MHz). And the SDA has a built-in reverse sweep transmitter, which means externally generated carriers are not required. Furthermore, the SDA-5500 transmitter and field receivers have frequency agile telemetry. They can be configured to communicate on both the forward and reverse paths.

Forward (downstream) and reverse (upstream) path alignment can be performed simultaneously by one person. The operator simply indicates which screen should be displayed—the response from the headend to the test point, or the response from the test point to the headend. A reverse sweep can uncover mismatch problems, which reveal themselves as standing waves, or duplex filter roll-offs that can severely hamper the quality of services in the reverse band.

Multiple User Reverse Testing

For intense reverse testing requirements, the rack mounted Model SDA-5510 Headend Reverse Sweep Manager handles the reverse sweep job for up to ten different technicians on the same cluster of nodes. Using the SDA-5510 in conjunction with the model SDA-5500 Transceiver provides a full forward and reverse sweep alignment solution. The SDA-5510 can also stand alone in remote hub sites for dedicated reverse alignment applications.

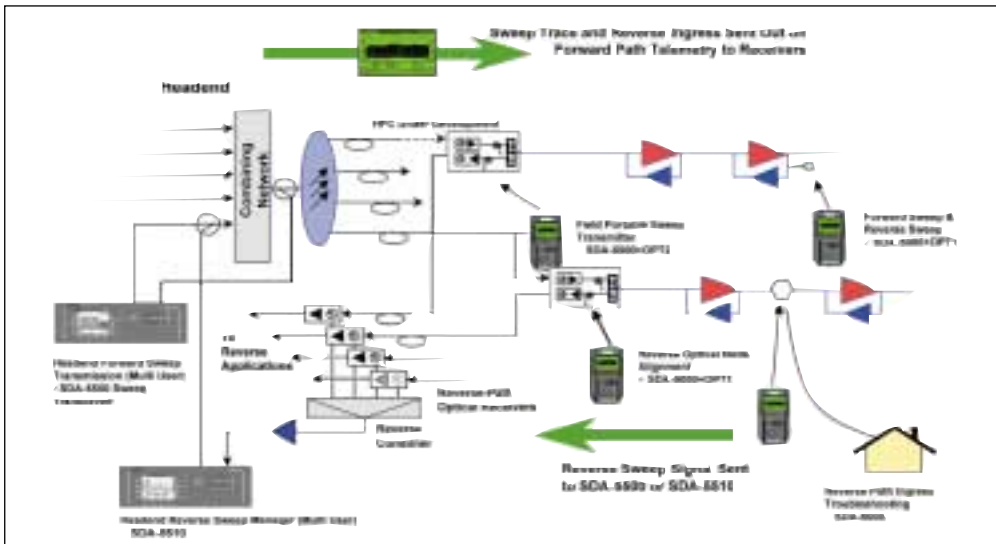

SDA instruments provide a comprehensive set of measurement tools that will follow the expansion of your cable network.

Portable Reverse Sweep Manager

The portable version of the SDA-5510 allows technicians to install a multiple user Reverse Sweep Manager in locations where it is not practical to install a rack mount unit. The SDA-5000 with OPT 6 provides all the functionality of the SDA-5510, but in the rugged SDA-5000 field unit package. Applications include installation in systems where reverse traffic is received by an ATM/SONET/SDH network rather than returning to the headend, or any condition that prevents rack mount installation or access to a headend/hub site (Note: Forward sweep capability not included with SDA-5000 with OPT 6).

Seeing Headend/Hub Site Accumulated Ingress in the Field

The reverse noise feature of the SDA-5000 enables easy reverse path noise testing. The operator simply presses the "Noise" soft key while reverse sweeping, and the display changes to a noise/ingress response indicating the noise level over the entire reverse path spectrum measured at the headend or hub site. All SDA Transmitters provide feedback to the field regarding the current condition of noise and ingress in the headend, even when noise or ingress is "swamping" the telemetry (broadcast mode). A "picture" of the headend noise/ingress is sent out to the SDA Receiver via a special forward telemetry carrier.

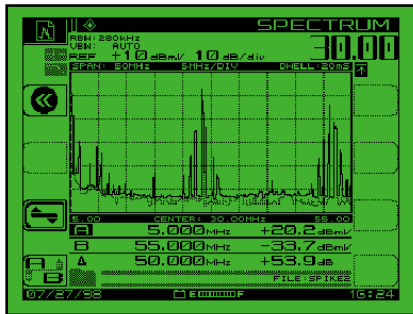

Reverse ingress spectrum display.

QAM View Ensures Quality Forward Path Digital Services

For measurement and analysis of digital TV and forward modem signals, the new digital QAM View option provides a full complement of digital quality measurements. Included is a 64/256 QAM constellation display with zoom, average digital power level, Bit Error Rate (BER), 21 to 35 dB Modulation Error Ratio (MER), and a noise margin "cliff effect" parameter. An equalizer display shows equalizer stress and distance to fault.

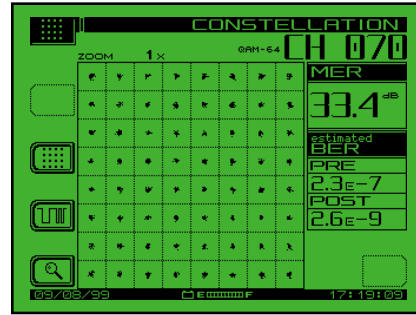

Constellation display with MER and pre/post FEC BER.

In addition, an exclusive noise mode allows technicians to see ingress/noise under an active digital carrier. This tool is invaluable for detecting forward path ingress otherwise hidden by conventional spectrum views!

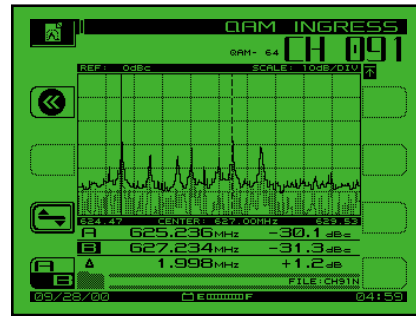

In-service ingress spectrum showing CSTB/CSO-intermodulation problems due to analog-TV channels.

In-Service Cable Modem Analyzer

For "bursty" digital signals such as TDMA technologies used on cable modems for reverse services, the SDA-5000 offers two measurement choices. The first, a one-button cable modem analyzer test, quickly shows carrier-to-noise measurements. The second, an advanced Zero Span feature, utilizes a time domain display to allow power measurements while the modem is in service. Both methods are compatible with global cable modem standards.

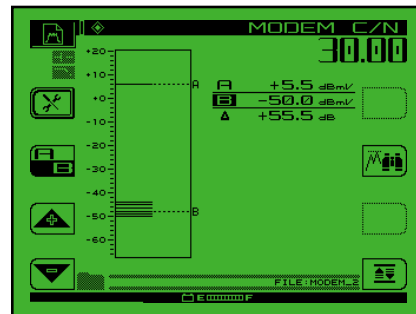

One button, in-service C/N measurements on TDMA return path cable modem signals (DOCSIS, EuroDOCSIS, EuroModem).

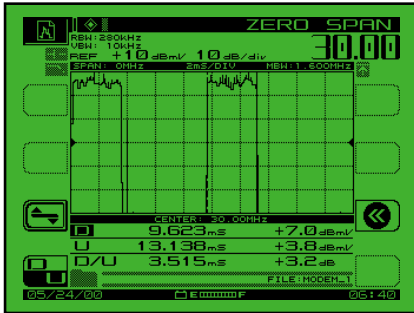

Zero Span/Time Domain Expert mode, showing the TDMA bursty return path cable modem power ramp of 3.5ms.

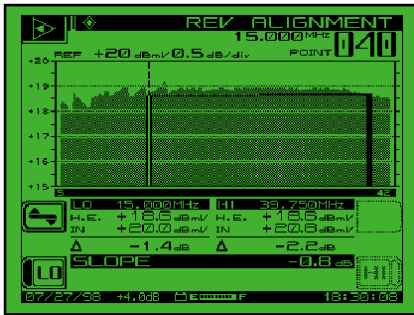

Reverse Alignment mode prepares network for cable modem deployment.

son instantly reveals to the technician whether the ingress source is originating at the current testpoint or at a different location. The comparative spectrum technique slashes noise/ingress troubleshooting time, since the technician can immediately verify whether corrective action performed in the field (local trace) results in improvement in the headend spectrum (remote trace).

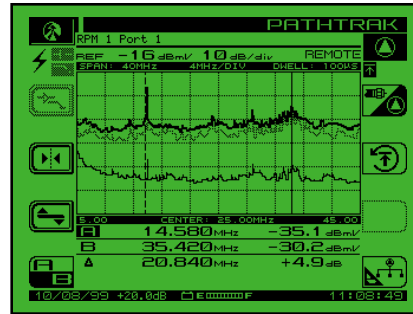

PathTrak Field View option compares headend node spectrum with field testpoint spectrum.



Detecting Ingress in the Field

The operator looks at the ingress present at the field test point using the spectrum display on any of the receivers, then switches to reverse ingress/noise to see the ingress at the head-end for comparison. This time-saving procedure helps in locating sources of ingress. An adjustable dwell time ensures that even intermittent ingress is detected. The preamp and low-pass filter also assures that even low-level ingress is seen. The preamp and low-pass filter on the SDA-5000 assures that ingress can be measured on devices with bi-directional testpoints or testpoint values of 30 dB or more.

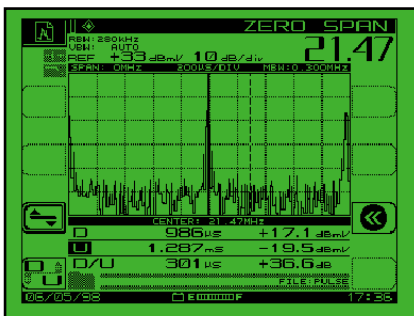

Time domain view of ingress in the Zero Span mode captures elusive ingress.

Powerful Graphic Displays and Common User Interface Allow Technicians to Learn Fast



The results of all measurements are presented to the user in clear, highly informative, summary displays. The graphics present the information the way the technician wants to see the results—no further interpretation required. For example, testpoint compensation values are entered at the start of testing. Displays then calculate actual levels automatically, minimizing field errors.

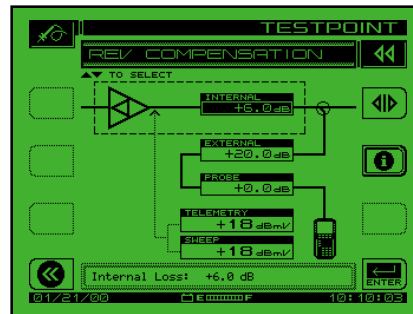

Graphical reverse testpoint compensation.



PathTrak Field View

When a system is equipped with the PathTrak Performance Monitoring System, system technicians can benefit from the ultimate ingress fighting tool—the PathTrak Field View option for the SDA-5000. With Field View, the SDA-5000 receives a return path headend spectrum broadcast from the PathTrak unit and compares it with a return path spectrum at any field testpoint. The side-by-side spectrum compari-

son With SDA series products, all levels of instruments are familiar to the technician, regardless of which is learned first, because the same user interface conventions are used across all product families (several examples of the icons are included in this literature). The learning curve for a progressing technician is considerably shorter than with alternative test equipment. This means urgent upgrade projects make the most efficient use of limited resources when SDA series products are used.



The Navigator user interface, common on all Acterna meters.



Analog and Digital Signal Limits

Analog signal threshold limits have always been a technician's favorite feature of Acterna instruments. Automatic limit checks provide a quick go/no-go status for audio and video levels. The SDA series extends this capability with a dedicated digital limit set that can be applied exclusively to the forward digital carriers defined in a channel plan. By assigning separate analog and digital limits, test time is reduced since no calculation is necessary to determine if analog and digital level relationships are within system specifications. Analog and digital limit capability is available in both the Scan and Autotest modes.

Comprehensive Testing

The SDA provides an extensive set of signal analysis features designed for proving, and improving, network quality. All tests utilize a practical user interface, normally requiring only the push of a button.



Level Measurement

The SDA instruments have a comprehensive single-channel level display that indicates tuned channel, video frequency and level, audio frequency and level, and the difference between video and audio carrier levels.

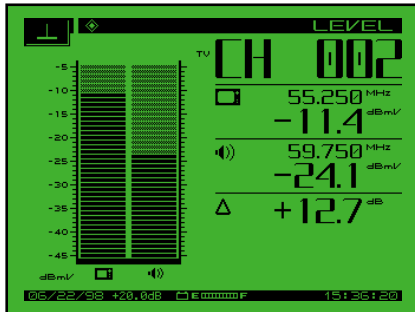

The single-channel level display shows both video and audio levels (either single or dual sound/NICAM) and the difference between the two.



Tilt Measurement

Tilt is the easiest and most efficient tool for balancing amplifiers. For cable plants requiring multiple tilt measurements, such as comparing today's tilt measurement with a historical record and then taking an additional measurement for a new wider channel plan, the technician simply uses markers to indicate the tilt channels that define the new limits.

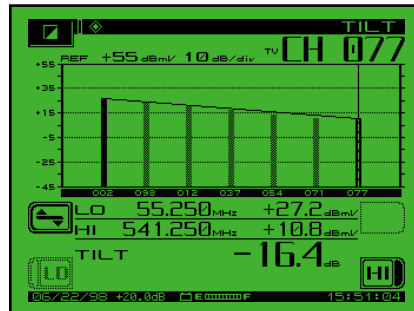

Tilt mode performs automatic tilt calculations between any two of nine designated carriers.

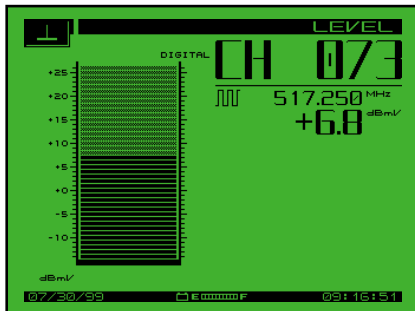

Digital channel average power measurements can be made using the digiCheck™ feature.



The CTB/CSO mode is used for automatically making intermodulation measurements.



Scan Measurement

Scan mode provides a quick graphical view of the entire channel plan with bars representing the video level for each channel. Both video and audio may be displayed.

Making accurate digital average power measurements is addressed with the digiCheck measurement function. The digiCheck feature is compatible with most "non-bursty" digital modulations in use today (i.e., 16, 32, 64, and 256 QAM, QPR, QPSK, VSB, CAP16, etc.).

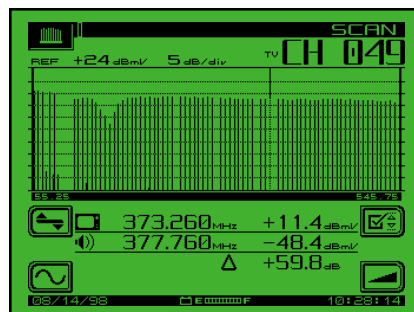

Limit checks can be instantly viewed after identifying channel of interest with a marker in Scan mode display.



Carrier-to-Noise Measurement: In-Service

Taking carrier-to-noise measurements (on a non-scrambled channel) is easy. There is no need to remove modulation from the video carrier, and a tunable preselector filter is not needed.

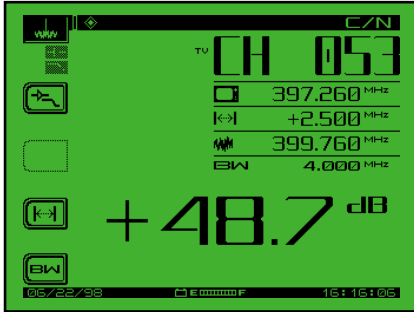

In-service carrier-to-noise.



Hum Measurement: In-Service

Measuring hum on a channel (non-scrambled) is as simple as pressing the "HUM" key. Since the instrument is battery powered, the measurement is independent of ground loops and is, therefore, isolated from the line (mains). Hum is revealed as either a single (60 Hz) or double (120 Hz) horizontal bars across the video screen. The level of either can be measured.

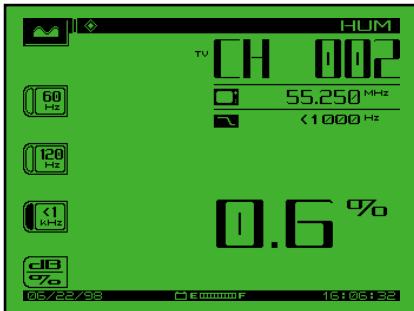

In-service hum (PAL/NTSC compatible).



Modulation Measurement

Includes NTSC, PAL, and SECAM formats. Demodulation of the audio is done for both AM and FM. FM is used to hear audio distortion on the FM radio channels or the sound of the TV program. AM is used to recognize short-wave interference signals in the reverse band.

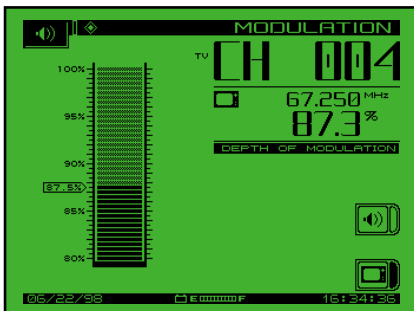

Depth of modulation.



Local Amplifier Alignment w/Loopback Tests

The SDA loopback tests allow the technician to quickly perform frequency response measurements of active or passive field devices using a single meter. Either a CW or sweep signal may be generated from the SDA unit and injected to the input of a device under test. The DUT output can then be measured by the SDA, providing valuable information such as gain, loss, roll-off, or frequency response. The CW loopback test is available on the SDA-5000 when ordered with OPT 1. The CW loopback and sweep loopback features are available on the SDA-5000 when ordered with OPT 2.

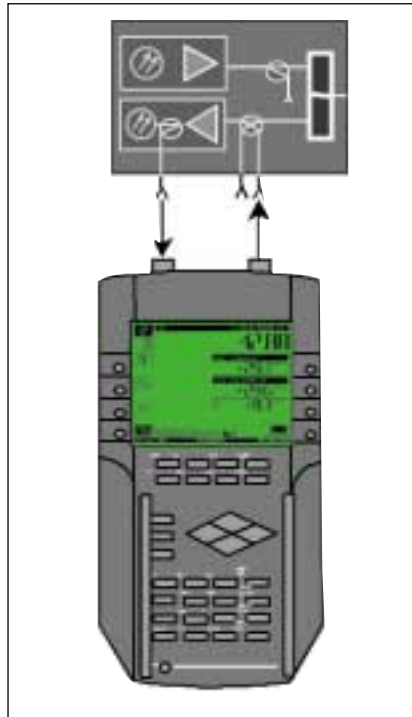

Local Loopback Sweep: Performs initial setup of optical nodes or measuring the gain or loss of individual components in the field.

Extensive Automated Test Capability

Automated tests can be scheduled to perform either 24-hour FCC compliance tests, or initiated immediately to log performance at individual nodes, amplifiers, or other testpoints. A wide range of tests can be performed automatically, including signal levels, C/N, hum, and depth of modulation. The operator designates which tests to perform on which channels. Because these tests are non-intrusive, it is easy to test all parameters on all channels at anytime.

After a test is performed, the results can be displayed on the SDA screen. A pass/fail indication on a variety of limits can be set for FCC/CENELEC or other government standards, or to system preferences. Data taken during any automated test, or sequence of automated tests, can be viewed immediately with a pass/fail indication for each of the limits. Specific stored measurement results may be viewed on demand. Automated test results can be printed directly to a serial printer or uploaded to a PC using StealthWare to store and include in custom reports.

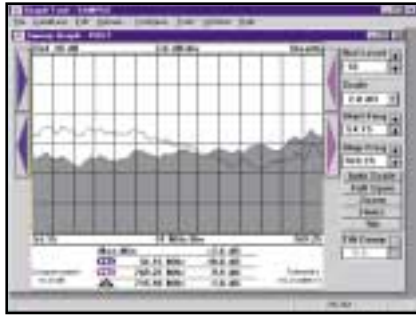

Detailed forward/reverse sweep graph offers adjustable markers, scale, reference level and tilt. Users can clearly distinguish between previous and current sweep measurements for easy comparison on PC StealthWare display.

Data Analysis with StealthWare

Any stored SDA measurement information can be uploaded to a PC using StealthWare, a Windows™ based data management package. Stored sweep, scan, or spectrum screens can be viewed on the PC and analyzed with marker movement and readout information just the same as on the actual unit. A sweep graph overlay function allows comparison of multiple RF response variations over time. Old sweep graphs may be downloaded back into the SDA instrument for real-time comparison.

“One Box” Solution

How many test instruments should the network maintenance technician carry? One. A lightweight, rugged, and affordable meter with the versatility to test the latest digital services while maintaining the analog spectrum. This "One Box" philosophy shaped the design of the SDA series, adding the analog and digital test tools most requested by field technicians and system operators throughout the world.

Analog Testing

- Forward RF Sweep
- RF Level, Fast Scan, Tilt
- In-service Carrier-to-Noise, Hum, Depth of Mod.
- Fast Spectrum Display with CTB/CSO
- Auto Testing/24-Hour Testing (FCC and CENELEC Compliant)

Return Path Testing

- Reverse RF Sweep
- PathTrak Field View (Option)
- Reverse Alignment Mode Prepares Network for Cable Modem Deployment
- Zero Span Spectrum Mode
- DOCSIS/DAVIC Compatible Cable Modem Analysis

Advanced Digital Testing

- digiCheck Average Power
- QAM View Digital Analysis with MER, Pre/Post FEC BER, Constellation, and Exclusive Noise/Ingress Under the Carrier Measurement

Upgrading from Stealth to SDA Series

A company's test equipment investment is protected through the Acterna upgrade program. Any model 3SR, 3ST, or 3HRV can be upgraded to the SDA series at any of our worldwide service centers. And customers who own a model SSA-1000 can upgrade to the SDA series with an in-the-field firmware change only!

Start with any **SAM 4040 or 4040D**
Optional: PathTrak FieldView (4040D)

a) Firmware b) Hardware & Firmware

SAM 4040D OR **SAM 4040**

Upgrade to **SDA-4040D**
Standard: DigiCheck ZeroSpan Dig Spectrum
Optional: PathTrak FieldView
Add **Option 4** for: QAM View

SDA-4040D
QAM View option

Any Stealth can upgrade to **SDA-5000** for:
5 x faster sweep
256 QAM compatible sweep
Improved TP Comp setup for reverse sweep

a) Firmware b) Hardware & Firmware

SSA-1000 OR **3SR**

SDA-5000 units can be purchased with, or upgraded to:
QAM View
PathTrak Field View

SDA-5000
QAM View option

Any 3ST can be upgraded to **SDA-5500** for faster forward sweep and digital signal sweep compatibility

3ST
3HRV

Any 3HRV can be upgraded to **SDA-5510**

SDA-5500
SDA-5510

Stealth to SDA Series—Product Upgrade/Replacement Guide

Stealth Model	SDA Replacement
3SR	SDA-5000
3SR + 3SRV option	SDA-5000 with Option 1
3SR + 3SRT option	SDA-5000 with Option 2
3ST	SDA-5500
3HRV	SDA-5510
SSA-1000	SDA-5000 with Option 2 (firmware only)
SAM 4040	SDA-4040D
SAM-4040D	SDA-4040D (firmware only)

Customer Support

Acterna offers quality, cost-effective support programs that address all technical support needs. With over 20 fully equipped CATV accredited service centers worldwide, Acterna provides local product maintenance, calibration, and upgrades, along with technical training services.

CarePlanSM Customer Support Package

The Acterna CarePlan is a proactive technical support program designed to safeguard a company's investment in Acterna's products throughout their life cycle.

Key Benefits of the CarePlan Include:

- Cost-effective product maintenance support
- Annual calibration certification program
- Proactive hardware and software upgrades
- Technical support

Technology Training

Acterna provides a comprehensive CATV technology training program designed to help teams of technicians understand the changing needs of today's advanced networks.

Training Seminars Include

- HFC Basics
- Sweep and Balance Forward and Return
- Sweep 101 "Bootcamp"

Application Features

APPLICATION	FEATURE	SDA-5000	SDA-5500	SDA-5510
Full frequency response testing	Forward sweep mode using headend transmission	•	•	
Reverse path alignment for new digital services	Reverse Sweep mode	•		
Prepare for cable modem deployment	Reverse Alignment mode	•		
View return distortion and ingress as captured at headend	Reverse ingress/noise PathTrak Field View option	•	•	
Reverse path ingress troubleshooting	Built-in low-pass filter and preamp, dwell time	•		
Handle multiple reverse path sweep tests at one time	Multiple user reverse sweep reception (up to 10 simultaneous users)			•
Pro-active reverse path maintenance capability	PathTrak Field View option	•		
Forward sweep without headend support	Sweepless Sweep using carrier levels only	•		
Forward path sweep carrier transmission	Forward transmission of sweep carriers	•	•	
Quick scan of active channel plan	SCAN mode w/limit check	•	•	•
View local distortion and ingress	Spectrum Display	•	•	•
View and measure cable modem carriers on return path (DOCSIS/DAVIC)	Zero Span TDMA Time Domain mode	•	•	•
Test forward path digital services	digiCheck and QAM view option	•	•	•
CSO/CTB measurements	CSO/CTB mode	•	•	•
Amplifier checks and alignment	TILT mode	•	•	•
Local Amplifier and optical node alignment	CW Loopback (opt. 1 or 2) Sweep Loopback (opt. 2 only)	•		
In-service Carrier-to-Noise measurement	C/N mode	•	•	•
Analog and digital level measurements	LEVEL mode digiCheck mode	•	•	•
Depth of modulation measurements	MOD mode	•	•	•

Specifications

FREQUENCY

Range	5 to 1000 MHz
Accuracy	±10 ppm at 25°C; ±10 ppm drift over temp; ±3 ppm/year aging
Resolution Bandwidths	30, 280 kHz and 2 MHz (30 kHz for CTB/CSO only)
Tuning Resolution	10 kHz
Sweep Resolution	250 kHz maximum

LEVEL MEASUREMENT

Range	-40 to +60 dBmV
Resolution	0.1 dB
Accuracy	±1.0 dB from -20 to +50°C ^{1,2}
Log Linearity	±0.5 dB ¹
Flatness	±0.5 dB ³
Signal Types	CW, single carrier, video (single or dual audio/NICAM), audio, digital
Uncertainty for Digital Carrier	additional ±0.5 dB (digital types 16/32/64/256 QAM, QPR, QPSK, VSB, CAP-16, DVB/ACTS and TDMA using zero span spectrum mode) @280 kHz RBW

CARRIER-TO-NOISE⁴

In-service measurement. Non-scrambled channels only. No preselection required for 78 channels or less. Best dynamic range at +10 dBmV or higher input.

Range	≥ 52 dB ¹
Resolution	< 0.5 dB

HUM MEASUREMENT

In-service measurement. Carrier > 0 dBmV. Non-scrambled channels only

Range	0 to 10%
Resolution	<0.2%
Accuracy	±0.7%

DEPTH OF MODULATION

Assumes presence of white reference on any VITS line. Non-scrambled channels only. Audio demodulation of AM and FM carriers

Range	80 to 100%
Resolution	<0.5% at 85%
Audio Demodulation	AM and FM Carriers

TILT MEASUREMENT

Up to 9 pilot carriers or video channels with tilt and level measurements on the highest and lowest.

Hi-Lo Δ Resolution	0.1 dB
--------------------	--------

SCAN MODE

All video, audio, pilot carrier, and digital channel levels displayed.

SWEEP MODE

SDA-5000 and 5500 only

Frequency Range	5 to 1000 MHz
Display Span	user definable
Display Scale/Range	6 vertical divisions 1, 2, 5, or 10 dB/division
Sweep Pulse Occupied Bandwidth	30 kHz
Stability	±0.5 dB, normalized (dependent on stability of referenced carriers)
Sweep Rate	~1 second (78 channels, including scrambled and digital signal types)
Channel Plan Templates (user editable)	China-1; China-2; France; HDTP-NL; Ireland; Japan; Jerold; Jerold-HRC; Jerold-IRC; NCTA; NCTA-HRC; NCTA-SUB; NCTA-IRC; NTSC-Broadcast; OIRT-D/K; PL-B/G; PAL-UK

SPECTRUM MODE

Spans	3, 5, 10, 20, and 50 MHz (0.3, 0.5, 1, 2, and 5 MHz/div.)
Sweep Rates	~1 second updates with spans of 50, 20, 10 and 5 MHz ~1.7 second updates with 3 MHz span
Display Scaling and Range	0.5, 1, 2, 5, and 10 dB/div. 6 vertical divisions
Dwell	programmable 0-25 ms
Spurious Free Dynamic Range	60 dB ³
Sensitivity Without Preamp	-40 dBmV 5 to 550 MHz -35 dBmV 550 to 1000 MHz
Sensitivity With Preamp	-50 dBmV 5 to 550 MHz -45 dBmV 550 to 1000 MHz
Max. Level With Preamp	+50 dBmV

ZERO-SPAN MODE

Video BW	>1 MHz, 100 kHz, 10 kHz, 100 Hz
Resolution BW	2 MHz, 280 kHz, 30 kHz
Measurement BW Compensation	programmable 1 kHz to 99 MHz
Pulse Measurement Accuracy	nominal level in 10 μs ±2 dB from nominal in 5 μs (>1 MHz VBW, 280 kHz RBW)
Sweep Times	100 μs to 20 s (1,2,5 settings)

INTERMODULATION DISTORTION (CSO/CTB)

Range ⁵	≥ 60 dB
Resolution	0.1 dB

FORWARD TRANSMITTER

SDA-5000 with OPT 2/SDA-5500 only

Frequency Range	5 to 1000 MHz
Output Level	+20 to +50 dBmV adjustable in 2 dB increments
Spectral Purity	Hars -30 dBc Spurs -35 dBc

REVERSE TRANSMITTER

Requires SDA-5000 with OPT 1 or 2

Frequency Range 5 to 1000 MHz
 Output Level +20 to +50 dBmV, adjustable
 in 2 dB increments
 Spectral Purity Hars -30 dBc; Spurs -35 dBc

TELEMETRY

Frequency Range 5 to 1000 MHz
 Modulation FSK, 100 kHz deviation
 Spectrum Required . . . 1.0 MHz vacant bandwidth recommended
 Spectral Purity Hars -30 dBc; Spurs -35 dBc

DATA STORAGE

Files stored: Autotests, tilt, channel plans, scan and forward sweep. Also reverse sweep and reverse amp alignment on SDA-5000 with OPT 1 and/or 2. Spectrum mode (regular with max hold and CSO/CTB). Allocated on demand. The storage capability is simultaneous—more of one file type can be "traded" for less of another. All files stored as database, not as screen picture. (Example: Typical mix of files for 78-channel plan: 8 channel plans, 16 sweep references, 80 sweep traces, 40 scan files, 20 spectrum displays and 20 autotests).

SERIAL INTERFACE

RS232; Epson, IBM, Seiko, and Diconix Printers

INPUT CONFIGURATION

Connector Type 75Ω Type F Female
 (Optional 75W Type BNC Female)
 Maximum Sustained Voltage AC 100V DC 140V

GENERAL

Display 320x240 dot matrix LCD, selectable back light
SDA-5000 only
 Dimensions 15.2 x 27.9 x 8.9cm
 (6" x 11" x 3.5")
 Weight 2.3 kg (5.1 lbs)
 (with OPT.1 or 2, 2.5 kg, 5.5 lbs)
 Temperature Range Operating -20 to +47°C (-4 to 117°F)

SDA-5500 and SDA-5510 only

Dimensions 48.3 x 13.3 x 35.6cm
 (19" x 5.25" x 14")
 Weight 6.8 kg (15 lbs)
 Temperature Range Operating 0 to +50°C (32 to 120°F)

POWER SOURCES

Battery Field extended-life replaceable, nickel metal hydride
 12V/3.5A-hr, 4 hours cont. use on a single charge
 AC Line (SDA-5000)
 Charger Input 100 to 250 VAC, 50 to 60 Hz, 0.5A
 Charger Output Aux out 16V @ 750 mA
 Charge 15V @ 750 mA
 AC Line (SDA-5500) 100 to 265 to 63 Hz ~100 VAC
 47 to 63 Hz ~100VA

NOTES

- 1) Typical Specifications
- 2) Relative to 25°C
- 3) @25°C and +20 dBmV

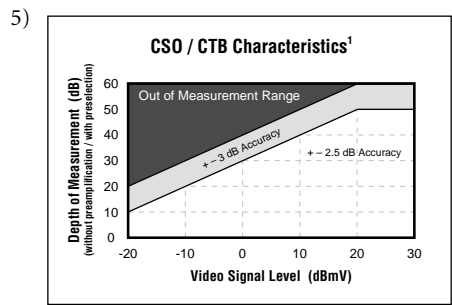
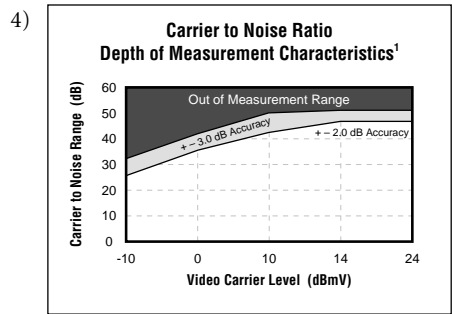

PATHTRAK FIELD VIEW (OPT 3 REQUIRED)

SDA-5000 and SDA-5500 only

Update Rate 2x/second (remote trace)
 ~1x/second (local trace)
 Display Scaling5/1/2/5/10/20 dB/div.
 Selectable Nodes 14 (selectable via PathTrak HCU)

QAM VIEW OPTION (OPT 4)

The QAM View Option can be factory installed in any new or existing SDA Series instrument. The specifications and features are in addition to the standard measurement features of the SDA Series. When ordering, please specify OPT 4A for 8 MHz, DVB-C, ITU-T J.83 Annex A, or OPT 4B for 6 MHz, DVS-031, ITU-T J.83 Annex B.

MODULATION TYPE

. 64/256 QAM, DVB-C, ITU-T J.83 Annex A (OPT 4A)
 64/256 QAM, DVS-031, ITU-T J.83 Annex B (OPT 4B)

CHANNEL BANDWIDTH

8 MHz (OPT 4A); 6 MHz (OPT 4B)

MEASURABLE INPUT RANGE (LOCK RANGE)

64 QAM -20 to +50 dBmV (typical)
 256 QAM -15 to +50 dBmV (typical)

FREQUENCY TUNING

50 to 860 MHz (Digital QAM mode)

Resolution 50 kHz

BER (BIT ERROR RATE)

64 QAM Pre-FEC/OPTs 4A and 4B 10^{-4} to 10^{-9}

64 QAM Post-FEC/OPTs 4A and 4B 10^{-4} to 10^{-9}

256 QAM Pre-FEC/OPT 4A and 4B 10^{-4} to 10^{-9}

256 QAM Post-FEC/OPT 4A and 4B. 10^{-4} to 10^{-9}

MER (MODULATION ERROR RATIO)

64 QAM / Option 4A. 22 to 35 dB

Accuracy ± 2.0 dB (typical, see chart below)

64 QAM / Option 4B. 21 to 35 dB

Accuracy. ± 1.5 dB

256 QAM / Option 4A. 28 to 35 dB

Accuracy. ± 2.0 dB (typical, see chart below)

256 QAM / Option 4B 28 to 35 dB

Accuracy: ± 1.5 dB

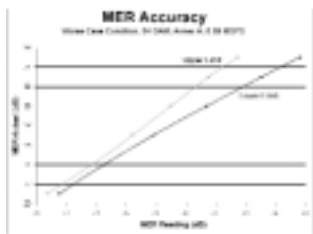

EVM (ERROR VECTOR MAGNITUDE)

64 QAM / Option 4A 1.2% to 5.2%

Accuracy. $\pm 0.5\%$ (1.2% to 2.0%)

$\pm 1.0\%$ (2.1% to 4.0%)

$\pm 1.4\%$ (4.1% to 5.2%)

64 QAM / Option 4B 1.2% to 5.8%

Accuracy. $\pm 0.5\%$ (1.2% to 2.5%)

$\pm 1.1\%$ (2.6% to 5.8%)

256 QAM / Option 4A 1.1% to 2.5%

Accuracy. $\pm 0.6\%$

256 QAM / Option 4B 1.1% to 2.5%

Accuracy. $\pm 0.5\%$

QAM LEVEL MEASUREMENT

Signal types 64 QAM, 256 QAM

Range -20 to +45 dBmV

Accuracy. ± 1.0 dB

Flatness. ± 0.5 dB

Linearity. ± 1.0 dB

Temperature ± 0.5 dB (typical)

MEASURABLE QAM INGRESS

64 QAM. -25 to -40 dBc

256 QAM. -30 to -40 dBc

Accuracy. ± 3.0 dB

GRAPHIC DISPLAY

Digital summary (including MER/EVM, Pre/Post FEC BER, Equalizer Stress, Carrier Offset, Symbol Rate) with limit/margin test results, QAM level. IQ constellation with zoom. Adaptive Equalizer Display (in accordance with the DVB ERT 290 Standard), Frequency Response, Group Delay. Ingress/Noise Under the Carrier.

POWER SOURCE

Note: Option powered from SDA Series nickel metal hydride battery. Operating time is specified for continuous use in QAM View mode. Option includes high output charger.

Charge Time ~4 hours

Operating Time 2.5 hours continuous use (typical)

Universal AC Charger/Adapter

Input. 100-250 VAC, 50 to 60 Hz, 0.5A

Output Charge15V @ 750 ma

PHYSICAL

(total SDA-5000 size with OPT 4)

Dimensions.

15.2 x 26.7 x 10.8 cm

6" x 10.5" x 4.25"

Weight. Approx. 3.5 kg (7.7 lbs)

Operating Temperature Range -20 to 45°C (-4 to 113°F)

Ordering Information

Model SDA-5000

1010-00-0473

Forward and reverse sweep field receiver with advanced signal analysis. Compatible with older Stealth units running firmware version 9.3. Includes: Extended-life nickel metal hydride battery, universal charger/AC adapter, and operators manual

Model SDA-5500

1010-00-0470

Headend Sweep Transceiver: Provides forward sweep and single user reverse sweep for SDA-5000. Compatible with older Stealth units running firmware version 9.3. Includes: Line cord, channel plan transfer cable, and operators manual

Model SDA-5510

1010-00-0472

Headend Reverse Sweep Manager: Receives reverse sweep from up to 10 SDA-5000 receivers with OPT 1 or 2 installed. Compatible with older Stealth units running firmware version 9.3. Includes: Line cord, channel plan transfer cable, and operators manual

Options

1019-00-1286

SDA-OPT1: Reverse Sweep capability for model SDA-5000

1019-00-1285

SDA-OPT2: Reverse sweep capability and 5 to 1000 MHz transmitter for model SDA-5000

1019-00-1290

SDA-OPT3A: PathTrak Field View interoperation for model SDA-5000 or SDA-5500 (PathTrak HCU)

1019-00-1287

SDA-OPT4A: 64/256 QAM, DVB-C, ITU-T J.83 Annex A. QAM View digital analysis including 64/256 Constellation, MER, Pre/Post FEC BER, and exclusive QAM ingress under the carrier feature. Please specify OPT version 4A or 4B when ordering

1019-00-1288

SDA-OPT4B: 64/256 QAM, DVS-031, ITU-T J.83 Annex B. QAM View digital analysis including 64/256 Constellation, MER, Pre/Post FEC BER, and exclusive QAM ingress under the carrier feature. Please specify OPT version 4A or 4B when ordering

1019-00-0460

SDA-OPT5: BNC connectors replace standard F type connectors

1019-00-1295

SDA-OPT6: Portable Reverse Sweep Manager converts SDA-5000 to hand-held version of the SDA-5510 (does not include forward sweep capability)

1010-00-0340

StealthWare: Windows compatible data management software for all SDA, Stealth, MicroStealth, and CLI products



Optional Accessories

1019-00-1298

SDA-CASE1: Replacement soft carrying case for all SDA instruments without QAM View option installed. Compatible with standard and extended-life batteries

1019-00-1190

SDA-NIMH: Spare extended-life battery

1019-00-1195

SDA-NIMCA: Universal charger/AC adapter for extended-life nickel metal hydride battery

1012-00-0057

SDA-NIMK: Extended-life battery kit. Includes extended-life battery, universal charger/AC adapter, and soft carrying case (SDA-CASE1)

Note: Specifications, terms, and conditions are subject to change without notice.

© Copyright 2001 Acterna, LLC. All rights reserved. Acterna, The Keepers of Communications, and its logo are trademarks of Acterna, LLC. All other trademarks and registered trademarks are the property of their respective owners.

CN1001640201AE

Regional Sales Headquarters

Global Headquarters

20400 Observation Drive
Germantown, Maryland 20876-4023 USA
Toll Free 1-800-638-2049
Tel +1-301-353-1550
Fax +1-301-444-8468
www.acterna.com

North America

20400 Observation Drive
Germantown, Maryland 20876-4023 USA
Toll Free 1-800-638-2049
Tel +1-301-353-1550
Fax +1-301-444-8468

Western Europe

Arbachtalstrasse 6
72800 Eningen u.A.
Germany
Tel +49 7121 86 2222
Fax +49 7121 86 1222

Latin America

Av. Eng. Luis Carlos Berrini
936 8/9. Andar
04571-000 Sao Paulo, SP
Brazil
Tel +55 11 5503 3800
Fax +55 11 5505 1598

Eastern Europe, Middle East & Africa

Elisabethstrasse 36
PO Box 13
2500 Baden
Austria
Tel +43 2252 85 521 0
Fax +43 2252 80 727

Asia/Pacific

42 Clarendon Street
PO Box 141
South Melbourne, Victoria 3205
Australia
Tel +61 3 9690 6700
Fax +61 3 9690 6750

1st Neopalmovskiy Per. 15/7 (4th floor)
119121 Moscow
Russia
Tel +7 095 248 2508
Fax +7 095 248 4189



Acterna is present in more than 80 countries. To find your local sales office, go to www.acterna.com



CHEETAH, WWG AND TTC ARE NOW ACTERNA. TO LEARN MORE, VISIT WWW.ACTERNA.COM