

MINOLTA

CHROMA METER CL-100

OPERATION MANUAL **E**

[Konica Minolta CL-100 Specs](#)
Provided by www.AAATesters.com

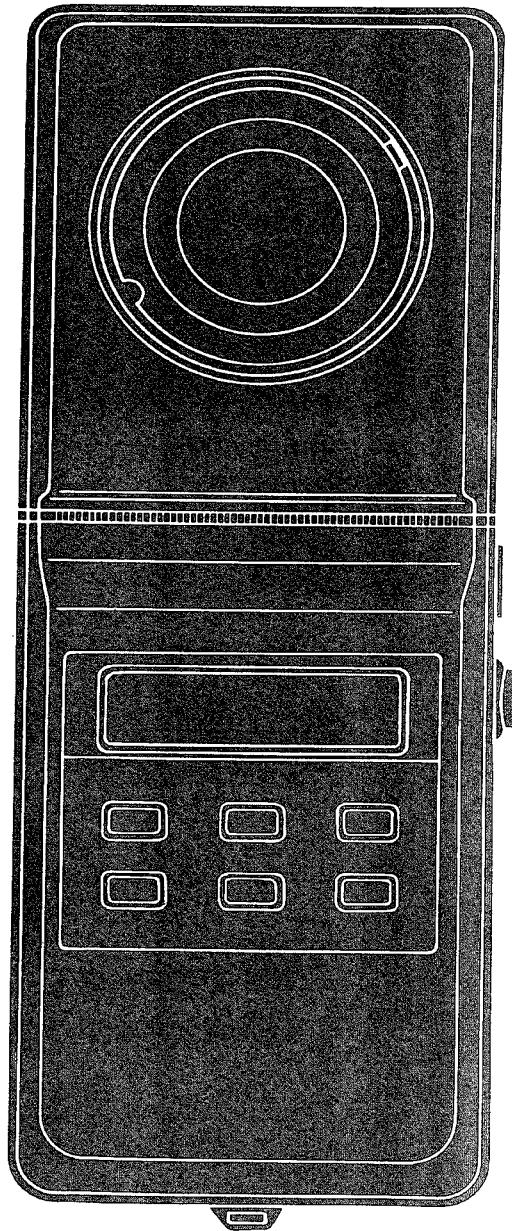

CHROMA METER CL-100 AND ACCESSORIES

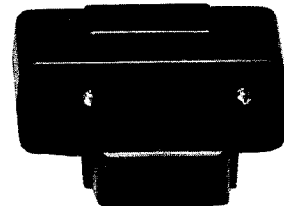
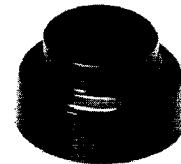
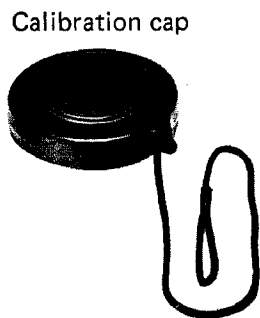
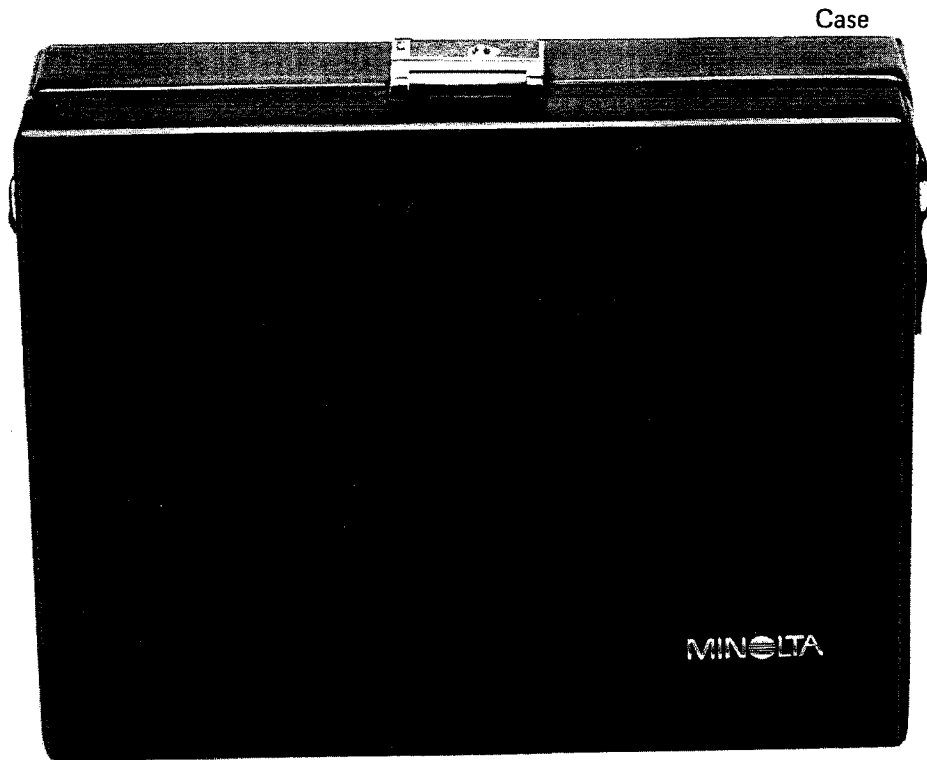

The Minolta Chroma Meter CL-100 (Chroma Meter II Incident)* is the most compact and lightweight tristimulus color analyzer on the market for measuring light source color. For utmost accuracy, it utilizes three high-sensitivity silicon photocells filtered to match CIE (Commission Internationale de l'Éclairage) Standard Observer response. These cells make simultaneous readings of the light source through an integrating diffuser. Readings are processed by the built-in microcomputer and presented digitally on the custom-designed liquid-crystal display. The meter precisely controls measuring time of 100.0 milliseconds for measuring continuous or flickering light sources, such as a CRT.

The hand-held, easy to use Chroma Meter CL-100 is ideal for on-the-spot quality control. Since measurements require only a few seconds, the meter is ideally suited for high-volume applications in both production and laboratory use. Reference colors and calibration standards can be inputted to memory and recalled at any time. The meter can be calibrated to the user's desired standard, and a number of meters can be unified by calibrating to the same standard. The unit is operable by remote control using the included plug. For hard-copy or video presentation, readings can be transferred to a separate data processor through the output cord also included with the meter. Chromaticity is measured in Yxy (CIE 1931) and Yu'v' (CIE 1976); color deviation can be measured in $\pm\Delta(Yxy)$, $\pm\Delta(Yu'v')$ and $\Delta u'v'$.

The Chroma Meter CL-100 is powered by a single nine-volt battery for approximately 30,000 individual readings. As the meter is constantly on and ready, there is no need for warm-up before taking measurements. An automatic cancelling feature clears the display approximately three minutes after a measurement is taken or the last key is released.

Included with the meter are many accessories, such as a CRT-reading hood for measuring cathode-ray tubes, turn adapter for reverse attachment of the receptor head, remote-control plug, data-output cord, calibration cap for easy calibration, plus case and strap.

Before using the Minolta Chroma Meter CL-100 for the first time, please read and study this manual thoroughly. Keep it for later reference as needed.

*Chroma Meter II Incident has been renamed Chroma Meter CL-100.
Specifications remain the same.

CONTENTS

| | |
|--|----|
| NAMES OF PARTS | 2 |
| FUNCTIONS OF KEYS | 3 |
| BATTERY | 3 |
| Installing battery | 3 |
| Power consumption | 3 |
| ZERO CALIBRATION | 4 |
| MEASURING MODES | 4 |
| OVER- AND UNDER-RANGE WARNINGS | 4 |
| CIE 1931 (x,y) – Chromaticity Diagram | 5 |
| Portion of the 1931 (x,y) – Chromaticity Diagram | 6 |
| CIE 1976 (u'v') – Chromaticity Diagram | 7 |
| MEASURING CHROMATICITY | 8 |
| MEASURING COLOR DEVIATION | 8 |
| Measuring and memorizing reference color | 9 |
| Setting and memorizing reference data | 9 |
| Measuring color deviation | 9 |
| Reference color data recall | 10 |
| CALIBRATING METER TO USER'S STANDARD | 10 |
| Calibrating meter | 10 |
| Unifying meters | 10 |
| Calibration data recall | 10 |
| DATA OUTPUT | 11 |
| Example data-output program | 13 |
| CRT-READING HOOD | 14 |
| DETACHABLE RECEPTOR HEAD | 14 |
| TURN ADAPTER | 14 |
| CARE AND STORAGE | 14 |
| TECHNICAL DETAILS | 15 |

NAMES OF PARTS

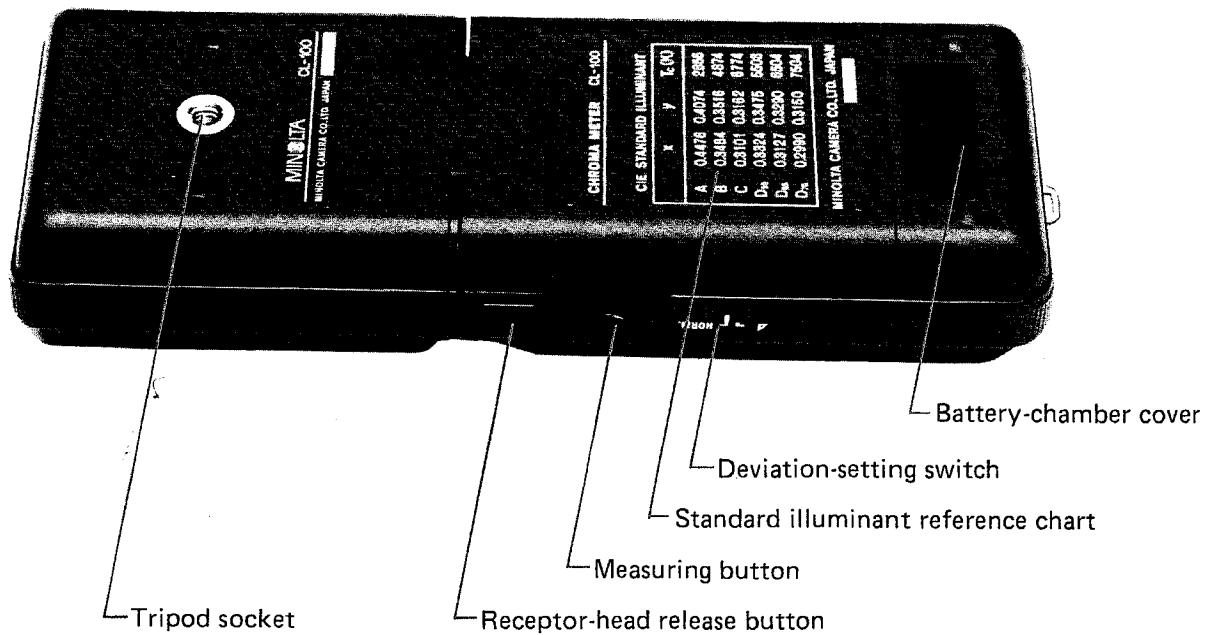
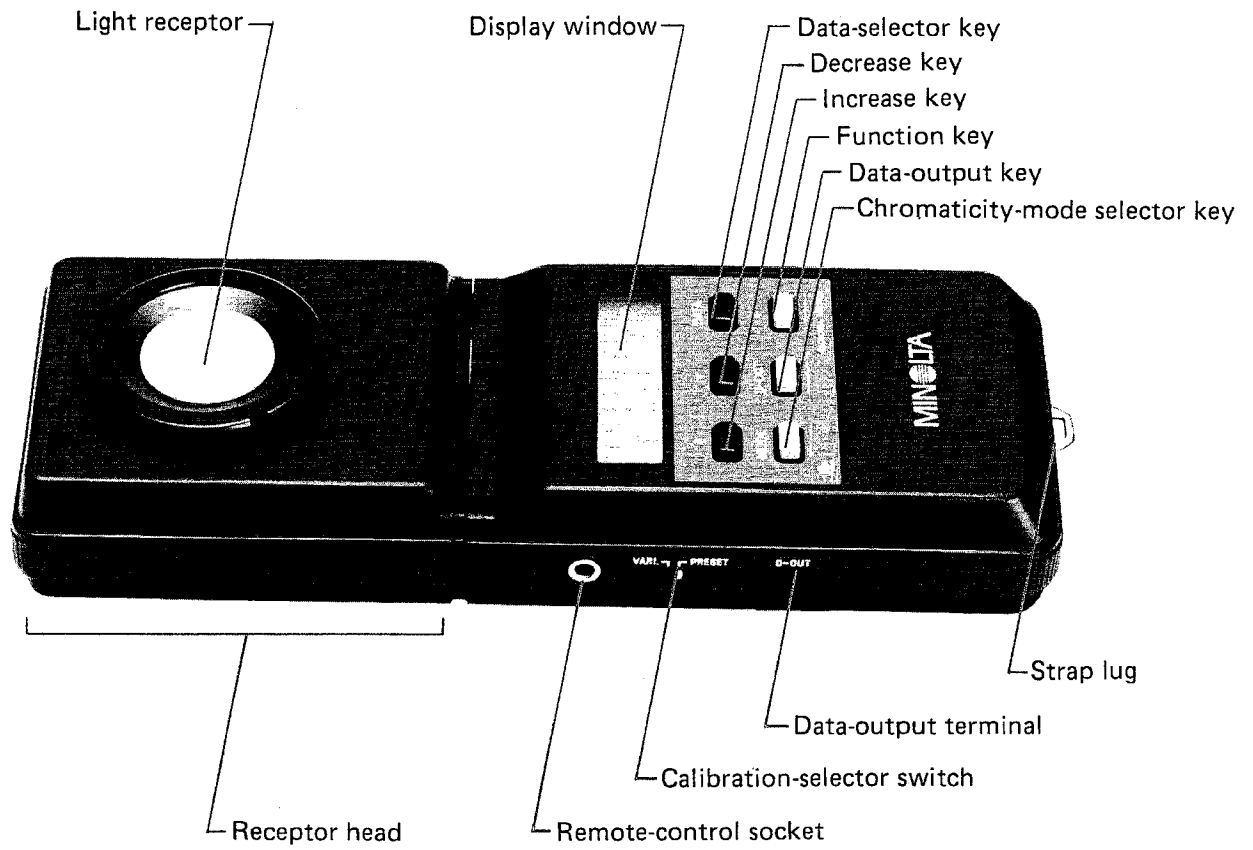

FUNCTIONS OF KEYS

F Function key

Press to release built-in safety lock (which prevents accidental data-changing) and hold down while pressing other keys so they can perform their designated functions; hold down key when sliding switches to input data to memory.

↑ Increase key

In data-setting mode with **F** held down, press key to increase numerical value of data on display; number increases by one each time key is pressed, increases rapidly when key is held down.

↓ Decrease key

In data-setting mode with **F** held down, press key to decrease numerical value of data on display; number decreases by one each time key is pressed, decreases rapidly when key is held down.

MODE Chromaticity-mode selector key

With **F** held down and deviation-setting switch at "NORM.", selects chromaticity-measuring modes, shifting each time key is pressed, or once per second when key held down, in following cycle: $Y_{xy} \rightarrow Y_{u'v'}$ → $\Delta u'v' \rightarrow \dots$

With **F** held down and deviation-setting switch at " Δ ", selects color-deviation measuring modes, shifting each time key is pressed, or once per second when key held down, in following cycle: $\pm\Delta(Y_{xy}) \rightarrow \pm\Delta(Y_{u'v'}) \rightarrow \Delta u'v' \rightarrow \dots$

NOTE

- For color-deviation measuring modes $\pm\Delta(Y_{xy})$ and $\pm\Delta(Y_{u'v'})$, only "Yxy" and "Yu'v'" appear on the display.

ATA Data-selector key

With deviation-setting switch at " Δ " and calibration-selector switch at "PRESET" or "VARI.", press key to enter data-setting mode; values for Y_{xy} can be adjusted for memory input; pressing key displays data in the following order: $Y_{xy} \rightarrow Y \rightarrow x \rightarrow y \rightarrow \dots$

With deviation-setting switch at " Δ " and calibration-selector switch at "PRESET" or "VARI.", press key to recall reference color data in memory.

With deviation-setting switch at "NORM." and calibration-selector switch at "VARI.", press key to recall user's calibration data in memory.

OUT Data-output key

Press to output data.

BATTERY

The Minolta Chroma Meter CL-100 is powered by a single nine-volt "transistor-type" battery (Eveready 216 or equivalent).

Installing battery

1. Remove the battery-chamber cover by pressing down on and sliding it in the direction of the arrow on the cover.
2. Position the battery terminals as illustrated inside the chamber, then insert the battery, bottom end first.
3. Replace the cover by realigning and sliding it towards the meter body until it snaps securely into place.

If the battery has been installed properly, the display will show the following:

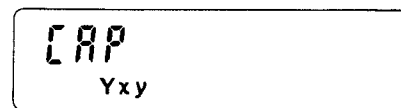

NOTE

- If the battery is reversed, the display will remain blank and the meter will not operate.

Power consumption

Although there is a constant power supply to the memory, the meter's power consumption in the non-measuring mode is minimal, so a power switch is not necessary. Instead, the meter employs an automatic cancelling feature that clears the display approximately three minutes after a measurement has been taken or the last key has been released. When taking measurements, if the display is off, be sure to press **MODE** first to make the display reappear. If this is not done, the first measurement will not be accurate.

The meter's low power consumption permits a fresh battery to yield approximately 30,000 measurements under normal conditions (as determined by Minolta's standard testing method).

When the battery's power level drops to a level almost insufficient for operation, the display will show the following when the measuring button is pressed:



If the battery is totally exhausted, the display window will remain blank after pressing the measuring button.

ZERO CALIBRATION

Zero calibration must be performed before measurements. Do not calibrate when the display is blank. Press [MODE] first, then zero calibrate.

To calibrate:

1. With "CAP" registering in the display window (as just after installing battery), place the black calibration cap over the light receptor.
2. Press the measuring button. Zero calibration will be completed in a few seconds and the display will read:

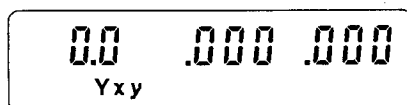

The zero calibration value remains in memory until the battery is removed. For applications where highest precision is needed, the meter should be calibrated each time it is used.

NOTE

- If the calibration cap is removed before calibration is completed, "E" will appear on the display. In this case, repeat the calibration procedure.

MEASURING MODES

Color as perceived has three dimensions: hue, chroma, and brightness. Chromaticity includes hue and chroma (saturation), specified by the x and y coordinates in the CIE (Commission Internationale de l'Eclairage) Chromaticity Diagram (page 5). Since this two-dimensional diagram cannot describe a specific color completely, a brightness factor (Y) must also be included to identify a sample precisely.

The Chroma Meter CL-100 offers five measuring modes selectable according to your needs. Chromaticity-measuring modes are Yxy and Yu'v'; color-deviation measuring modes are $\pm\Delta(Yxy)$, $\pm\Delta(Yu'v')$, and $\Delta u'v'$.

In the Yxy measuring mode, x and y correspond to chromaticity coordinates of the CIE Chromaticity Diagram; Y is illuminance, measured in lux.

In the Yu'v' measuring mode, u' and v' are based on the Uniform Chromaticity Scale (UCS) in which equal distances on the diagram represent approximately equal visual distances; Y represents illuminance. u' and v' are described by the equations below:

$$u' = \frac{4x}{-2x + 12y + 3} \quad v' = \frac{9y}{-2x + 12y + 3}$$

The color-deviation measuring mode $\Delta u'v'$ is expressed by the following equation:

$$\Delta u'v' = [(\Delta u')^2 + (\Delta v')^2]^{1/2}$$

Example displays for each measuring mode are shown below:

Chromaticity

Yxy

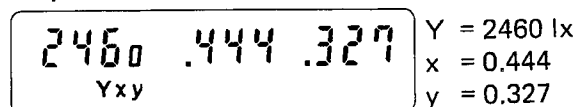

Yu'v'

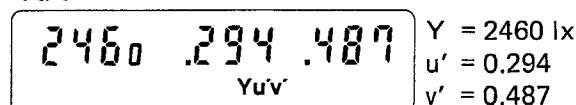

Color deviation

$\pm\Delta(Yxy)$

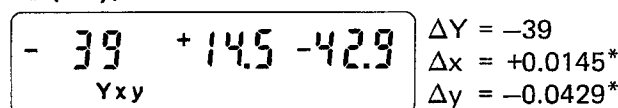

$\pm\Delta(Yu'v')$

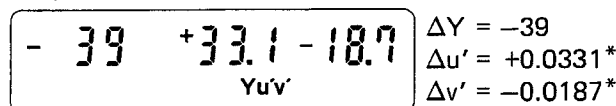

$\Delta u'v'$

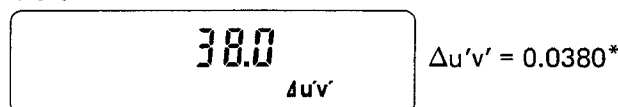

*for actual value, displayed value is multiplied by 10^{-3} ; meter calculates value to the ten thousandths' place (10^{-4})

OVER- AND UNDER-RANGE WARNINGS

If the illuminance level of the light being measured exceeds or falls below the meter's range (5.1 – 32,700lx), the display will give the following warnings:

Over range



Under range

whole display blinks

In the color-deviation measuring modes, if the deviation for a value is equal to or greater than ± 0.100 , it is out of display range and "E9" will appear for that value as shown in the example below:

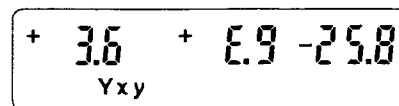

CIE 1931 (x,y) – Chromaticity Diagram

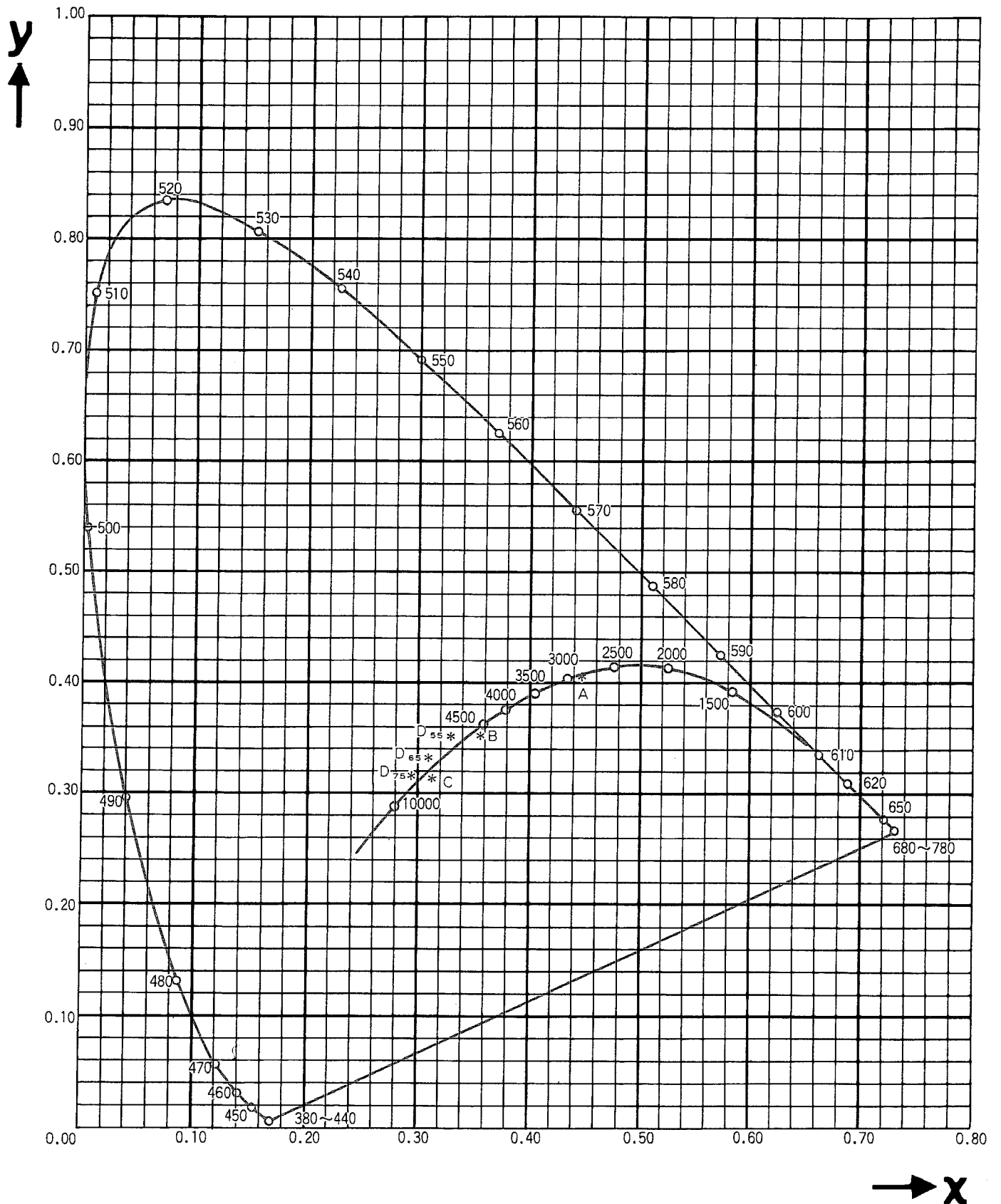

Portion of the CIE 1931 (x,y) – Chromaticity Diagram
showing the Planckian locus and a set of ISO temperature lines

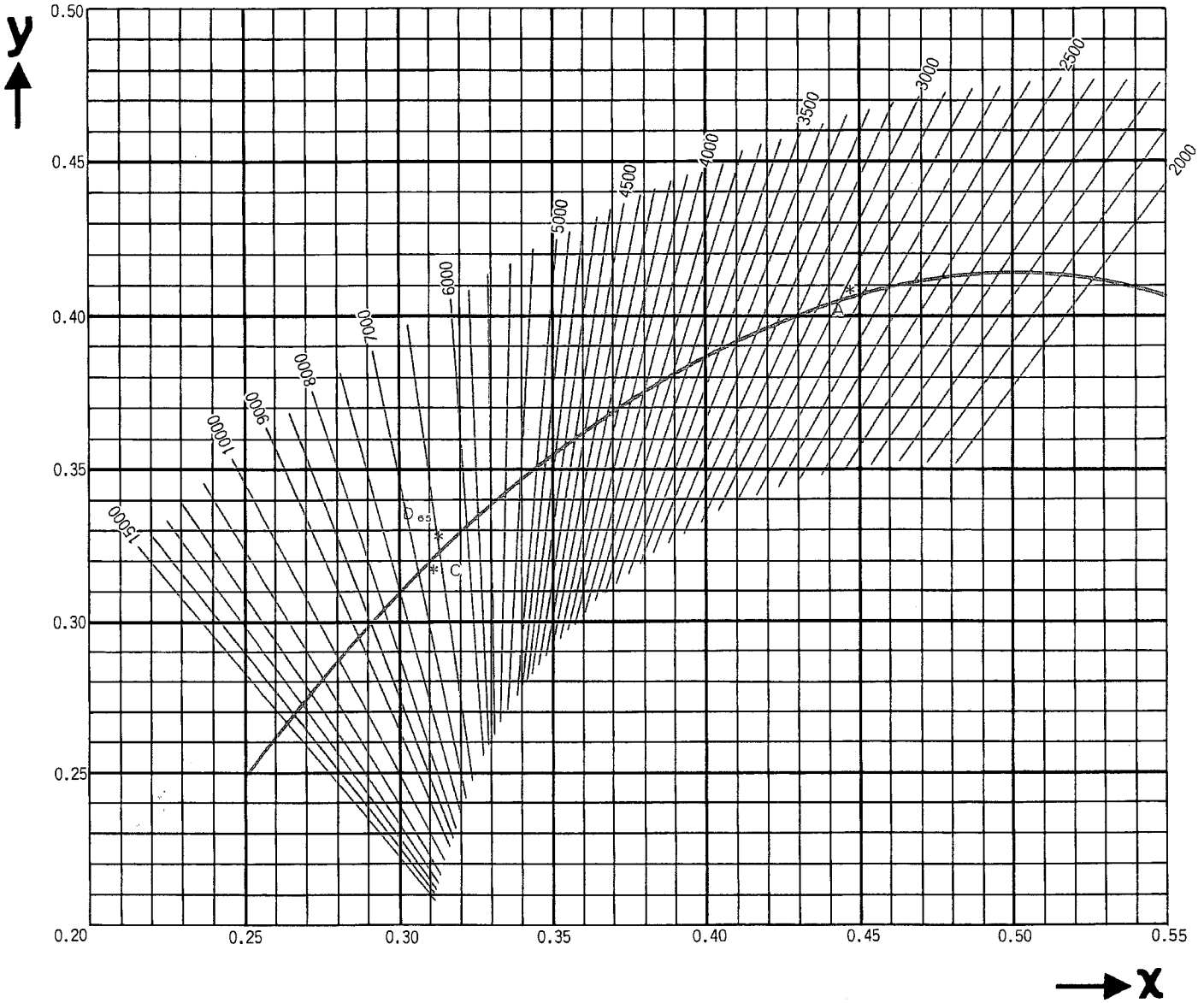

CIE 1976 (u',v') – Chromaticity Diagram

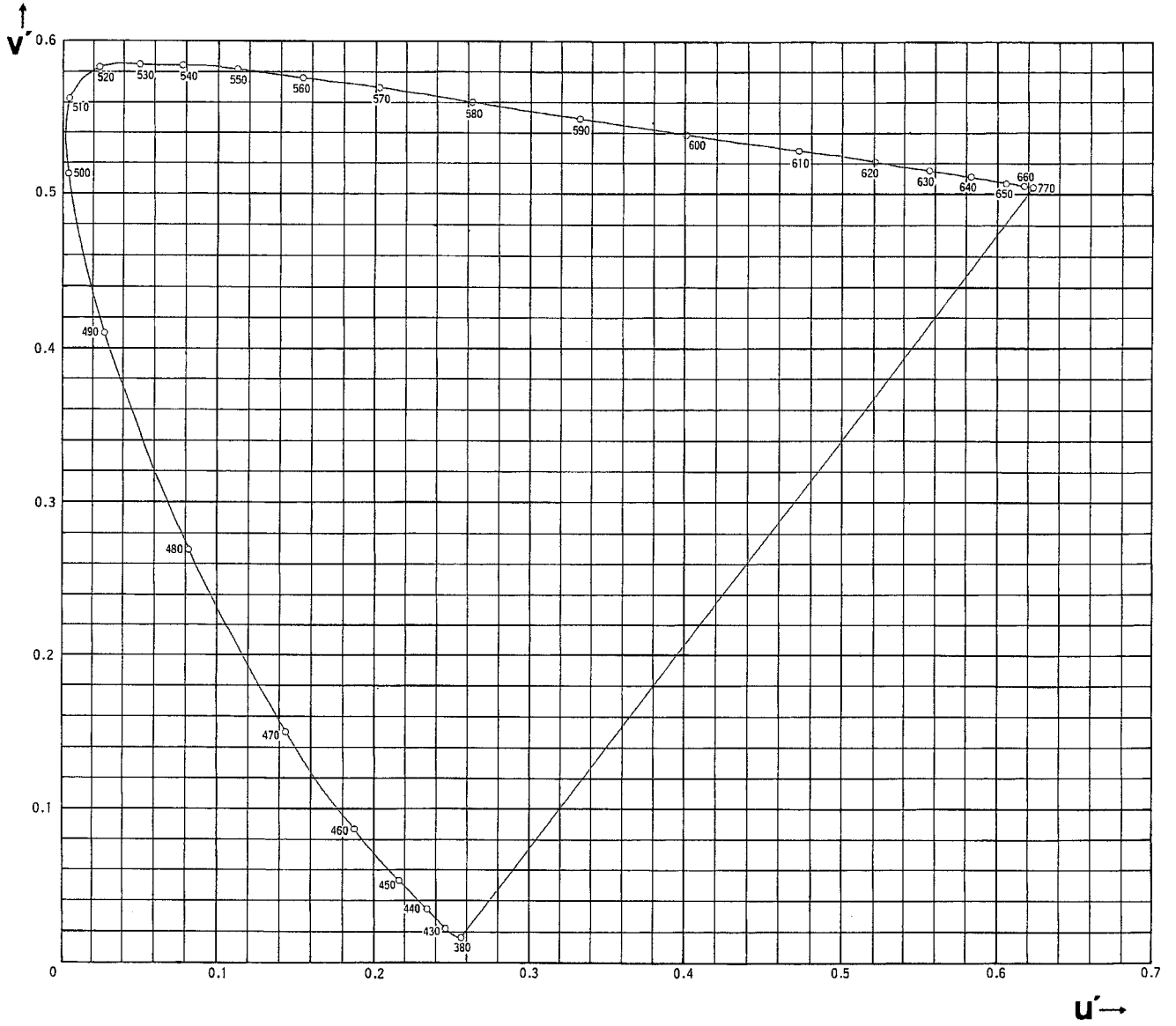

MEASURING CHROMATICITY

The chromaticity-measuring modes include Y_{xy} (CIE 1931) for measuring illuminance and chromaticity coordinates on the CIE Chromaticity Diagram, and $Y_{u'v'}$ (CIE 1976) for measuring illuminance and color difference as perceived by humans.

To measure:

1. Set the calibration-selector switch to "PRESET" (for normal use, calibrated to Minolta's standard Illuminant A) or "VARI." (if the meter has been calibrated to user's standard; see page 10).
2. Set the deviation-setting switch to "NORM."
3. While pressing \boxed{F} , press \boxed{MODE} and set the measuring mode to either Y_{xy} or $Y_{u'v'}$.

NOTE

- Chromaticity may be measured in either mode, then changed after measurement to the other mode.

4. Point the meter's light receptor towards the light source and press the measuring button. The measured value will appear on the display in approximately one second.

NOTE

- When the display reads "CAL", the meter is in the process of calculating and measurements are not possible at this time even if the measuring button is pressed.

5. To convert the measured value from one mode to the other, hold down \boxed{F} and press \boxed{MODE} . The measured value will be automatically translated from Y_{xy} to $Y_{u'v'}$ or vice versa.

MEASURING COLOR DEVIATION

Color-deviation measuring modes for determining the deviation between a reference color and a measured value include: $\pm\Delta(Y_{xy})$, $\pm\Delta(Y_{u'v'})$, and $\Delta u'v'$.

To measure color deviation, a reference color must first be inputted to memory. The reference color can either be measured directly then inputted to memory, or a reference color with a known value can be manually inputted by keys.

Spectral Response

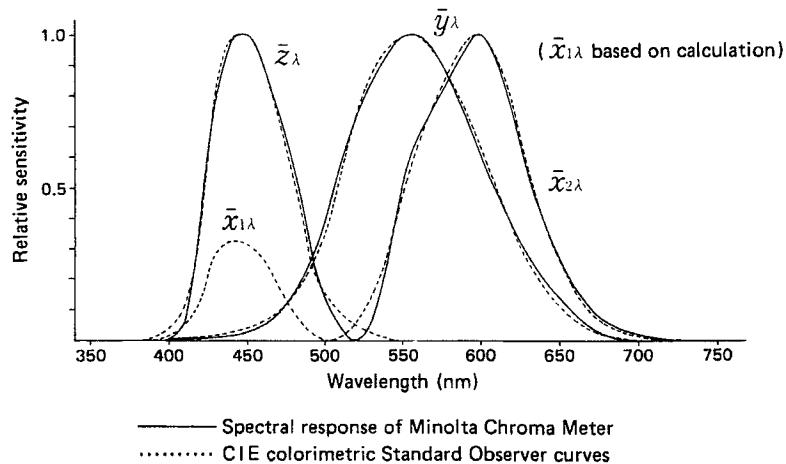

System Diagram

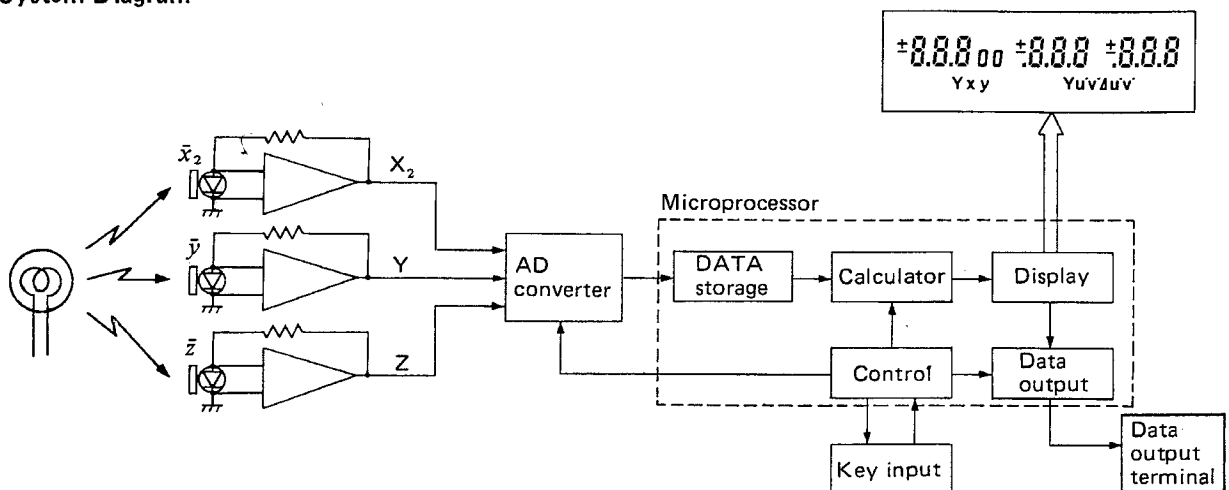

Measuring and memorizing reference color

A. Measuring

1. Set the deviation-setting switch to "NORM."
2. Hold down **[F]** and press **[MODE]** until the Yxy mode appears on the display.
3. Position the meter's light receptor under the reference light source and press the measuring button. The measured value will appear on the display.

B. Memorizing

1. To input the measured value into memory, press and hold **[F]** then slide the deviation-setting switch to "Δ". The display will change to "CAL" for a moment as the Yxy value is memorized, then it will revert to the measured value.

NOTE

- This memorized reference value will remain in memory until changed by the user or until the battery is changed.

2. Press **[MODE]**. To indicate that the data has been correctly memorized, the display will then read:

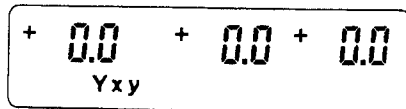

The meter is now ready to measure deviation.

NOTE

- The reference value, which is inputted into memory, shall be the average of the several measurements.

Setting and memorizing reference data

When the Yxy data for your reference light source is known, data can be manually set and memorized as your reference light source in the following way:

A. Setting data

Reference color data is set by adjusting previously memorized reference data ("Regular method"). When color deviation measurement is being performed for first time and there is no reference data in memory, or when previously memorized data is very different from data to be memorized, data can be set more quickly by measuring a color similar to the reference color, inputting it to memory, then adjusting it to the desired value ("Quick method").

Regular method

1. Set the deviation-setting switch to "Δ".
2. Press **[DATA]**. The display will read all 0's if there is no reference data memorized; if memorized, reference data will appear. "±" will appear before each figure to indicate that reference data is on display.
3. Press **[DATA]** again. Only the value for "Y" will appear in the display. Hold down **[F]**, then press **[↑]** or **[↓]** to set the desired reference value for "Y".
4. Repeat step 3 for "x" and "y".
5. Press **[DATA]** once more. The three values set for "Yxy" will appear in the display.

NOTE

- The data-setting cycle will start over if **[DATA]** is pressed again.

Quick method

1. Measure a light source similar in value to the reference light source. Follow steps 1 – 3 of "Measuring" procedure under "Measuring and memorizing reference color", left column.
2. Memorize this value by holding **[F]** and sliding the deviation-setting switch to "Δ".
3. Press **[DATA]**. The display will show the data memorized for the light source measured above.
4. Follow steps 3 – 5 in preceding "Regular method" section to set the desired reference data.

NOTE

- Steps 3 and 4 above are necessary even when measured value is equal to the data to be memorized.

B. Memorizing

1. After setting all three values for "Yxy", slide the deviation-setting switch to "NORM." Press and hold **[F]**, then slide the deviation-setting switch back to "Δ". The display will read "CAL" for a moment as the Yxy value is memorized, then it will revert to the previously displayed number.

NOTE

- This memorized reference value will remain in memory until changed by the user or until the battery is changed.

Measuring color deviation

1. Set the deviation-setting switch to "Δ".
2. Select color-deviation measuring mode by holding down **[F]** and pressing **[MODE]** until the desired mode appears in the display window.

NOTE

- The measured value can be converted from one mode to another after measurement by pressing **[F]** and **[MODE]**.
3. Point the meter's light receptor towards the light source to be measured and press the measuring button. The measured value will appear on the display in approximately one second.

NOTE

- Actual measurement takes approx. 0.25 second.
- The values that appear on display for $\pm\Delta x$, $\pm\Delta y$, $\pm\Delta u'$, $\pm\Delta v'$, and $\Delta u'v'$ are expressed as 1,000 times their actual measured value (see "Measuring modes", page 4).
- In measuring modes $\pm\Delta(Yxy)$, $\pm\Delta(Yuv')$, and $\Delta u'v'$; $\pm\Delta x$, $\pm\Delta y$, $\pm\Delta u'$, $\pm\Delta v'$, and $\Delta u'v'$ are calculated to the ten thousandths' place (10^{-4}).
- When the measured value is out of display range, "E9" appears in the display.
- After measuring color deviation, the measurement on display can be converted to illuminance and chromaticity units by sliding the deviation-setting switch to "NORM." and pressing **[MODE]**.

Reference color data recall

To recall the reference color data from memory:

1. Set the deviation-setting switch to "Δ".
2. Press **DATA**. The memorized reference color data will appear in the display.

NOTE

- Moving the deviation-setting switch or calibration-selector switch after pressing **DATA** will not change the display. In this case, press **MODE**, then press **DATA** again to recall data.

CALIBRATING METER TO USER'S STANDARD

The Minolta Chroma Meter CL-100 is calibrated to Minolta's standard Illuminant A. When the calibration-selector switch is in the "PRESET" position, the meter's readings are based on this Minolta standard. However, there may be times when you wish to calibrate the meter to your own standard or to precisely unify several meters and eliminate subtle variations in their spectral responses. For this purpose, the meter provides a "VARI." setting on the calibration-selector switch.

Calibrating meter

Calibrate the meter to your own standard light source in the following way:

A. Measuring your standard light source

1. Set the calibration-selector switch to "VARI" and the deviation-setting switch to "NORM."
2. While pressing **F**, press **MODE** and set the measuring mode to Yxy.
3. Point the meter's light receptor toward your standard light source and press the measuring button. The measured value will appear on display.

B. Setting calibration data

Calibration data can be set by adjusting previously memorized user's calibration data ("Regular method"), or when user calibration is being performed for the first time and there is no user's calibration data in memory, by memorizing the measured value, then adjusting it to the desired value ("Quick method").

CAUTION

- "Quick method" inputs a value into deviation memory and thus erases memory of color reference data for color-deviation measuring mode if previously set.

Regular method

1. With the calibration-selector switch at "VARI." and the deviation-setting switch at "NORM.", press **DATA**. The display will read all 0's if there is no calibration data in memory; otherwise, calibration data will appear. "±" will appear before each figure to indicate that calibration data is on display.
2. Press **DATA** again. Only the value for "Y" will appear in the display. Hold down **F**, then press **↑** or **↓** to set the calibration standard's value for "Y".

3. Repeat step 2 for "x" and "y".
4. Press **DATA** once more. The three values set for "Yxy" will appear in the display.

NOTE

- The data-setting cycle will start over if **DATA** is pressed again.

Quick method

1. Set the calibration-selector switch to "VARI."
2. Measure the selected standard (follow steps 2 – 4 in MEASURING CHROMATICITY procedure, page 8).
3. Memorize this value by holding **F** and sliding the deviation-setting switch to "Δ".
4. Press **DATA**. The display will show the data memorized for the measured light source.
5. Slide the deviation-setting switch to "NORM."
6. Follow steps 2 – 4 preceding "Regular method" section to set the desired calibration standard data.

NOTE

- Steps 2 and 3 are necessary even when the measured value is equal to the data to be memorized.

C. Memorizing calibration data

1. After setting all three values for "Yxy", slide the calibration-selector switch from "VARI." to "PRESET", press and hold **F**, then slide the switch back to "VARI." The display will read "CAL" for a moment as the Yxy value is being memorized, then will revert to the calibration value.

NOTE

- This memorized calibration data will remain in memory until changed by the user or until the battery is changed.
- Calibration cannot be performed if $y < (1 - 6.98x)$ in the data set. In this case, the display will read "E" when the memory function is performed.

E
Yxy

Unifying meters

To unify several meters, calibrate all meters to the same standard light source. Select one meter as the master, measure the standard with the master meter, and input this calibration data to all meters following procedures B and C in preceding "Calibrating meter" section.

Calibration data recall

To recall calibration data from memory:

1. Set the calibration-selector switch to "VARI." and the deviation-setting switch to "NORM."
2. Press **DATA**. The memorized calibration data for your standard will appear in the display window.

NOTE

- Moving the deviation-setting switch or calibration-selector switch after pressing **DATA** will not change the display. In this case, press **MODE**, then press **DATA** again to recall data.

DATA OUTPUT

The Chroma Meter CL-100 can input measured data to a separate computer through its data-output terminal using the data-output cord included with the meter. The data-output circuit is an open-collector type. The connecting pins of the data-output terminal are wired as shown in the diagram below:

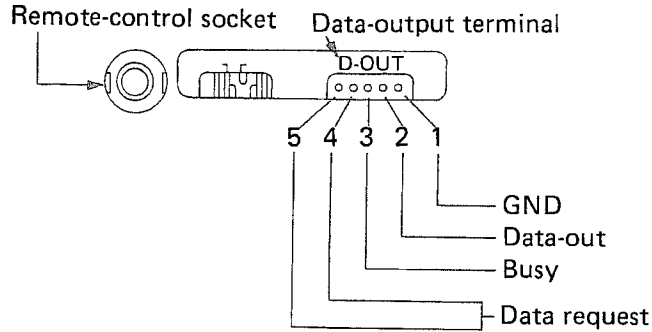

Data-output circuit

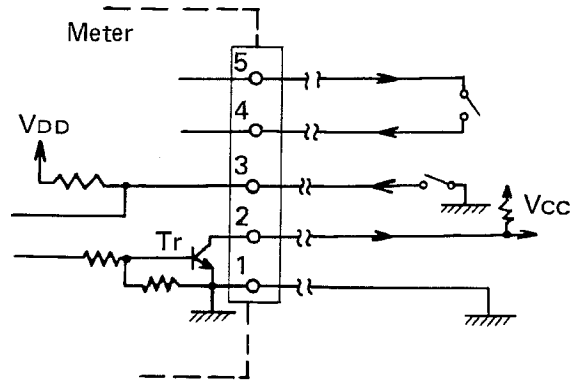

Remote-control circuit

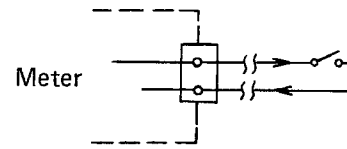

For remote control, use the remote-control plug.

Tr Maximum output (at 25°C)

| | |
|----------------------------|------------------------|
| Collector base voltage: | V _{CBO} : 50v |
| Collector emitter voltage: | V _{CEO} : 40v |
| Emitter base voltage: | V _{EBO} : 5v |
| Collector current: | I _c : 100mA |
| Collector loss: | PC: 300mW |

The starting signal for data output is triggered by pressing **D-OUT** or by computer data request through the data-output terminal (by connecting terminals 4 and 5).

Output for each datum includes 18 bits: 8 bits for data signal (see tables on page 12), 10 bits for spare signal (Hi: 5 bits, Lo: 4 bits, Hi: 1 bit). Data is output 15 times* for each full display.

* 14 and 15 are apply only to the Yxy measuring mode.

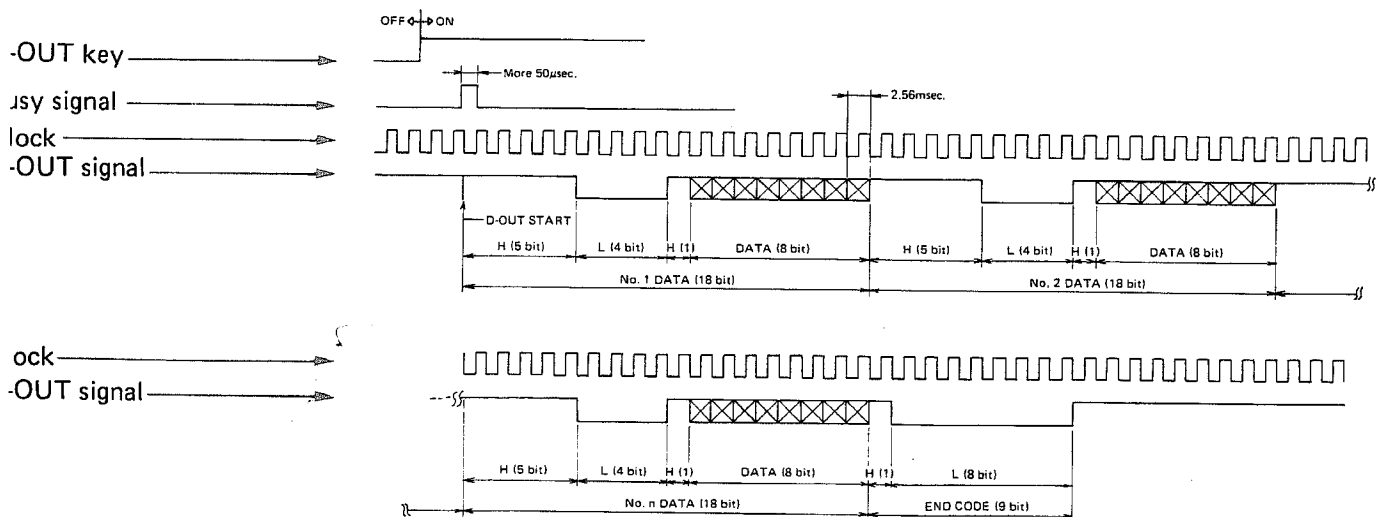

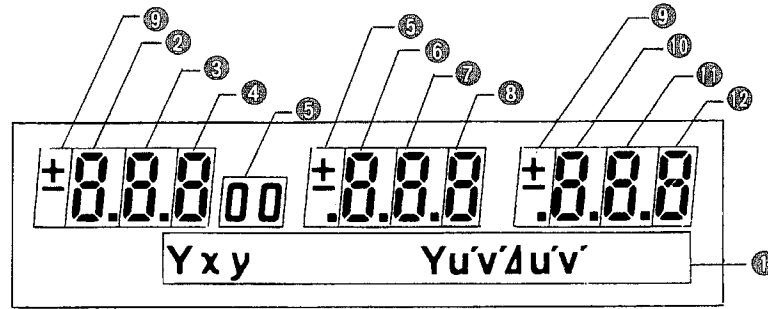

Data Output Table

| Sequence of data output | | (MSB) | Data output (8 bits) | | | | | | | Display | | | |
|-------------------------|-------------------------------------|-------|----------------------|---|---|---|---|------------------|---|-----------------------|--|--|--|
| 1 | MODE | 1 | 1 | 1 | 1 | 1 | 1 | 1 | 0 | Yxy | | | |
| | | 1 | 0 | 1 | 1 | 1 | 1 | 1 | 1 | Yu'v' | | | |
| | | 1 | 1 | 1 | 1 | 1 | 0 | 1 | 1 | Δu'v' | | | |
| 2 | Y (first place) | | | | | | | | | see Code Number Table | | | |
| 3 | Y (second place) | | | | | | | | | " " " " | | | |
| 4 | Y (third place) | | | | | | | | | " " " " | | | |
| 5 | Y (place holders) (lower 4 bits) | - | - | - | - | 1 | 1 | 1 | 1 | do not come on | | | |
| | | - | - | - | - | 1 | 1 | 0 | 1 | "0" (for Y x 10) on | | | |
| | | - | - | - | - | 1 | 0 | 0 | 1 | "00" (for Y x 100) on | | | |
| | sign for x (upper 4 bits) | - | - | 1 | 1 | - | - | - | - | blank | | | |
| | | - | - | 0 | 1 | - | - | - | - | - | | | |
| | | - | - | 1 | 0 | - | - | - | - | + | | | |
| | | - | - | 0 | 0 | - | - | - | - | ± | | | |
| | | - | 1 | - | - | - | - | - | - | no decimal point | | | |
| - | 0 | - | - | - | - | - | - | decimal point | | | | | |
| 6 | x (first place) | | | | | | | | | see Code Number Table | | | |
| 7 | x (second place) | | | | | | | | | " " " " | | | |
| 8 | x (third place) | | | | | | | | | " " " " | | | |
| 9 | sign for Y (lower 4 bits) | - | - | - | - | - | - | 1 | 1 | blank | | | |
| | | - | - | - | - | - | - | 0 | 1 | - | | | |
| | | - | - | - | - | - | - | 1 | 0 | + | | | |
| | | - | - | - | - | - | - | 0 | 0 | ± | | | |
| | sign for y (upper 4 bits) | - | - | 1 | 1 | - | - | - | - | blank | | | |
| | | - | - | 0 | 1 | - | - | - | - | - | | | |
| | | - | - | 1 | 0 | - | - | - | - | + | | | |
| | | - | - | 0 | 0 | - | - | - | - | ± | | | |
| - | 1 | - | - | - | - | - | - | no decimal point | | | | | |
| - | 0 | - | - | - | - | - | - | decimal point | | | | | |
| 10 | y (first place) | | | | | | | | | see Code Number Table | | | |
| 11 | y (second place) | | | | | | | | | " " " " | | | |
| 12 | y (third place) | | | | | | | | | " " " " | | | |
| 13* | Y (fourth place) | | | | | | | | | " " " " | | | |
| 14** | x (fourth place) | | | | | | | | | " " " " | | | |
| 15** | y (fourth place) | | | | | | | | | " " " " | | | |

* output to computer, but does not appear on display; value not significant

** output to computer, but does not appear on display; value is significant

Code Number Table

| (MSB) | Base 2 code | | | | | | | Base 16 code | Display |
|-------|-------------|---|---|---|---|---|---|--------------|---------|
| 1 | 0 | 0 | 0 | 0 | 0 | 1 | 0 | 82 | 0 |
| 0 | 0 | 0 | 0 | 0 | 0 | 1 | 0 | 02 | 0. |
| 1 | 0 | 0 | 1 | 1 | 1 | 1 | 1 | 9F | 1 |
| 0 | 0 | 0 | 1 | 1 | 1 | 1 | 1 | 1F | 1. |
| 1 | 1 | 0 | 0 | 0 | 0 | 0 | 1 | C1 | 2 |
| 0 | 1 | 0 | 0 | 0 | 0 | 0 | 1 | 41 | 2. |
| 1 | 0 | 0 | 0 | 0 | 1 | 0 | 1 | 85 | 3 |
| 0 | 0 | 0 | 0 | 0 | 1 | 0 | 1 | 05 | 3. |
| 1 | 0 | 0 | 1 | 1 | 1 | 0 | 0 | 9C | 4 |
| 0 | 0 | 0 | 1 | 1 | 1 | 0 | 0 | 1C | 4. |
| 1 | 0 | 1 | 0 | 0 | 1 | 0 | 0 | A4 | 5 |
| 0 | 0 | 1 | 0 | 0 | 1 | 0 | 0 | 24 | 5. |

| (MSB) | Base 2 code | | | | | | | Base 16 code | Display |
|-------|-------------|---|---|---|---|---|---|--------------|---------|
| 1 | 0 | 1 | 0 | 0 | 0 | 0 | 0 | A0 | 6 |
| 0 | 0 | 1 | 0 | 0 | 0 | 0 | 0 | 20 | 6. |
| 1 | 0 | 0 | 0 | 1 | 1 | 1 | 0 | 8E | 7 |
| 0 | 0 | 0 | 0 | 1 | 1 | 1 | 0 | 0E | 7. |
| 1 | 0 | 0 | 0 | 0 | 0 | 0 | 0 | 80 | 8 |
| 0 | 0 | 0 | 0 | 0 | 0 | 0 | 0 | 00 | 8. |
| 1 | 0 | 0 | 0 | 0 | 1 | 0 | 0 | 84 | 9 |
| 0 | 0 | 0 | 0 | 0 | 1 | 0 | 0 | 04 | 9. |
| 1 | 1 | 1 | 0 | 0 | 0 | 0 | 0 | E0 | E |
| 0 | 1 | 1 | 0 | 0 | 0 | 0 | 0 | 60 | E. |
| 1 | 0 | 1 | 1 | 0 | 0 | 0 | 0 | B0 | b |
| 1 | 1 | 1 | 1 | 1 | 1 | 1 | 1 | FF | blank |

Example data-output program

The following is an example program for sending D-OUT signal into a microcomputer. This example program is for the Z-80 with the following data conditions:

Clock frequency 2MHz
 Interface address 64H
 Data storage RAM address CE01H – CE11H

```

1          ;
2          ;*** DOUT SUBROUTINE***
3          ;
4 CE01     MODE     EQU     0CE01H
5 CE02     YY1      EQU     0CE02H ;Y (first place)
6 CE03     YY2      EQU     0CE03H ;Y (second place)
7 CE04     YY3      EQU     0CE04H ;Y (third place)
8 CE05     YY4      EQU     0CE05H ;Y (fourth place)
9 CE06     RANGE    EQU     0CE06H ;range for Y
10 CE07     X1       EQU     0CE07H ;x (first place)
11 CE08     X2       EQU     0CE08H ;x (second place)
12 CE09     X3       EQU     0CE09H ;x (third place)
13 CE0A     X4       EQU     0CE0AH ;x (fourth place)
14 CE0B     YY0      EQU     0CE0BH ;sign for Y
15 CE0C     Y1       EQU     0CE0CH ;y (first place)
16 CE0D     Y2       EQU     0CE0DH ;y (second place)
17 CE0E     Y3       EQU     0CE0EH ;y (third place)
18 CE0F     Y4       EQU     0CE0FH ;y (fourth place)
19 CE10     X0       EQU     0CE10H ;sign for x
20 CE11     Y0       EQU     0CE11H ;sign for y
1 0044     P10      EQU     0064H ;interface address
2 0000' 21 01CE  START: LD HL,0CE01H
3 0003' DB 64      MMM1: IN A,(P10)
4 0005' CB 47      BIT 0,A ;LSB check
5 0007' 20 FA      JR NZ,MMM1
6 0009' 16 7D      LD D,7DH
7 000B' CD AA00    CALL TIMER ;wait 1.2 msec.
8 000E' DB 64      IN A,(P10)
9 0010' CB 47      BIT 0,A ;LSB check
10 0012' 20 EF     JR NZ,MMM1
11 0014' 06 03     LD B,03H
12 0016' 16 FC     MMM2: LD D,0FCH
13 0018' CD AA00    CALL TIMER ;wait 2.5 msec.
14 001B' DB 64      IN A,(P10)
15 001D' CB 47     BIT 0,A ;LSB check
16 001F' 20 E2     JR NZ,MMM1
17 0021' 05        DEC B
18 0022' 20 F2     JR NZ,MMM2
19          ;
20          ;DATA INPUT START
21 0024' 16 FC     LD D,0FCH
22 0026' CD AA00   CALL TIMER ;wait 2.5 msec.
23 0029' 01 0080   LD BC,0800H
24 002C' 16 FC     MMM3: LD D,0FCH
25 002E' CD AA00   CALL TIMER ;wait 2.5 msec.
26 0031' DB 64     IN A,(P10)
27 0033' E6 01     AND 01H
28 0035' B1        OR C
29 0036' CB 17     RL A
30 0038' 4F        LD C,A
31 0039' 05        DEC B
32 003A' 20 F0     JR NZ,MMM3
33 003C' CB 1F     RR A
34 003E' 77        LD (HL),A
35 003F' 23        INC HL
36 0040' 16 FC     LD D,0FCH
37 0042' CD AA00   CALL TIMER ;wait 2.5 msec.
38 0045' 04 07     LD B,07H
39 0047' 16 FC     MMM4: LD D,0FCH
40 0049' CD AA00   CALL TIMER ;end code 8 bit check
41 004C' DB 64     IN A,(P10)
42          ;
43          ;
44          ;
45          ;
46          ;DATA INPUT END
47          LD A,(MODE)
48          CP 0FEH
49          JR Z,LOOP1
50          CP 7EH
51          JR Z,MMM5
52          CP 0F6H
53          JR NZ,MMM7
54          RL A
55          LD A,(Y2)
56          LD C,17
57          JR NC,MMM6
58          INC D
59          LD A,(X2)
60          RL A
61          JR C,MMM8
62          LD L,0DH
63          LD E,0FFH
64          LD (HL),E
65          ;BLANK (fourth place)
66          ;
67          ;
68          ;
69          ;
70          ;Y RANGE *100= 9H
71          ; *10 = DH
72          ; *1 = EH
73          ; *0.1= FH
74          ;
75          ;
76          ;
77          ;
78          ;
79          ;
80          ;
81          ;
82          ;
83          ;
84          ;
85          ;
86          ;
87          ;
88          ;
89          ;
90          ;
91          ;
92          ;
93          ;
94          ;
95          ;
96          ;
97          ;
98          ;
99          ;
100         ;
101         ;
102         ;
103         ;
104         ;
105         ;
106         ;
107         ;
108         ;
109         ;
110         ;
111         ;
112         ;
113         ;
114         ;
115         ;
116         ;
117         ;
118         ;
119         ;
120         ;
121         ;
122         ;
123         ;
124         ;
125         ;
126         ;
127         ;
128         ;
129         ;
130         ;
131         ;
132         ;
133         ;
134         ;
135         ;
136         ;
137         ;
138         ;
139         ;
140         ;
141         ;
142         ;
143         ;
144         ;
145         ;
146         ;
147         ;
148         ;
149         ;
150         ;
151         ;
152         ;
153         ;
154         ;
155         ;
156         ;
157         ;
158         ;
159         ;
160         ;
161         ;
162         ;
163         ;
164         ;
165         ;
166         ;
167         ;
168         ;
169         ;
170         ;
171         ;
172         ;
173         ;
174         ;
175         ;
176         ;
177         ;
178         ;
179         ;
180         ;
181         ;
182         ;
183         ;
184         ;
185         ;
186         ;
187         ;
188         ;
189         ;
190         ;
191         ;
192         ;
193         ;
194         ;
195         ;
196         ;
197         ;
198         ;
199         ;
200         ;
201         ;
202         ;
203         ;
204         ;
205         ;
206         ;
207         ;
208         ;
209         ;
210         ;
211         ;
212         ;
213         ;
214         ;
215         ;
216         ;
217         ;
218         ;
219         ;
220         ;
221         ;
222         ;
223         ;
224         ;
225         ;
226         ;
227         ;
228         ;
229         ;
230         ;
231         ;
232         ;
233         ;
234         ;
235         ;
236         ;
237         ;
238         ;
239         ;
240         ;
241         ;
242         ;
243         ;
244         ;
245         ;
246         ;
247         ;
248         ;
249         ;
250         ;
251         ;
252         ;
253         ;
254         ;
255         ;
256         ;
257         ;
258         ;
259         ;
260         ;
261         ;
262         ;
263         ;
264         ;
265         ;
266         ;
267         ;
268         ;
269         ;
270         ;
271         ;
272         ;
273         ;
274         ;
275         ;
276         ;
277         ;
278         ;
279         ;
280         ;
281         ;
282         ;
283         ;
284         ;
285         ;
286         ;
287         ;
288         ;
289         ;
290         ;
291         ;
292         ;
293         ;
294         ;
295         ;
296         ;
297         ;
298         ;
299         ;
300         ;
301         ;
302         ;
303         ;
304         ;
305         ;
306         ;
307         ;
308         ;
309         ;
310         ;
311         ;
312         ;
313         ;
314         ;
315         ;
316         ;
317         ;
318         ;
319         ;
320         ;
321         ;
322         ;
323         ;
324         ;
325         ;
326         ;
327         ;
328         ;
329         ;
330         ;
331         ;
332         ;
333         ;
334         ;
335         ;
336         ;
337         ;
338         ;
339         ;
340         ;
341         ;
342         ;
343         ;
344         ;
345         ;
346         ;
347         ;
348         ;
349         ;
350         ;
351         ;
352         ;
353         ;
354         ;
355         ;
356         ;
357         ;
358         ;
359         ;
360         ;
361         ;
362         ;
363         ;
364         ;
365         ;
366         ;
367         ;
368         ;
369         ;
370         ;
371         ;
372         ;
373         ;
374         ;
375         ;
376         ;
377         ;
378         ;
379         ;
380         ;
381         ;
382         ;
383         ;
384         ;
385         ;
386         ;
387         ;
388         ;
389         ;
390         ;
391         ;
392         ;
393         ;
394         ;
395         ;
396         ;
397         ;
398         ;
399         ;
400         ;
401         ;
402         ;
403         ;
404         ;
405         ;
406         ;
407         ;
408         ;
409         ;
410         ;
411         ;
412         ;
413         ;
414         ;
415         ;
416         ;
417         ;
418         ;
419         ;
420         ;
421         ;
422         ;
423         ;
424         ;
425         ;
426         ;
427         ;
428         ;
429         ;
430         ;
431         ;
432         ;
433         ;
434         ;
435         ;
436         ;
437         ;
438         ;
439         ;
440         ;
441         ;
442         ;
443         ;
444         ;
445         ;
446         ;
447         ;
448         ;
449         ;
450         ;
451         ;
452         ;
453         ;
454         ;
455         ;
456         ;
457         ;
458         ;
459         ;
460         ;
461         ;
462         ;
463         ;
464         ;
465         ;
466         ;
467         ;
468         ;
469         ;
470         ;
471         ;
472         ;
473         ;
474         ;
475         ;
476         ;
477         ;
478         ;
479         ;
480         ;
481         ;
482         ;
483         ;
484         ;
485         ;
486         ;
487         ;
488         ;
489         ;
490         ;
491         ;
492         ;
493         ;
494         ;
495         ;
496         ;
497         ;
498         ;
499         ;
500         ;
501         ;
502         ;
503         ;
504         ;
505         ;
506         ;
507         ;
508         ;
509         ;
510         ;
511         ;
512         ;
513         ;
514         ;
515         ;
516         ;
517         ;
518         ;
519         ;
520         ;
521         ;
522         ;
523         ;
524         ;
525         ;
526         ;
527         ;
528         ;
529         ;
530         ;
531         ;
532         ;
533         ;
534         ;
535         ;
536         ;
537         ;
538         ;
539         ;
540         ;
541         ;
542         ;
543         ;
544         ;
545         ;
546         ;
547         ;
548         ;
549         ;
550         ;
551         ;
552         ;
553         ;
554         ;
555         ;
556         ;
557         ;
558         ;
559         ;
560         ;
561         ;
562         ;
563         ;
564         ;
565         ;
566         ;
567         ;
568         ;
569         ;
570         ;
571         ;
572         ;
573         ;
574         ;
575         ;
576         ;
577         ;
578         ;
579         ;
580         ;
581         ;
582         ;
583         ;
584         ;
585         ;
586         ;
587         ;
588         ;
589         ;
590         ;
591         ;
592         ;
593         ;
594         ;
595         ;
596         ;
597         ;
598         ;
599         ;
600         ;
601         ;
602         ;
603         ;
604         ;
605         ;
606         ;
607         ;
608         ;
609         ;
610         ;
611         ;
612         ;
613         ;
614         ;
615         ;
616         ;
617         ;
618         ;
619         ;
620         ;
621         ;
622         ;
623         ;
624         ;
625         ;
626         ;
627         ;
628         ;
629         ;
630         ;
631         ;
632         ;
633         ;
634         ;
635         ;
636         ;
637         ;
638         ;
639         ;
640         ;
641         ;
642         ;
643         ;
644         ;
645         ;
646         ;
647         ;
648         ;
649         ;
650         ;
651         ;
652         ;
653         ;
654         ;
655         ;
656         ;
657         ;
658         ;
659         ;
660         ;
661         ;
662         ;
663         ;
664         ;
665         ;
666         ;
667         ;
668         ;
669         ;
670         ;
671         ;
672         ;
673         ;
674         ;
675         ;
676         ;
677         ;
678         ;
679         ;
680         ;
681         ;
682         ;
683         ;
684         ;
685         ;
686         ;
687         ;
688         ;
689         ;
690         ;
691         ;
692         ;
693         ;
694         ;
695         ;
696         ;
697         ;
698         ;
699         ;
700         ;
701         ;
702         ;
703         ;
704         ;
705         ;
706         ;
707         ;
708         ;
709         ;
710         ;
711         ;
712         ;
713         ;
714         ;
715         ;
716         ;
717         ;
718         ;
719         ;
720         ;
721         ;
722         ;
723         ;
724         ;
725         ;
726         ;
727         ;
728         ;
729         ;
730         ;
731         ;
732         ;
733         ;
734         ;
735         ;
736         ;
737         ;
738         ;
739         ;
740         ;
741         ;
742         ;
743         ;
744         ;
745         ;
746         ;
747         ;
748         ;
749         ;
750         ;
751         ;
752         ;
753         ;
754         ;
755         ;
756         ;
757         ;
758         ;
759         ;
760         ;
761         ;
762         ;
763         ;
764         ;
765         ;
766         ;
767         ;
768         ;
769         ;
770         ;
771         ;
772         ;
773         ;
774         ;
775         ;
776         ;
777         ;
778         ;
779         ;
780         ;
781         ;
782         ;
783         ;
784         ;
785         ;
786         ;
787         ;
788         ;
789         ;
790         ;
791         ;
792         ;
793         ;
794         ;
795         ;
796         ;
797         ;
798         ;
799         ;
800         ;
801         ;
802         ;
803         ;
804         ;
805         ;
806         ;
807         ;
808         ;
809         ;
810         ;
811         ;
812         ;
813         ;
814         ;
815         ;
816         ;
817         ;
818         ;
819         ;
820         ;
821         ;
822         ;
823         ;
824         ;
825         ;
826         ;
827         ;
828         ;
829         ;
830         ;
831         ;
832         ;
833         ;
834         ;
835         ;
836         ;
837         ;
838         ;
839         ;
840         ;
841         ;
842         ;
843         ;
844         ;
845         ;
846         ;
847         ;
848         ;
849         ;
850         ;
851         ;
852         ;
853         ;
854         ;
855         ;
856         ;
857         ;
858         ;
859         ;
860         ;
861         ;
862         ;
863         ;
864         ;
865         ;
866         ;
867         ;
868         ;
869         ;
870         ;
871         ;
872         ;
873         ;
874         ;
875         ;
876         ;
877         ;
878         ;
879         ;
880         ;
881         ;
882         ;
883         ;
884         ;
885         ;
886         ;
887         ;
888         ;
889         ;
890         ;
891         ;
892         ;
893         ;
894         ;
895         ;
896         ;
897         ;
898         ;
899         ;
900         ;
901         ;
902         ;
903         ;
904         ;
905         ;
906         ;
907         ;
908         ;
909         ;
910         ;
911         ;
912         ;
913         ;
914         ;
915         ;
916         ;
917         ;
918         ;
919         ;
920         ;
921         ;
922         ;
923         ;
924         ;
925         ;
926         ;
927         ;
928         ;
929         ;
930         ;
931         ;
932         ;
933         ;
934         ;
935         ;
936         ;
937         ;
938         ;
939         ;
940         ;
941         ;
942         ;
943         ;
944         ;
945         ;
946         ;
947         ;
948         ;
949         ;
950         ;
951         ;
952         ;
953         ;
954         ;
955         ;
956         ;
957         ;
958         ;
959         ;
960         ;
961         ;
962         ;
963         ;
964         ;
965         ;
966         ;
967         ;
968         ;
969         ;
970         ;
971         ;
972         ;
973         ;
974         ;
975         ;
976         ;
977         ;
978         ;
979         ;
980         ;
981         ;
982         ;
983         ;
984         ;
985         ;
986         ;
987         ;
988         ;
989         ;
990         ;
991         ;
992         ;
993         ;
994         ;
995         ;
996         ;
997         ;
998         ;
999         ;
1000        ;

```

CRT-READING HOOD

For measuring chromaticity and color-deviation of cathode-ray tubes, a CRT-reading hood is provided with the meter. It attaches over the light receptor to provide a constant measuring area and constant distance from the CRT. Be sure to hold the meter with the hood flush against the CRT when taking a measurement.

For CRT measurement, units can be converted from lux to cd/m^2 by following the procedure for calibrating to the user's standard. To convert units, measure the CRT with a luminance meter, then input that value as the calibration standard.

NOTE

- When attaching the hood, be sure to align guides properly.

DETACHABLE RECEPTOR HEAD

The Chroma Meter CL-100's receptor head can be detached from the meter body for use with the turn adapter included with the meter or with optional accessories, such as Adapter Cords MA-1 (2m) or

MA-2 (1m). All operations remain the same as when receptor head and meter body are directly attached.

TURN ADAPTER

The turn adapter can be used to reverse the direction of the receptor head. This allows the user to hold the meter facing its display panel while measuring a light source 180 degrees behind the meter.

Attaching the adapter

1. Detach the meter's regular receptor head by pressing the receptor-head release button and pulling the head straight out from the meter body. Be careful not to touch or damage the pins.
2. Remove the protective cap from the turn adapter's connecting pins. Align the adapter with the meter body and insert into the body until it clicks securely in place. The turn adapter can be installed in only one position; never force it into the meter body.
3. Attach the meter's receptor head to the adapter by aligning the connecting pins with the desired connecting-pin terminal. Front-position or reversed-position terminals can be selected.

CARE AND STORAGE

- Do not subject the meter to shocks or vibrations.
- Do not press on or damage the liquid-crystal display window.
- If the meter is used in temperatures higher than 40°C (104°F) or lower than 0°C (32°F), operation may be unsatisfactory.
- Do not leave the meter in places subject to high humidity or temperatures higher than 55°C (130°F), such as inside a locked motor vehicle, or lower than -20°C (-5°F).
- Do not leave the meter in sunlight or near sources of heat, such as stoves, strong lights, etc.
- If the meter is placed or used in direct sunlight for a prolonged period of time, the display window will turn black. In this case, remove the meter from the light and the display will slowly return to normal. To use the meter in sunlight, attach Adapter Cord MA-1 or MA-2 between the receptor head and meter body, and place the body away from the light.
- When using an Adapter Cord, avoid noise sources, such as motors, as they may cause inaccurate measurement.
- Never attempt to disassemble the meter. Any repairs necessary should be made only by an authorized Minolta service facility.
- When dirty, the meter may be wiped with a silicone-treated cloth or other clean, dry cloth. Do not allow alcohol or any chemicals to touch the meter's surface.
- When the meter is to be stored, place it in its original packaging, then store in an air-tight container with a dehumidifying agent, such as silica gel.

TECHNICAL DETAILS

| | |
|---------------------------------------|--|
| Type: | Hand-held dual-function light-source colorimeter with CIE-standard digital readout by microprocessor and liquid-crystal display |
| Receptor: | 3 silicon photocells filtered to detect primary stimulus values for blue, green, and red light |
| Spectral response: | Closely approximates CIE (Commission Internationale de l'Eclairage) colorimetric Standard Observer curves ($\bar{x}_{2\lambda}$, \bar{y}_{λ} , and \bar{z}_{λ}) |
| Measuring modes and chromatic system: | Yxy (CIE 1931) and Yu'v' (CIE 1976) for chromaticity; $\Delta u'v'$, $\pm\Delta(Yxy)$, and $\pm\Delta(Yu'v')$ for color deviation |
| Color deviation mode: | One channel for memory of reference color (measured or inputted); measured value compared by microprocessor and color deviation displayed on LCD |
| Calibration standard: | PRESET: Minolta calibration standard VARI: User's selected calibration standard |
| Display: | LCD type; 3 digits with decimal and unit identifications as applicable; desired readout selectable by depressing appropriate key before/after reading made; "E9" appears on display when measured value is out of display range; display cancels approx. 3 minutes after last control released |
| Measuring range: | 5.1 – 32,700 lx; display blinks when measured value under range, "E0" appears on display when measured value over range |
| Repeatability: | Chromaticity (x, y): ± 0.0005 |
| Controls: | Measuring button, chromaticity-mode selector key, data-selector key, increase key, decrease key, function key, data-output key, calibration-selector switch, deviation-setting switch |
| Terminals: | Remote-control socket, data-output terminal |
| Data output: | 1-bit serial, open collector; remote-control operable |
| Electronic components: | Hermetically sealed microprocessor chip; custom-designed liquid-crystal display; gold-plated data-out and receptor-head plug contacts |
| Power source: | One 9v battery (Eveready 216 or equivalent) |
| Accessories: | CRT-reading hood, calibration cap, turn adapter, remote-control plug, data-output cord, case, strap |
| Dimensions: | 195 x 72 x 39mm (7-11/16 x 2-13/16 x 1-9/16 in.) |
| Weight: | 290g (10-1/4 oz.) without battery |

Specifications subject to change without notice

MEMO

Minolta Camera Co., Ltd.

Minolta Camera Handelsgesellschaft m.b.H.

Minolta France S.A.

Minolta (UK) Limited

Minolta Austria Gesellschaft m.b.H.

Minolta Nederland B.V.

Minolta (Schweiz) GmbH

Minolta Svenska AB

Minolta Corporation

Head Office (Meter Div.)

Minolta Canada Inc.

Head Office

Minolta Hong Kong Limited

Minolta Singapore (Pte) Ltd.

30, 2-Chome, Azuchi-Machi, Higashi-Ku, Osaka 541, Japan

Kurt-Fischer-Strasse 50, D-2070 Ahrensburg, West Germany Phone: 04102-702-357 bis, rue d'Estienne d'Orves, 92700 Colombes, France

1-3 Tanners Drive, Blakelands North, Milton Keynes, MK14 5BU, England

Amalienstraße 59-61, 1131 Wien, Austria

Zonnebaan 39, Postbus 264, 3600 AG, Maarssenbroek-Maarssen, The Netherlands

Riedhof V, Riedstrasse 6, 8953 Dietikon-Zürich, Switzerland

Brännkyrkagatan 64, Box 17074, S-10462 Stockholm 17, Sweden

101 Williams Drive, Ramsey, New Jersey 07446, U.S.A. Phone: 201-825-4000

1344 Fewster Drive, Mississauga, Ontario L4W 1A4, Canada

Room 208, 2/F, Eastern Center, 1065 King's Road, Hong Kong

10, Teban Gardens Crescent, Singapore 2260

Through The Years & Around The World: A CED Sponsored Learning Fair Providing Age-Specific & Culturally Competent Care at St. Joseph's



Enhancing Jobs & Advancing Education

At St. Joseph's we care for patients of all ages (from neonates to geriatrics) and many different cultures. With this comes the need for all direct care providers to be knowledgeable and skillful (or as JCAHO would say...competent) about differences in the care of patients of varying ages & cultures. How do we assess a 3 year-old differently from a 12 year-old? How do we insert a peripheral IV in an 85 year-old compared to a 35 year-old? How best to teach a 10-year old about their asthma medication? How to communicate effectively with a patient or colleague from another country?

Directions: Review each station with content related to your job at St. Joseph's. Note that you might not provide care to all ages of patients. Complete the educational activity (fishbowl question, post-test, etc.) then have the educator at the station sign the checklist. Have fun learning about the great ways we care for patients at St. Joseph's.

| TOPIC | DATE COMPLETED | INSTRUCTOR SIGNATURE |
|--|----------------|----------------------|
| GROWTH & DEVELOPMENT | | |
| Erickson's Developmental Tasks; Developmental Stages | | |
| AGE-SPECIFIC COMMUNITY RESOURCES FOR DISCHARGE PREPARATION & TEACHING | | |
| Culturally Competent & Age-specific Patient Education, Identifying Community Resources, Identification & Reporting of Abuse: elder, child, domestic violence | | |
| INFANT, TODDLER, PRE-SCHOOL, SCHOOL AGE & ADOLESCENT | | |
| Assessing Age-specific Clinical Data, Performing Age-specific Treatments, Age-appropriate Communication/interactive Skills, Involvement of Family &/or Significant Other In Plan of Care | | |
| ADULT | | |
| Assessing Age-specific Clinical Data, Performing Age-specific Treatments, Age-appropriate Communication/interactive Skills, Involvement of Family &/or Significant Other In Plan of Care | | |
| GERIATRIC | | |
| Assessing Age-specific Clinical Data, Performing Age-specific Treatments, Age-appropriate Communication/interactive Skills, Involvement of Family &/or Significant Other In Plan of Care, Aging Sensitivity, Spirituality of Aging | | |
| PHARMACY SERVICES | | |
| Drug Therapy in the Elderly; Pediatric Medication Administration | | |
| CULTURALLY COMPETENT CARE | | |
| Definitions of Culturally Competent Care, Dimensions of Culture, Behavioral Health Cultural Competence PI Team, Working With An Interpreter, Pastoral Care Resources | | |

Once you have completed all stations, share 1 example of how you have recently provided age-specific & culturally competent care on the easels by the stage & participate in the free raffle!

Learner Signature: _____ **Job Title** _____ **Date:** _____

PLEASE GIVE THIS RECORD TO YOUR SUPERVISOR. **Department** _____