



# OCTT

## Opti-Cam Termination Tool Operating Instructions

© Panduit Corp. 2015

### OCTT TOOL USE

This tool is intended to be used to terminate Panduit OptiCam connectors. The tool emits a laser beam, which, when used in conjunction with patch cord (sold separately), creates a glow effect from the connector which aides in proper connector termination.

Contact Panduit Corp. for a list of available replacement and additional parts for OptiCam connector products.

Complies with IEC 60825-1 Ed. 2 (2007). Complies with FDA performance standards for laser products except for deviations pursuant to Laser Notice No. 50, dated June 24, 2007.

### TECHNICAL SPECIFICATIONS

Recommended use:	With available patchcords only
Laser Diode type:	Class 1M Laser product
Power Supply:	2 type AAA - 1.5 volt Alkaline batteries
Battery Life:	Approx. 15 hours of continuous use
Operating temperature:	32° F (0° C) to 104° F (40° C)
Overall Dimensions:	2.0" H x 1.8" W x 6.7" L (52mm H x 47mm W x 170mm L)
Weight:	4.7 oz (133 g) without batteries



### ⚠ WARNING

Read and understand all of the instructions and safety information in this manual before operating this tool.

Failure to observe this warning can result in bodily injury.

### IMPORTANT

**DO NOT remove any labels from this tool.**

### COMPLIANCE LABEL

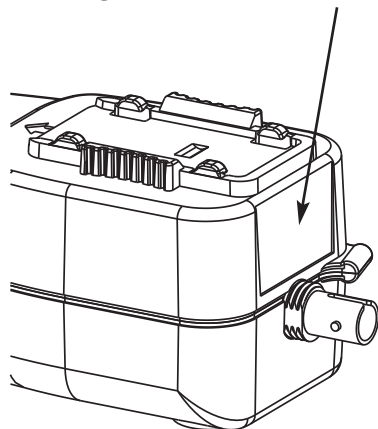

**Complies with FDA performance standards for laser products except for deviations pursuant to Laser Notice No. 50, dated June 24, 2007.**

COMPLIANCE LABEL

LASER LIGHT

**DO NOT VIEW DIRECTLY WITH OPTICAL INSTRUMENTS  
CLASS 1M LASER PRODUCT**

E-mail:  
techsupport@panduit.com

**PANDUIT**  
www.panduit.com

Panduit Corp.  
16530 W. 163rd St.  
Lockport, IL 60441 U.S.A.  
Technical Support  
Tel: 1-888-506-5400, ext. 83255

## ⚠ CAUTION

**Caution** - Use of controls or adjustments or performance of procedures other than those specified herein may result in hazardous radiation exposure.

- **Never** point the laser into the eyes of others.
- **Do Not** stare directly at the laser beam.
- **Do Not** set up tool to work at eye level or operate the tool on a reflective surface as the laser could be projected into your eyes or the eyes of others.

Viewing the laser output with certain optical instruments (for example, eye loupes, magnifiers, and microscopes) within a distance of 3.9" (100 mm) may pose an eye hazard.

**Always** turn the laser **off** when it is not in use or is left unattended for a period of time. Remove the batteries when storing for an extended period of time to avoid damage to the tool should the batteries deteriorate.

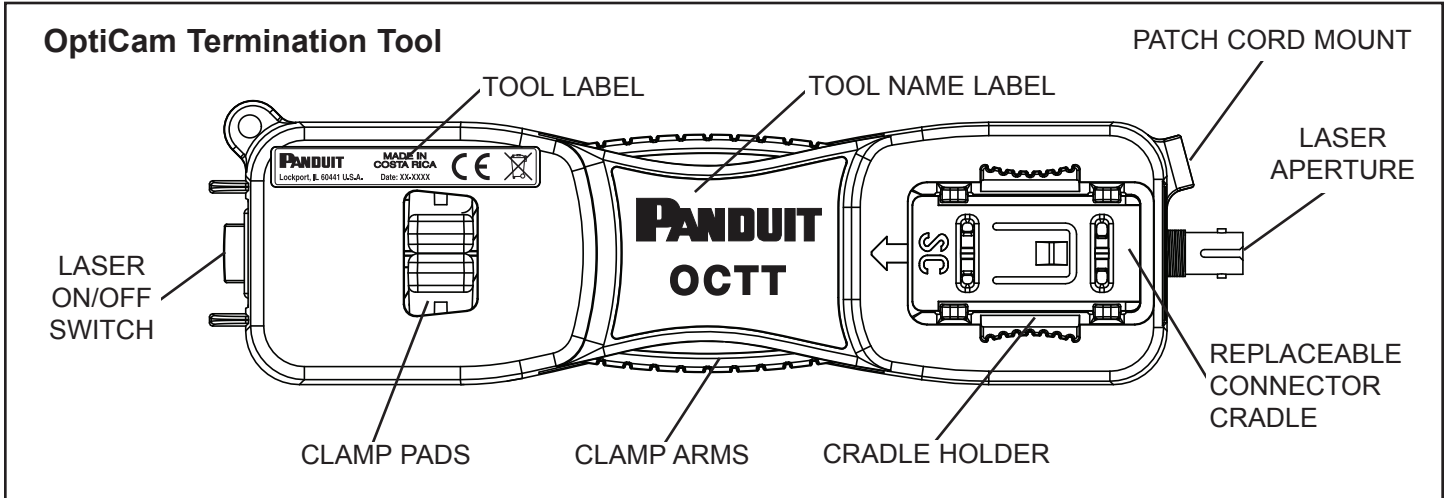

## How to use OptiCam Termination Tool:

### 1. Install Batteries

Open compartment on bottom of tool by pulling latch toward door and pivot upward, removing door. Place 2 AAA Alkaline batteries in the tool following the "+" and "-" directions in the battery compartment. Replace door and press on latch to assure the door is fully closed.

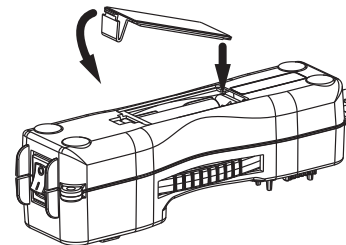

### 2. Attach Patch Cord

Select proper patch cord per connector to be terminated.

Make sure laser switch is in the "O" position. Remove protective dust cover from laser. Insert ST receptacle end of patch cord into laser aperture making sure to align tabs. Rotate barrel of ST connector clockwise to lock in place.

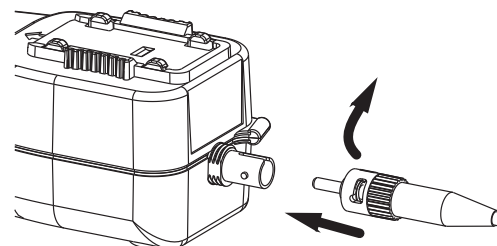

**3. Insert Connector Cradle**

Select cradle per connector type to be terminated. Align cradle with cradle holder and slide cradle under tabs of cradle holder until it stops.

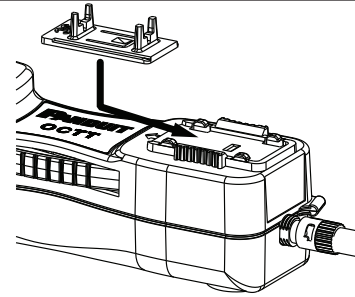
**4. Insert Connector into Cradle**

Based on the type of connector to be terminated, follow the insertion process supplied with the connector.

**5. Attach Patch Cord to Connector Ferrule**

**NOTE: During insertion, the ferrule adapter end must be in-line with the connector ferrule, NOT at an angle.** While holding connector still, slide the ferrule adapter end of the patchcord over the connector ferrule until it stops. To maximize VFL patchcord life, avoid side-loading the ferrule adapter end during insertion and testing.

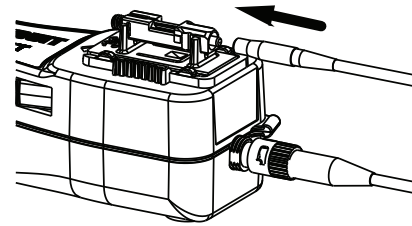
**6. Strip and Cleave Fiber, and Apply Insertion Mark**

Based on the type of connector to be terminated, follow the strip and cleave process supplied with the connector.

**7. Insert Fiber**

Insert fiber until it stops on the fiber stub. Use the insertion mark as a guide.

Based on the type of connector to be terminated, follow the insertion process supplied with the connector.

**8. Clamp Cable**

Squeeze both clamp arms to open clamp pads. Push cable between the clamp pads and release clamp arms.

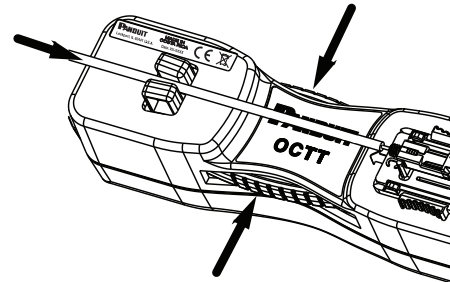
**9. Shuttle Cradle Holder**

Grip cradle holder by grip pads and slide cradle holder towards the cable until it stops. Detent mechanism will hold cradle holder in place creating a bow in the cable.

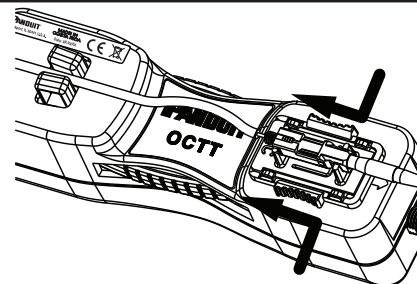
**10. Turn On Laser**

On the end of the tool, toggle the switch to the "I" position. If the fiber is in the correct position after this step, a multi-mode connector typically will either be dark or glow very dimly, and a single-mode connector will typically glow moderately.

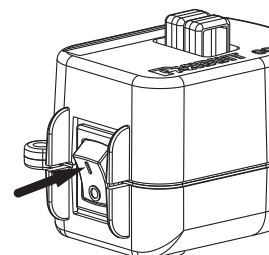

**11. Cam the Connector**

Cam the connector, the glow coming from the connector cam region should dim or remain dark. If not, turn the laser off and uncam the connector. Pull the fiber back slightly and then gently urge it forward until it stops on the stub fiber. (Re-check to make sure the insertion mark is near the back of the connector.) Turn the laser on and re-cam the connector, it should dim or remain dark. If not, turn off the laser and repeat the process starting at Step 6.

**12. Turn Off Laser**

Toggle the switch to the "O" position.  
While holding connector in place, remove patch cord from terminated connector's ferrule.

**13. Place the Dust Cover on the Patch Cord (Optional)****14. Unclamp Cable**

Squeeze both clamp arms to open the clamp pads. Remove cable from between the clamp pads and release the clamp arms.

**CAUTION: DO NOT** pull on cable while the connector is still held in place by the cradle.  
Doing so could break the fiber or create an unacceptable termination.

**15. Remove Connector from Cradle**

Based on the type of connector to be terminated, follow the connector removal process supplied with the connector.

**16. Reposition Cradle Holder**

Grip cradle holder by grip pads and slide cradle holder back to the pre-termination position. Repeat the process for another connector starting at Step 4.

**17. Store Tool**

After all connector terminations are complete, rotate barrel of ST connector counter-clockwise and pull connector free from laser receptacle. Replace dust cover over laser aperture to protect laser. Place tool in protective case.

**Care and Handling**

- Laser tools are precision instruments, which should be handled with care.
- Avoid shock, vibrations, and extreme heat.
- Avoid dust and water that could obstruct laser.
- Keep laser tool dry and clean.
- Check batteries regularly to avoid deterioration.
- Remove batteries if the tool is to be stored for an extended period of time.

**Maintenance and Adjustment**

This tool contains no user serviceable parts.  
The Laser output is not user adjustable.  
Contact Panduit Corp. for service needs.

**Symbols**

This symbol indicates the need for separate collection of waste electrical and electronic equipment.

Separating electronic waste can halt the potential adverse effects on the environment and human health as a result of the hazardous substances in electrical and electronic equipment.

This waste should be returned to the proper collection facility.

