

# ROTALIGN® Ultra

The ultimate alignment system



**INVENTORS OF  
LASER SHAFT ALIGNMENT**

## ROTALIGN® Ultra sets new standards

*This modular platform is developed to perform shaft alignment, and a wide range of geometrical applications which include bore alignment, straightness and flatness measurement.*

### Program Manager

- Icons for direct access to applications and configurations
- User defined machine templates
- Individual user defined device configuration: languages, units, workflow, power management
- The resume function opens the most recent measurement file

### Design

- Robust, shockproof, scratchproof, dustproof and water resistant
- Ergonomic, compact and portable
- Optional disposable batteries

### Universal Ports

Receiver, mains charger and USB interface for peripheral devices – PC, printer, keyboard



(Actual size, straps not shown.)

### Power Supply

- Heavy-duty rechargeable Li-Ion battery
- Mains power
- Optional disposable batteries

# for powerful performance

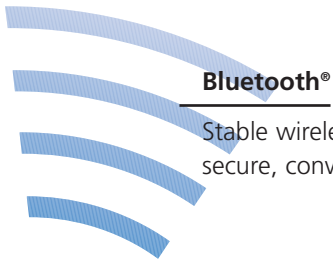

## **Bluetooth®**

Stable wireless data transmission ensures secure, convenient and flexible operation.

## **Display**

Transflective backlit coloured screen displays high quality images under various lighting conditions.

## **Keyboard**

- Backlit alphanumeric keys
- Conveniently positioned navigation, data entry and function keys
- Sealed for industrial use

## **Computer stand**

Sturdy removable foot for positioning of the computer



## **LED indicators**

The Blue, Green, Yellow and Red LEDs indicate alignment condition and laser adjustment. Two additional LEDs monitor both the Bluetooth® communication and battery statuses.



# At a glance

## Accurate alignment saves a lot of money!

More than 50% of damages to rotating machinery can be directly related to misalignment. Alignment using ROTALIGN® Ultra results in the increase of machine availability and reliability, as well as in the reduction of maintenance costs.

- Increased productivity as a result of reduced machine downtime
- Reduced spare parts consumption and storage costs
- Protection of asset through the reduction of vibration
- Reduced energy consumption

## Highlights

- Scratch resistant backlit colour screen
- Backlit alphanumeric keyboard
- Bluetooth® Communication
- USB connection for peripheral devices: PC, printer, keyboard
- Heavy-duty lithium-ion rechargeable battery
- Customization
- Intuitive user guidance
- Intelligent word completion
- Patented single beam technology
- Patented continuous sweep measurement mode
- Alignment of both vertical and horizontal machines
- Machine train alignment for up to 14 machines
- Soft foot measurement, diagnosis and correction
- Thermal growth evaluation
- Rigid pre-assembled universal brackets
- Windows based PC software for job set-up, archival and reporting

**PRÜFTECHNIK Alignment Systems** the inventors of the laser shaft alignment technology, possess well over 200 patents worldwide. These patents have been incorporated in our alignment systems as standards. ROTALIGN® Ultra benefits from these innovations, making the alignment of rotating machinery simpler than ever before.

## Measurement flexibility

### Single laser and 5-axis receiver

The patented single laser beam technology, the dual position detectors and the built-in electronic inclinometer allow the simultaneous measurement of the shaft rotation, both vertical and horizontal offset and angularity; eliminating any possible human error.

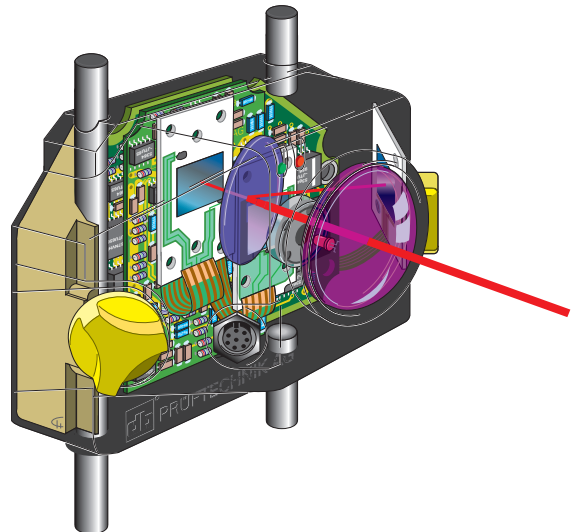

## Measurement Modes

### Patented continuous sweep mode

By turning the shafts from any position and in either direction, this patented mode automatically starts the continuous measurement of the alignment condition. The continuous taking of the readings leads to a quick and accurate result. A shaft rotation of only 60° is required; thus overcoming shaft rotation restrictions.

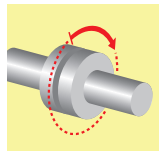

### Multipoint mode

For shafts that are mounted on all types of bearings. Measurements at any 3 or more positions over 60° rotation are required.

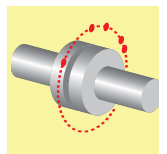

### Static mode

This measurement mode is used for vertical alignment. Measurement requires 3 or more of the 8 available measurement positions.

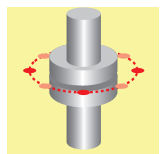

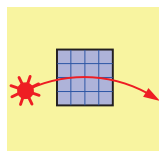

### Pass mode

Patented measurement mode for uncoupled and/or non-rotatable shafts.



## 3-key alignment







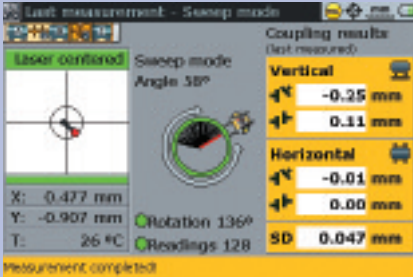

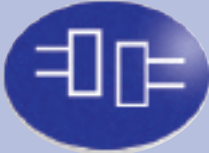

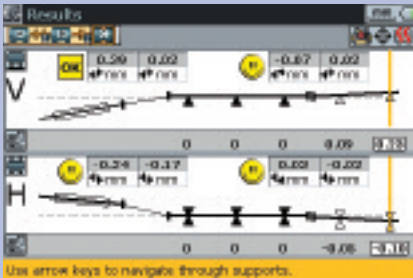

**Dimensions**

- Horizontal and vertical alignment
- Train alignment with up to 14 machines
- Reusable files and templates
- Life-like graphics
- Coupling type (short, cardan, spacer)
- Target and thermal growth calculation
- Dynamic/customized tolerances

**Measurement**

- 4 laser and 5 dial guage set-ups measurement modes
- Coupling results displayed instantly
- Detector extend range eliminating rough alignment
- Standard deviation measurement evaluation
- Editable ellipse
- Degrees of measured rotation
- Measurement table
- History protocols alignment sequences with labels e.g. as found, as left

**Results**

- Horizontal and vertical results
- Graphical display of shaft centerlines and coupling results in one screen
- Selection of any combination of static feet
- Tolerance envelops, smiley, and LEDs for the evaluation of the alignment condition
- Alignment details

## PC software for job set-up, archival and reporting

The Alignment Explorer is the software platform that allows communication between a PC and current PRÜFTECHNIK alignment instruments. The ROTALIGN® Ultra READER and EDITOR software operate under the Alignment Explorer. The READER is a free software which supports one-way communication allowing measurement data to be transferred to a PC for viewing, printing and archiving in B&W.

The optional EDITOR supports two-way communication allowing advance file preparation as well as editing, printing and archiving in color.

Professional measurement reports can be customized to include company information and logo. Measurement results and a linked photo can be presented in HTML format to be viewed with any browser.

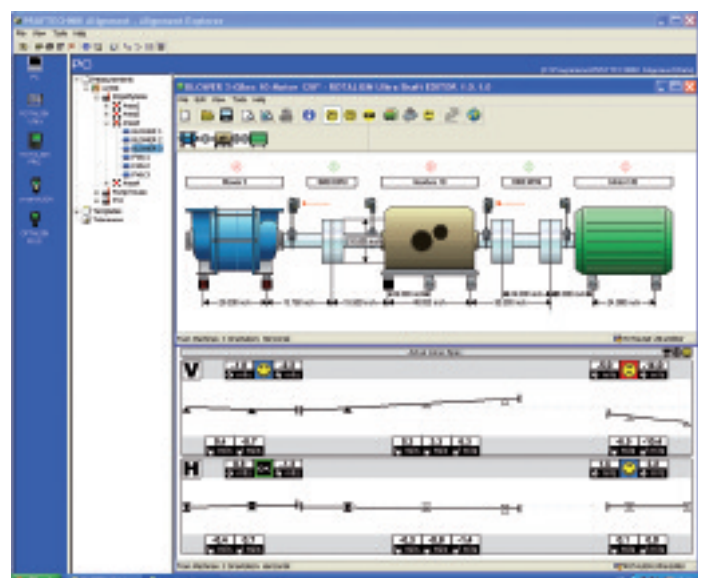

Machine train alignment for up to 14 machines

## User friendly guidance

- Status line
- Workflow assistance
- Context sensitive help text
- Word completion
- Short cuts using data entry keys

## Alignment file overview

- Displays entire machine train
- Shows the alignment condition
- Displays file name and current user
- Shows file modification date

## Intuitive menu operation

- Screen related context menu
- Global menu



(Illustration shows device in 'Live Move'.)



## Evaluation of the alignment condition

- Interactive tolerances
- Speed related tolerance
- Customized tolerances
- User defined maximum values

# with intuitive user interface

## Quality of measurement

- Unlimited number of measurement points
- Measurement points can be taken at any position over the full shaft rotation
- The standard deviation for each measurement is shown



## Live Move

- Both horizontal and vertical live move monitored simultaneously
- Arrows indicate the direction for feet corrections
- The LEDs, smiley, and tolerance envelopes, show, in real time, the current alignment condition in comparison to the tolerance limits

## Optimization of corrections

- Minimum movement of machines by selecting any combination of fixation points

## Straightforward alignment results

- Logical sequence of entering machine dimensions, carrying out measurements, and viewing the results
- Changes can be made at any time by simply pressing the appropriate function key

## Soft foot analysis

- Measurement
- Diagnosis
- Customized soft foot tolerance

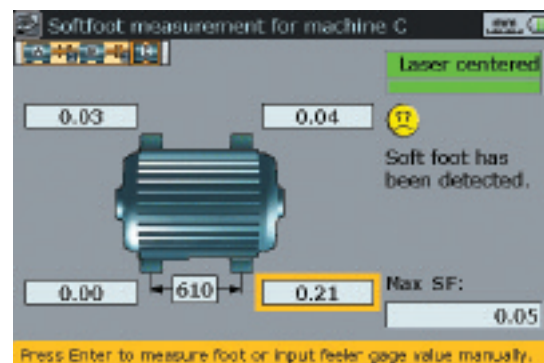

## Further optional applications with ROTALIGN® Ultra



### Bore alignment

Alignment measurement of bearing shells and bores

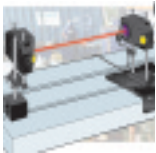

### Straightness

Measure straightness of beds, ways and other workpieces

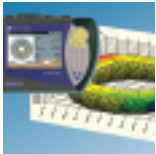

### Flatness

Determine the surface geometry of a wide range of surfaces



### Carrying case

ABS, drop tested ( 2 m / 6 ½ ft.),  
Case features 2 key locks and 1 combination lock  
Dimensions 565 x 375 x 193 mm (22.2 x 15 x 7.6 in)  
Weight, including all standard parts approx. 9 kg (19.8 lb)

## ROTALIGN Ultra technical data

### Computer

Intel XScale® Processor, 64 MB RAM, 64 MB Internal Flash,  
64 MB Compact Flash Memory, power saving management

### Display

Transflective (sunlight-readable) backlit color graphic display  
(1/2 VGA, 480 x 320 Pixel, 118 mm x 80 mm), contrast and illumination  
(0 ... 70 cd/m²) adjustable

### Power supply

Li-Ion rechargeable battery (7,2 V/6,0 Ah),

Operating time: approximately 25 hours\*

Disposable batteries (6 x 1,5 V [IEC LR 14]),

Operating time: approximately 12 hours\*

\* Typical use: 25% measurement, 25% computation and 50% "sleep" mode

Mains power: (110 V/220 V AC)

	Computer	Laser	Receiver
Environmental protection:	IP 65	IP 67	IP 67
Temperature range (storage):	-20 °C to 60 °C	-20 °C to 60 °C	-20 °C to 80 °C
Temperature range (operation):	0 °C to 45 °C	0 °C to 60 °C	0 °C to 60 °C
Dimensions:	243 x 172 x 61 mm	105 x 67 x 47 mm	105 x 67 x 47 mm
Weight:	1 kg (without battery)	165 g	190 g
Maximum measurement distance:		10 m	
CE conformity:	EN 61326 (general), EN 55022 (emission), EN 61000-4-2, -3, -4, -5, -6, -11 (interference)		

### Interfaces

USB host/slave (for printer, keyboard or PC communication),

I-Data-socket (for receiver), RS232 (serial for receiver),

Bluetooth® communication

### Laser

GaAlAs semiconductor laser, Beam divergence < 0,3 mrad, Beam power < 1 mW, Laser safety class 2 (FDA 21CFR 1000 und 1040), Power supply 9V block battery (IEC 6LR61, alkali or lithium)

### Receiver

5-axis receiver: 2 planes (4 displacement axes), 1 inclination 360°, protection from ambient light, unlimited dynamically extendible measurement area, resolution 1 µm (0.04 mil) and angular 10 µRad, error < 2%, error rotation angle < 2°, measurement rate approx. 20 Hz



ROTALIGN® is a registered trademark of PRÜFTECHNIK Dieter Busch AG. No copying or reproduction of this information, in any form whatsoever, may be undertaken without express written permission of PRÜFTECHNIK AG. The information contained in this leaflet is subject to change without further notice due to the PRÜFTECHNIK policy of continuous product development. PRÜFTECHNIK products are the subject of patents granted or pending throughout the world.  
© Copyright 2006 by PRÜFTECHNIK AG. Printed in Germany ALI 9.842.02.06.G

### A company of the PRÜFTECHNIK Group

PRÜFTECHNIK  
Alignment Systems GmbH  
Oskar-Messter-Straße 15  
85737 Ismaning, Germany

Tel.: +49 (0)89/99 61 6-0  
Fax: +49 (0)89/99 61 6-100  
E-Mail: info@pruftechnik.com  
www.pruftechnik.com