

- Simplify Installation, Troubleshooting & Home Certification of Both Residential and Business Installations
- 1 GbE SFP Optical & Electrical Ethernet Throughput Testing and 802.11 b/g/n (2.4/5 GHz) Wireless Testing
- Intuitive Color Touch Screen with Simple Pass/Fail Indicators Reduce Installer Entry Errors and Improves Decision Making
- Next-Generation Autotest Apps Streamline Certification
- Convenient Multiple Standard Tests in a Single Autotest App Help to Standardize Tech Processes & Procedures



**Business service installation, troubleshooting and verification all in one compact, powerful device**

### The Standardization Solution

Trilithic's 720 DSP™ conveniently combines CATV and Gigabit Ethernet testing along with 802.11 b/g/n wireless in a single meter for troubleshooting and installation of both residential and business services.

Multi-service verification can now be achieved with one instrument containing everything needed for service, business, or residential installations. Eliminate the need for multiple instruments in most business services with Gigabit Ethernet Throughput testing and save capital expenditures at the same time.

Tailored for the challenges faced by installers, contractors and service techs, the 720 DSP comes equipped with all of the powerful troubleshooting tools for the experienced tech, yet helps simplify decision making and streamline standard processes and procedures for the more novice tech. This results in more efficient

technicians, greater overall system health and allows techs to continue using the same meter as they become more experienced.

### Gigabit Ethernet Testing

Used in combination with either the MetroNet 5001™ or TLB-GbE™, the 720 DSP can achieve throughput testing speeds of up to 1 GbE using either dedicated test port.

The 720 DSP can perform either roundtrip or one-way measurements of Key Parameter Index (KPI) for full Ethernet service testing. With constant payload testing for Layer 2 through Layer 4, the 720 DSP is built for verification of both Ethernet Service Level Agreement (SLA) and Quality of Service (QoS) metrics.

### Next Gen Features

The 720 DSP features an intuitive color touch screen interface, simple pass/fail indicators, and powerful autotest apps to streamline certification and make the technician's job easier.

Everything about this next-gen meter was built with the business technician in mind, from the long battery life and quick charge time to its unique built-in LED flashlight and glow in the dark keypad for those dark cramped spaces.

With its next-generation smart device technology, the 720 DSP is the easiest to use, most feature-rich, best-performing meter available for installation and troubleshooting of business customer accounts.

**innovative technology to keep you a *step ahead***

**AVAILABLE MODELS:**

- 720 DSP - US (6 MHz)  
P/N 2011703XXX
- 720 DSP - EURO (6/8 MHz)  
P/N 2011704XXX

**OPTIONS:**

- Bluetooth Communications Adapter (BCA)  
P/N 2011670002
- QAM Error Vector Spectrum (EVS) Analysis  
P/N 0930207006
- Source Generator (SRC)  
P/N 0930207007
- Traffic Control Plus (TCP)  
P/N 0930207009
- CM Sweep (CMS)  
P/N 0930207008

**STANDARD INTERFACES:**

- RF Test Port (F-Type)
- DOCSIS 3.0 modem 8x4 (100/304 Mbps)
- RJ45 Management Port (10/100 Mbps)
- Cable Modem Thru RJ45
- RJ45 Electrical Ethernet & SFP Optical Ethernet Test Ports (10/100/1000 Mbps)
- 802.11 "b/g/n" 2.4/5 GHz Wi-Fi
- USB 2.0 Flash Drive Port

**The 720 DSP supports a variety of functions, including:**

- Multi-user support
- Multi-language support
- Create jobs right on the meter
- Built-in web browser, real-time data transmission
- Interactive autotesting apps

**Simple Yet Powerful**

Providing the widest range of standard functions for an installer available today, the 720 DSP includes virtually all the testing options an installer or service technician needs to verify service quality and easily identify and fix problems in the field.



**STANDARD TESTING FEATURES:**

- Return Spectrum Analysis (4 to 110 MHz)
- Level Measurement
- C/N Measurement
- QAM Measurement (MER/BER/Constellation/EQ)
- Complete Channel Plan Scan with Tilt Measurement
- Ping, Trace Route, VoIP & Throughput Measurements
- Cable Modem Statistics
- Full Spectrum Analysis (5 to 1000 MHz)
- Frequency Domain Reflectometer
- Analog & Digital HUM Measurement
- Upstream Linear Distortions Measurement
- Auto Discovery of Channel Plans

### Autotest Apps

The 720 DSP features next generation autotest applications that practically walk the technician through a job. By performing standardized measurement tests at various required locations on the job site using user set test plans, channel plans and limit sets, the meter very clearly indicates (using color and symbols) what areas still need attention, before the technician leaves the job site.

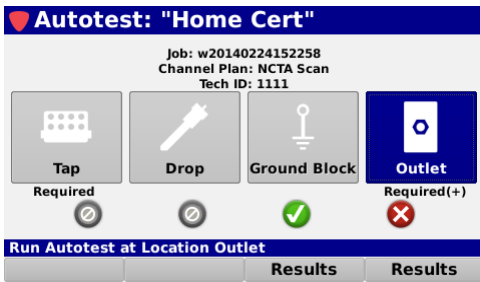

Multi-user support allows technicians that work in various territories to easily switch channel plans, standardized autotest apps, and test limits or login as a completely different user. Connecting to ViewPoint allows techs to upload job data in near real-time as well as transmit and receive channel plans, autotests, and firmware.

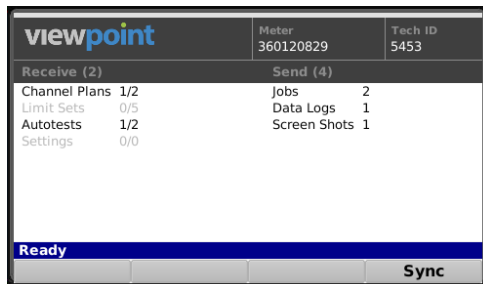

Leaving less room for entry error, this new, simple user interface can translate into less training and more efficient time in the field for techs. The 720 DSP comes equipped with all of the required troubleshooting tools for the advanced technician, it also offers a higher comfort factor for novice technicians, reducing decision making in the field, which can ultimately result in more productive work days and more satisfied customers.

### Justify ROI

Field operations managers can now easily verify that all of their technicians are performing the proper tests and are doing so at the right place and time—in near-real time. The potential benefits include identifying techs who need additional training, improving team performance, reducing truck rolls, and cutting operating costs.

At a higher level ViewPoint can deliver simple, standardized, system-wide reports and dashboards that can help a director or VP of technical operations view the entire operation at a glance to gain information that can be used to reduce service and repeat trouble calls.

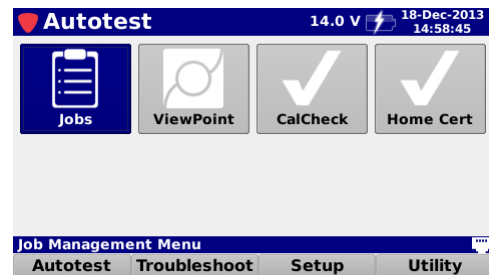

Essentially, this integrated system approach allows cable operators to see much more of their certification operations and use the information in practical ways. The insights can enable them to identify both localized problems and high-level system issues to make decisions based on a clearer understanding of their overall operations and the associated ROI.

Combining 720 DSPs in the field with the new ViewPoint WFM Module in the back office, managers can view the health of their entire system—in near real-time, for total RF installation management.

## STANDARD FEATURES

The 720 DSP includes all of the following features standard.

### Multiple User Profiles

- Allows up to 5 technicians to share a 720 DSP
- Each technician has his or her own profile, which loads in completely different sets of channel plans, autotest, etc.

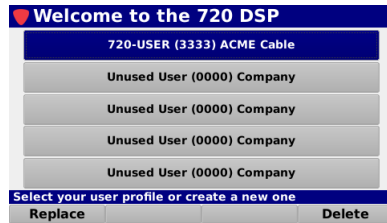

### Job Management

- Create and close out your jobs from this screen
- Shows what channel plan and how many tests have been run on a particular job

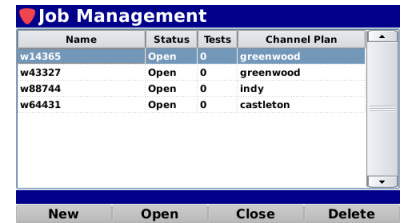

### Simple Network Management

- Choose between Ethernet, Wi-Fi, GigE, cable modem, or Bluetooth connection methods
- Provides connection details such as MAC, IP, gateway and DNS

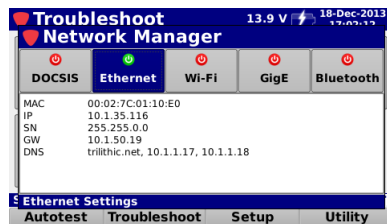

### LED Flashlight

- High intensity LED for working in dark spaces
- Control is provided through the Function menu for quick access from any screen

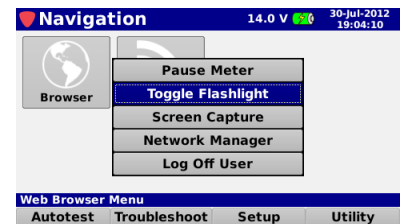

### Easy Setup & Configuration

- Global configuration settings can be applied to all users of the device while other settings can be tailored to suit each user
- Setting adjustments can be locked out using the ViewPoint software

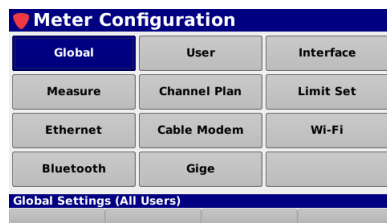

### Cable Modem Statistics

- Shows up to 8 downstream channels and 4 upstream channels
- Provides performance metrics for all downstream and upstream channels

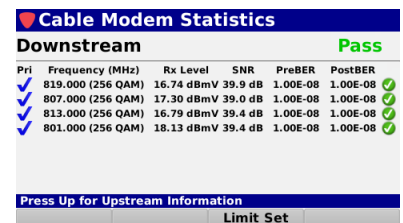

### N-Speed Wi-Fi with Survey Test Mode

- Built-in 802.11 "b/g/n" 2.4/5 GHz wireless adapter
- Actively view live signal strengths of Wi-Fi networks in the area
- Provides Wi-Fi details such as SSID, channel and power level

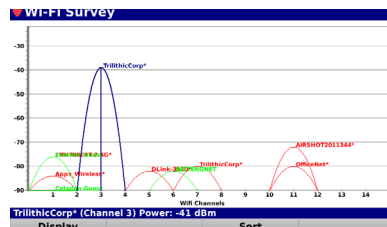

### SFP Optical Power Measurement

- Provides the ability to measure the optical power through the optical transceiver
- Provides link speed, wavelength, Tx power and Rx power measurements of active SFP connection

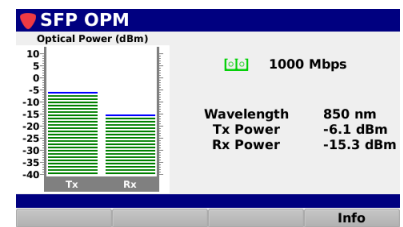

**STANDARD FEATURES (CONTINUED)**

The 720 DSP includes all of the following features standard.

**Convenient Firmware Updates**

- Easily update the meter firmware through the web or via USB to ensure you always have the latest features

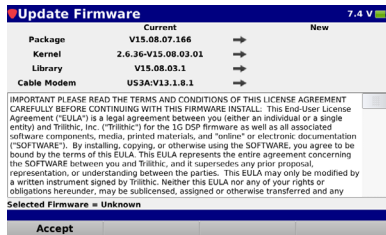

**INCLUDED MEASUREMENT FUNCTIONS**

The 720 DSP includes all of the following measurement functions standard.

**Analog Level Measurement**

- Shows the analog channel and its associated measurements
- Provides Pass/Fail results for limit sets

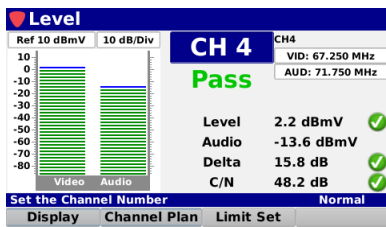

**Remote Access**

- Remotely access the meter using any active network connection
- Control and monitor almost any function of the meter from your PC, smart phone, or tablet



**Single Frequency Level Measurement**

- Shows the level of the analog carrier
- Displays the Carrier to Noise ratio of the analog carrier

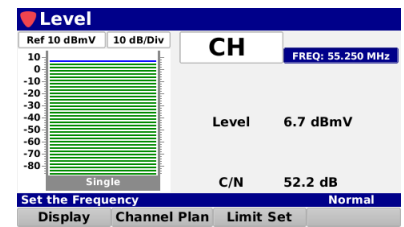

**Digital Level Measurement**

- Shows the level, MER and BER of a QAM channel
- Users can change the display to view BER over time, Equalizer Tap and Constellation

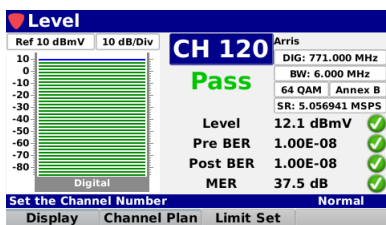

**QAM Constellation**

- Shows the constellation diagram of the specified QAM channel
- Shows the level, MER and BER and provides Pass/Fail results for limit sets

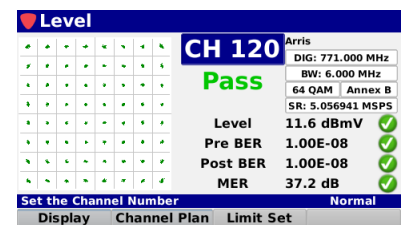

**Analog & Digital HUM Measurement**

- Measure the amplitude of 50/60 Hz, 100/120 Hz, and low frequency interference present on analog or digital channels
- Provides Pass/Fail results for limit sets

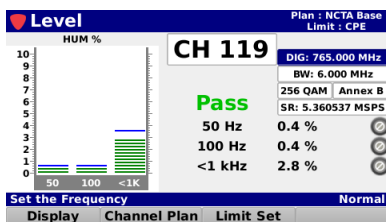

**Equalizer Tap Display**

- Displays the equalizer stress and whether the SCTE specification is being broken
- Shows the level, MER and BER and provides Pass/Fail results for limit sets

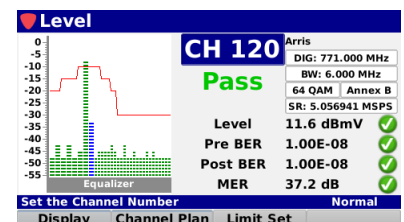

**INCLUDED MEASUREMENT FUNCTIONS (CONTINUED)**

The 720 DSP includes all of the following measurement functions standard.

**Bit-Error Rate Display**

- Shows the BER on a graph with an adjustable measurement period
- Shows solid green lines for pre-errors and solid red lines for post-errors

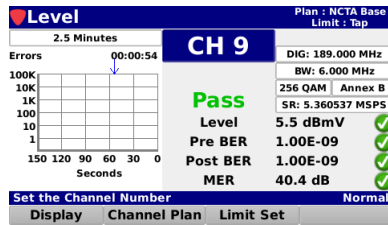

**Return Spectrum Measurement**

- Provides the ability to view raw return spectrum traces from 4 to 110 MHz
- Fast DSP spectrum snapshots give the user extreme speed to capture fast transients on the upstream

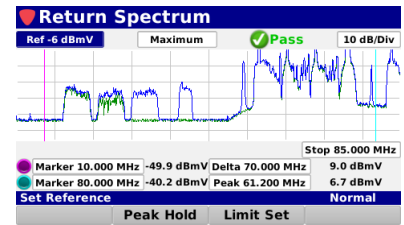

**Full Spectrum Measurement**

- Provides the ability to view raw forward spectrum traces from 5 to 1000 MHz
- Fast DSP spectrum snapshots give the user extreme speed to capture fast transients on the downstream

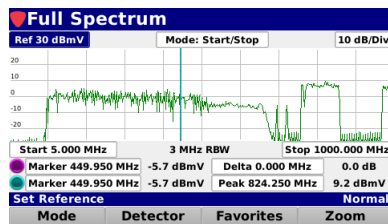

**Scan & Tilt Measurement**

- Full channel plan scan displays the frequency response of the entire channel lineup
- Provides Pass/Fail results for limit sets and color coded channels, green for digital and blue for analog
- Tilt shows the level difference between two selectable channels

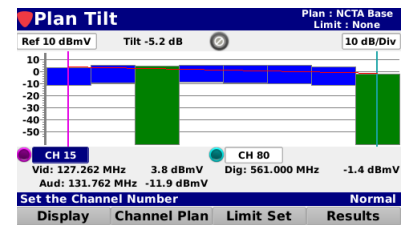
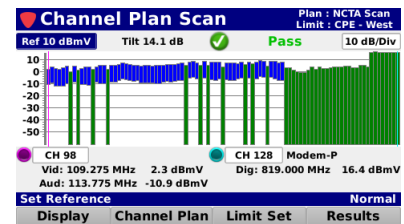

**Frequency Domain Reflectometer**

- Determine the distance to cable faults (opens, shorts, splitters, etc.)
- Events shown on a distance versus amplitude display
- Markers to identify the distance and loss at the source of the reflection.

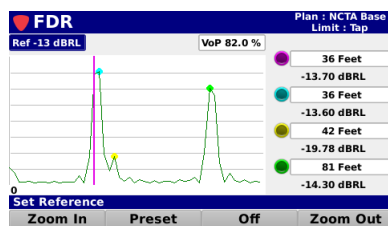

**Gigabit Ethernet Testing**

- Throughput testing speeds of up to 1 GbE using a dedicated test port
- Roundtrip or one-way constant payload testing for Layer 2-4 for verification of Ethernet SLA and QoS metrics

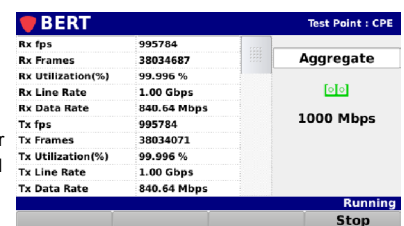

**OPTIONAL FEATURES**

The following optional features are available for the 720 DSP.

**Source Generator**

- Generate signals in the return path from 5 to 85 MHz
- Continuous wave (CW) or 16/32/64/128/256 QAM signal
- BER error injection for checking the bit stream

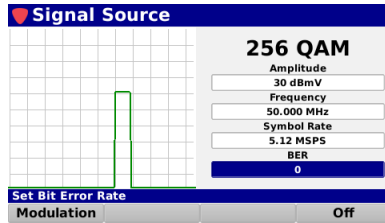

**Upstream Linear Distortions Measurement**

- Used to determine if equalization is hiding potential problems within the upstream
- View the pre-equalization of the upstream channel, the in-channel frequency response and group delay, and the distance to the EQ taps

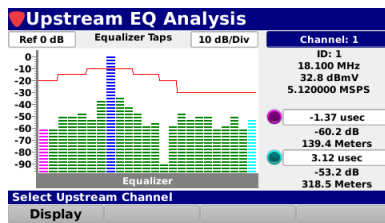

**CM Sweep (Patent Pending)**

- Uses the active cable modem built into the 720 DSP to align the upstream amplifiers
- No headend gear required, pre-EQ must be turned on at the CMTS

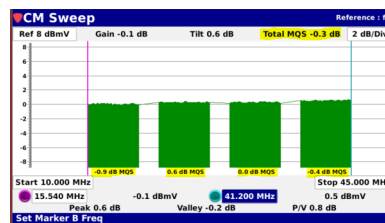

**Bluetooth Communications Adapter**

- Remote control of the meter via a Class II Mini Bluetooth Adapter (v2.1) with a 10 meter range
- Connect to an iPad that has device tethering enabled by the service provider

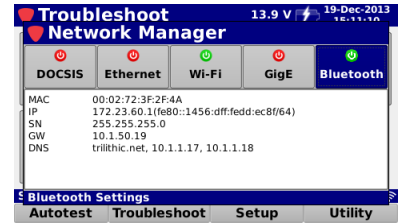

**QAM Error Vector Spectrum (EVS) Analysis**

- Tune to downstream QAM channels to display Error Vector Spectrum (EVS)
- Display the ingress underneath an upstream cable modem channel, or any bursty signal
- Includes TrafficControl

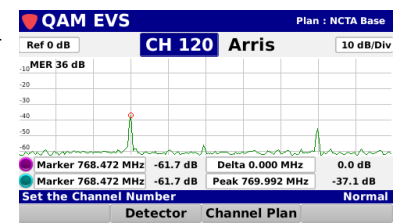

**Traffic Control Plus**

- Allows for a high-speed view of ingress in the upstream
- Heat map allows for simplified view of ingress hotspots

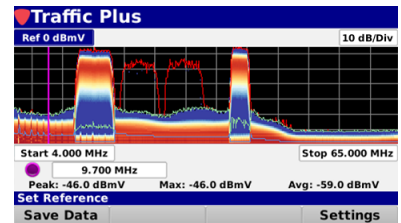

**FULL ETHERNET SERVICE TESTING**

The Gigabit Ethernet testing feature works in combination with a loopback device to perform BERT loopback measurements of Key Parameter Index (KPI) for full Ethernet service testing.

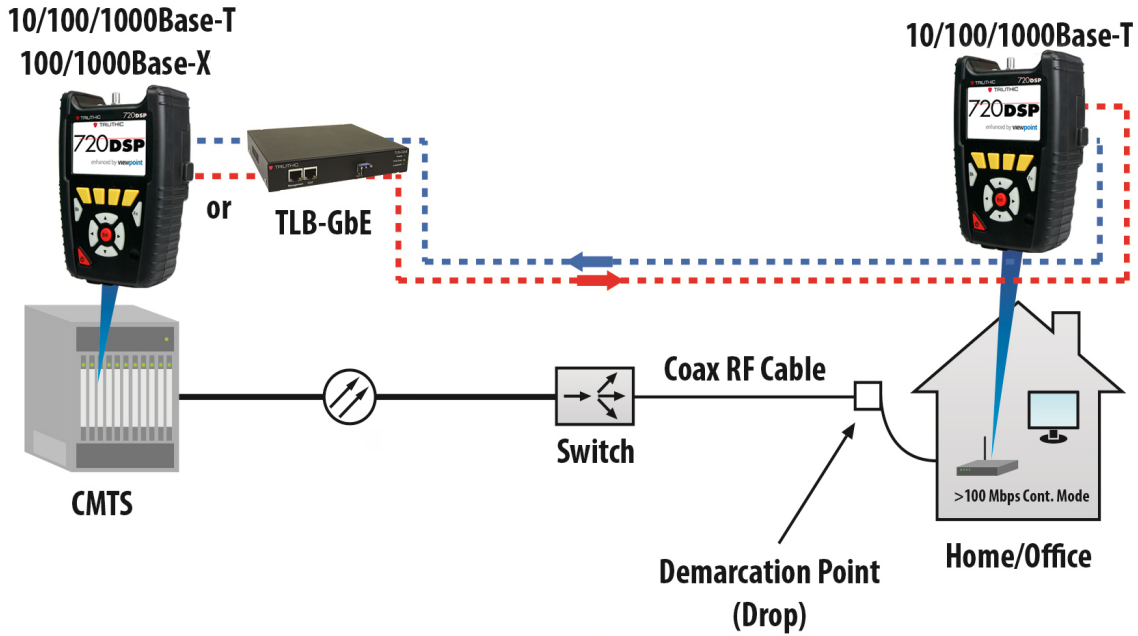



**TOTAL SYSTEM MANAGEMENT**

Combining the 180 DSP, 360 DSP, 720 DSP & 1G DSP meters in the field with the new ViewPoint Integrated Server in the back office, managers now have simplified access to intelligent management tools for monitoring, assessing and improving the efficiency of their total operation while making it even easier to obtain consistent, repeatable results that give supervisors that birds-eye view of the field for Total System Management.



By unifying an entire MSO's field operations in one convenient dashboard, managers can easily verify compliance and quality throughout the entire plant, either by home, system, region, division, or any other attribute from a billing system.

This simple and completely customizable integrated system of field analysis and reporting tools allows managers to watch over their entire field operations in one dashboard, comparing each location in the system, analyzing the overall health of their entire organization, and addressing concerns in near real-time.

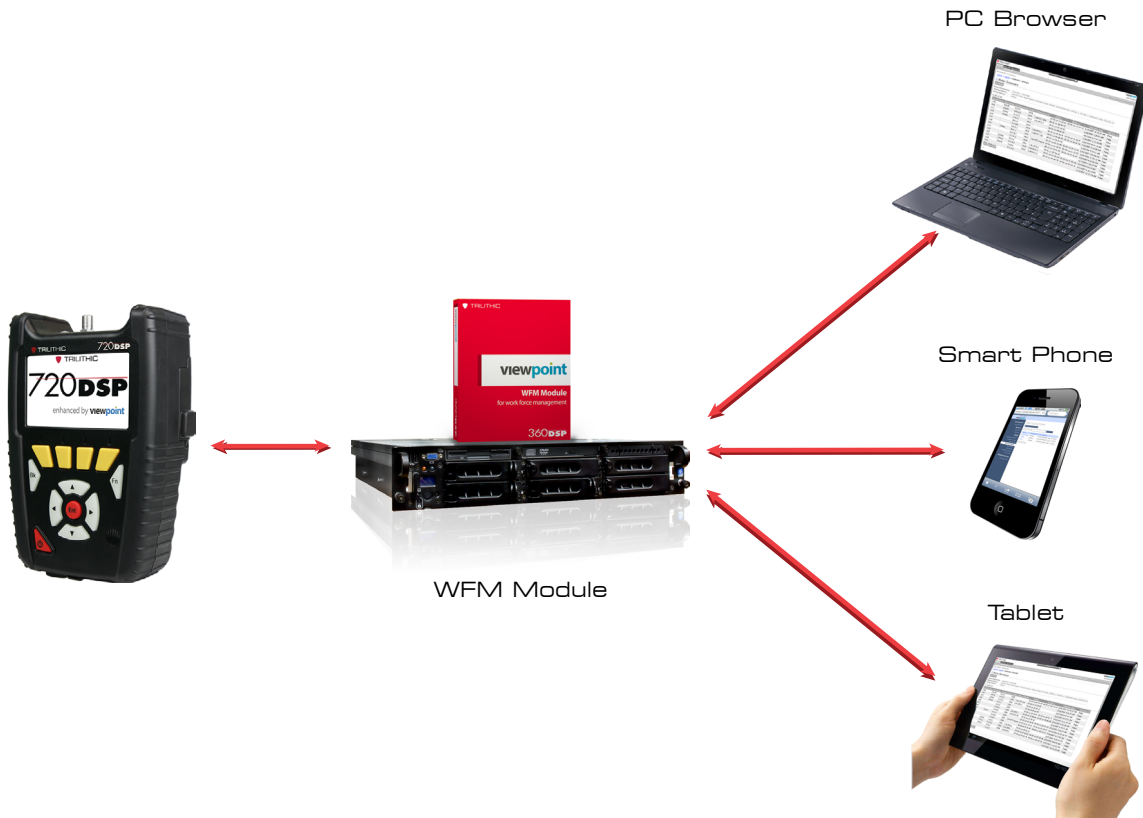

innovative technology to keep you a *step ahead*

**STANDARD MEASUREMENT SPECIFICATIONS**
**Level Measurement**

<b>Channel Bandwidth</b>	<b>US Models:</b> 6 MHz <b>EURO Models:</b> 8 MHz
<b>Amplitude Range</b>	-40 dBmV to +50 dBmV
<b>Modulation Types</b>	<b>Analog:</b> NTSC, PAL B/D/G/H/I/K/N & SECAM B/D/G/H/I/K <b>Digital:</b> 16/32/64/128/256 QAM Annex A, 64/256 QAM Annex B
<b>Analog Measurement Accuracy</b>	±0.75 dB @ 77 °F (25 °C) ±2.0 dB from 0 to 122 °F (-18 to 50 °C)
<b>Digital Measurement Accuracy</b>	±0.75 dB @ 77 °F (25 °C) ±2.5 dB from 0 to 122 °F (-18 to 50 °C)
<b>Resolution</b>	0.1 dB

**Spectrum Measurement**

<b>Frequency Range</b>	<b>Return Path:</b> 4 to 110 MHz <b>Forward Path:</b> 5 to 1000 MHz
<b>Resolution Bandwidth</b>	<b>Return Path:</b> 300 kHz <b>Forward Path:</b> 10, 30, 100, and 300 kHz 1 and 3 MHz
<b>Display Spans</b>	<b>Return Path:</b> 4 to 42 MHz, 4 to 65 MHz, 4 to 85 MHz or 4 to 110 MHz <b>Forward Path:</b> User-selectable in 1 kHz steps
<b>Display Scale</b>	1, 2, 5, or 10 dB/division
<b>Display Range</b>	8 vertical divisions (when marker bar is hidden)
<b>Spurious Free Dynamic Range</b>	60 dB @ 25° C (77° F) (+50 dBmV)
<b>Sensitivity</b>	<b>Return Path:</b> -30 dBmV (4 MHz to 110 MHz) <b>Forward Path:</b> -40 dBmV (50 MHz to 1 GHz)

**Digital Channel Measurement**

<b>Deep Interleave Compatibility</b>	Yes
<b>Downstream MER</b>	40 ±2 dB @ +6 dBmV RF Input Level 34 ±2 dB @ -6 dBmV RF Input Level
<b>Downstream BER</b>	<b>Method:</b> True BER, derived from code words not from MER <b>Standard:</b> ITU J.83 annex A, B, C <b>Range:</b> 1 E-7 to 1 E-9 @ -6 dBmV RF Input Level
<b>Symbol Rates</b>	≥ 2 msps; ≤ 6.952 msps

### Cable Modem Measurement

<b>Protocol Support</b>	DOCSIS 1.1 / 2.0 / 3.0 compliant (US & Euro DOCSIS 8x4) SNMP V1, V2c, V3 IEEE 802.3, 802.3u
<b>Compliance Certificates</b>	CE mark RoHS compliant CableLabs® wave 80 (DOCSIS 8x4)
<b>Receiver Demodulation</b>	<b>Demodulation:</b> 64 QAM, 256 QAM <b>Data rate:</b> Up to 304 Mbps with 8 downstream channel bonding (DOCSIS 8x4) Up to 400 Mbps with 8 downstream channel bonding (EuroDOCSIS 8x4) <b>Channel bandwidth:</b> 6 MHz (DOCSIS) 6/8 MHz (Dual mode 8x4) <b>Maximum modem input signal level:</b> 17 dBmV
<b>Transmitter Modulation</b>	<b>Modulation:</b> QPSK, 8 QAM, 16 QAM, 32 QAM, 64 QAM, and 128 QAM (SCDMA only) <b>Data rate:</b> Up to 108 Mbps with 4 upstream channels bonding <b>Frequency (edge to edge):</b> 5 to 42 MHz (DOCSIS) 5 to 65 MHz (EuroDOCSIS) Output level of CM can be controlled by CMTS through power ranging function <b>Step:</b> 1 dB

### Carrier-to-Noise Measurement (In-service, non-scrambled standard channels only)

<b>Minimum Input Level for Full Range</b>	+10 dBmV
<b>Dynamic Range</b>	50 dB
<b>Resolution</b>	< 0.5 dB

### Tilt Measurement

<b>Max Number of Carriers</b>	14 (dependent on favorite channel setup)
<b>High/Low Delta Resolution</b>	0.1 dB
<b>Scan</b>	Video, audio, pilot, and digital carriers

**Analog & Digital HUM** (In-service, non-scrambled standard channels only)

<b>Minimum Input Level</b>	0 dBmV
<b>Range</b>	0 to 5%
<b>Resolution</b>	0.1%
<b>Accuracy</b>	±0.5%

**Frequency Domain Reflectometer**

<b>Velocity of Propagation</b>	Adjustable from 60.0 to 99.0% in 0.1% increments
<b>Working Distance</b>	<b>Minimum:</b> 755 feet (230 meters) @ VoP of 60.0% <b>Maximum:</b> 1247 feet (380 meters) @ VoP of 99.0%
<b>Amplitude Range</b>	0 to -80 dBRL
<b>Distance Accuracy</b>	5 feet

**OPTIONAL MEASUREMENT SPECIFICATIONS**
**Source Generator**

<b>Modulation</b>	CW, 16 QAM, 32 QAM, 64 QAM, 128 QAM, 256 QAM
<b>Frequency Range</b>	5 to 85 MHz
<b>Amplitude</b>	<b>CW:</b> Adjustable from 10 to 40 dBmV <b>16/32/64/128/256 QAM:</b> Fixed 30 dBmV
<b>QAM Symbol Rates</b>	0.64, 1.28, 2.56, 5.12 MSPS
<b>QAM Source Error Rates</b>	<b>BER:</b> Adjustable from 0 to 1.00E-2 <b>MER:</b> > 38 dB
<b>CW Source Accuracy</b>	±2 dB

## PHYSICAL & ENVIRONMENTAL SPECIFICATIONS

### Physical Specifications

<b>Construction</b>	Rubber overmolded plastic housing
<b>Control</b>	Glow in the dark keypad and LCD touch screen and/or via a wireless connection to a mobile device such as a laptop, tablet, iPad® or iPhone®, or Android® handset
<b>Display</b>	Color LCD touch screen 480 x 272 pixels (approx 4" x 2.25")
<b>Annunciators</b>	Audible annunciator for key strokes
<b>Antenna</b>	Internal Wi-Fi antenna, 2 dB gain
<b>Flashlight</b>	High intensity LED (0.25W)
<b>Dimensions w/o Case (H x W x D)</b>	8.0 x 5.5 x 2.75 in (20.32 x 13.97 x 6.99 cm)
<b>Dimensions w/ Case (H x W x D)</b>	9.0 x 6.5 x 3.75 in (22.86 x 16.51 x 9.53 cm)
<b>Weight w/o Case</b>	2.75 lbs (1.25 Kg)
<b>Weight w/ Case</b>	3.75 lbs (1.70 Kg)

### Available Interface Types

<b>RF Test Port</b>	Replaceable F-Type connector DOCSIS 3.0 Modem (8x4)
<b>Ethernet</b>	RJ45 Management Port (10/100 Mbps) RJ45 Electrical Test Port (10/100/1000Base-T) SFP Optical Test Port (100/1000Base-X)
<b>Wi-Fi</b>	802.11 b/g/n 2.4/5 GHz Wi-Fi Adapter
<b>USB</b>	USB 2.0 Type-A Standard Port
<b>Bluetooth (Optional)</b>	Class II Mini Bluetooth USB Adapter (v2.1) with a 10 meter range for speeds up to 3 Mbps

### Battery & Power Specifications

<b>Operating Time</b>	8 to 10 hours, dependent on use
<b>Charge Time</b>	4 hours
<b>Battery</b>	Two 2600 mAh @ 7.4V Li-Ion internal batteries, factory replaceable
<b>Power Adapter</b>	<b>Input:</b> 100 to 240 VAC ~ 47 to 63 Hz, 1.1A Max <b>Output:</b> 15 VDC, 3.3A

### Environmental Specifications

<b>Storage &amp; Operating Temperature</b>	-18° to +50° C (0° to 122° F)
--	-------------------------------

## INCLUDES THE FOLLOWING:

720 DSP Meter  
 Protective Carrying Case  
 Shoulder Strap  
 AC to DC Power Adapter & Battery Charger  
 US AC Power Cable (US Models)  
 Euro AC Power Cable (Euro Models)  
 Touchscreen Stylus

## SOFTWARE:

ViewPoint Express Configuration Software for the 720 DSP  
**P/N 0930215000**  
 ViewPoint Integrated Server with WFM Module for the 720 DSP  
**P/N 2011656002**  
 ACTS™ Software  
**P/N 0930144000**

## RELATED PRODUCTS:

Precision Test Cable (I/O-15)  
**P/N 2071527048**  
 I-Stop 1 GHz Test Probe  
**P/N 2010838002**  
 TLB-46 Return Measurement Low-Pass Filter  
**P/N 2011640000**