

DISCONTINUED

Yokogawa AQ1200A Specs  
Provided by www.AAATesters.com

YOKOGAWA 

# AQ1200 MFT-OTDR

MULTI FIELD TESTER OTDR

All-in-One  
handheld optical fiber network test tool



Seven models offer different wavelength  
and dynamic range combinations

QUALITY ■ INNOVATION ■ FORESIGHT

[www.tmi.yokogawa.com](http://www.tmi.yokogawa.com)  
Test & Measurement Instruments

Bulletin AQ1200-13EN

# Multifunctional Handheld OTDR

## Offering Powerful Test Features & Excellent

### Compact chassis yet fully equipped with field testing functions

The AQ1200 Multi Field Tester OTDR is a compact and lightweight handheld OTDR optimized for the installation and maintenance of optical fiber cables. Designed with ease of use in mind to simplify field testing, improve work efficiency and ensure quality results. Seven models are offered, each with unique wavelength(s) based on their specific application.

**Visible Light Source\***  
For visually identifying fiber under test and locating a break point within the near-end dead zone.

**DC power connector**

**USB TYPE A**

**[Top view]**

**Optical power meter port\*\***  
Optical power meter and a continuous wave optical output function which can work independently. The optical power meter can be chosen from three types in accordance with your application.

**OTDR, Light source\*\***

**[Bottom view]**

**USB TYPE B (mini USB)**  
OTDR can be controlled with a PC via USB.

**LAN\***  
OTDR can be controlled with a PC via Ethernet network. Test network connections sending PING without a PC.

Wave length:  
Port2 : 1310/1550(AQ1200A/E, AQ1205A/E/F)  
1625nm\*\*(AQ1200B), 1650nm\*\*(AQ1200C)  
Port3 : 1625nm\*\*(AQ1200E), 1650nm\*\*(AQ1205F)

**[Front view]**

**Soft keys**  
To select the menu on the right side of the display.

**Bumper**  
Shock protection

**Hand belt**  
To hold with one hand during operation and also serves as a convenient carrying handle

**MENU key**  
Moves to main menu

**REAL TIME and AVG key**  
To start or stop the OTDR measurement (Real-time and Averaging)

**Rotary Knob**  
To move the cursor and change parameters. Press to select parameters.

**Arrow keys/Enter keys**  
To move cursor and change parameters within a dialogue box.

**SETUP key**  
To show the setup menu.

**Power key**  
Power ON/OFF

**ESC key**  
To abort operations or escape from menus

**LCD display** 5.7inch TFT LCD display

\*: Option  
\*\*: Built-in Filter

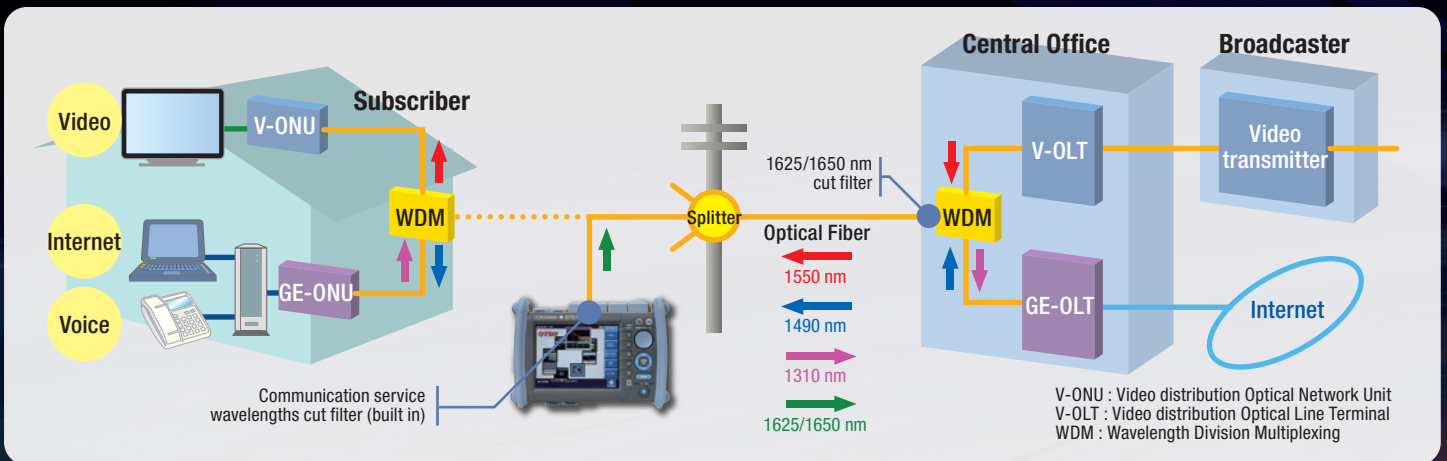

## Product Lineup

<b>AQ1200A</b>	<b>1310/1550 nm</b>	Standard model with the same wavelengths used for communication services. Applicable for installation and maintenance
<b>AQ1200B</b>	<b>1625 nm</b>	Models with a wavelength dedicated for maintenance of live fibers. A built-in cut filter isolates the maintenance wavelength from the communication wavelength in order to perform accurate measurements in live networks.
<b>AQ1200C</b>	<b>1650 nm</b>	
<b>AQ1200E</b>	<b>1310/1550 nm 1625 nm</b>	
<b>AQ1205A</b>	<b>1310/1550 nm</b>	This High dynamic range model can accurately measure the trace even after the splitter in a PON system. Thus this standard wavelength model is highly suited for high port count PON networks with up to 64 ports splitters.
<b>AQ1205E</b>	<b>1310/1550 nm 1625 nm</b>	These tri-wavelength models offers high dynamic range and has two ports. One port offers the communication wavelengths while the other port is dedicated for the maintenance wavelength. Thus this model is ideal for use in both installation and maintenance applications.
<b>AQ1205F</b>	<b>1310/1550 nm 1650 nm</b>	

\* : Please make sure that the measurement signal does not affect the communication services before use, by implementing a measurement wavelength cut filter in the line under test or otherwise.

## PON Measurement Capability

In Passive Optical Network (PON) System used in FTTH (Fiber To The Home) it is important to quickly and correctly find a fault in the drop cable that is installed after the splitter.

The AQ1200 MFT OTDR's PON measurement mode (\*) is a mode optimized for the measurement of PON with a high-port-count optical splitter and can ensure a quality waveform even if there is a big loss of optical splitter in the line.

With a short dead zone, the AQ1200 can distinguish connectors placed as closely as 0.75 m in FTTH, home or office networks.

### • Example of measurement over a 64 port splitter

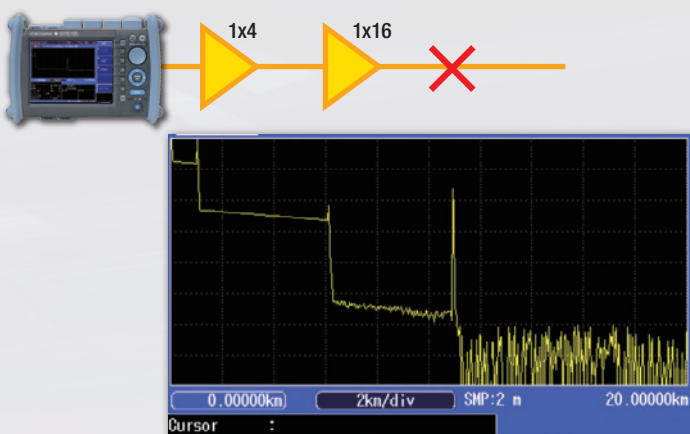

### • Event dead zone 0.75 m

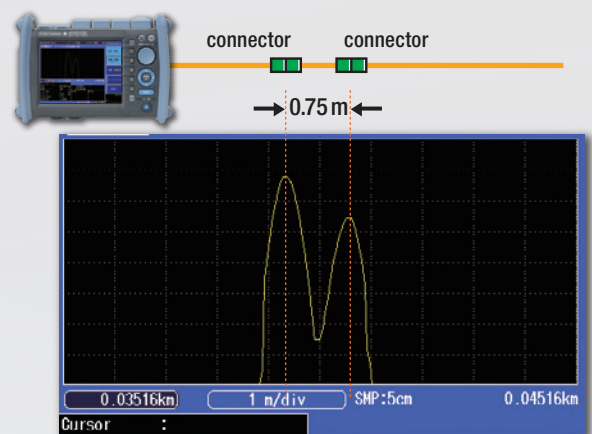

## Fault locator

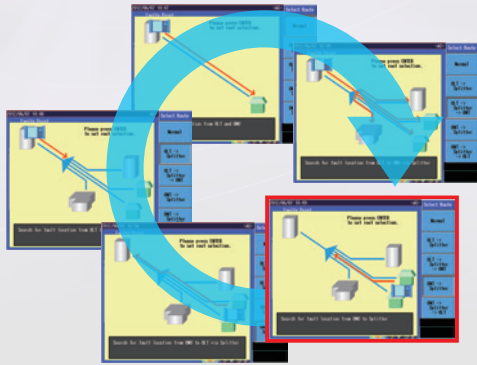

Select the Structure

### Find a fiber break point easily and rapidly

Pressing one button initiates a measurement and event search and then clearly indicates the location of a fiber break.

Waveform analysis can be done by simply switching over to OTDR function.

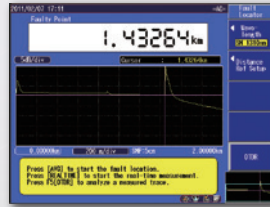

Fault locator screen

In-depth waveform analysis

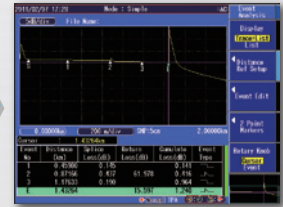

Waveform analysis screen of OTDR function

## Light Source & Optical Powermeter

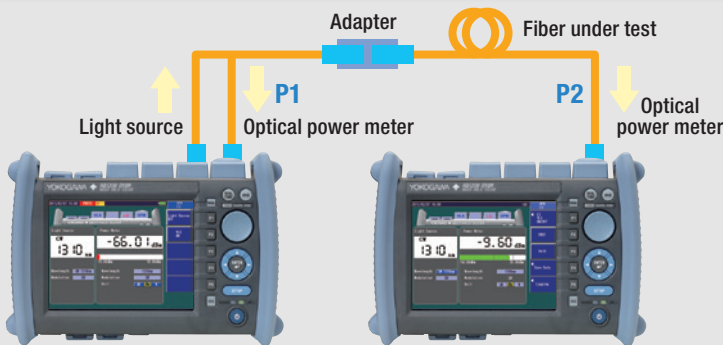

### Manual Loss test using light source & optical powermeter\*1,\*2

After adjusting the optical output power (P1) at the end of launch fiber, measure the output power of fiber under test (P2).

**Total fiber loss = P1 - P2 (dB)**

### High power measurement\*2

Allow to measure the high power output of optical amplifier, which is used for video services, such as CATV, and long distance transmission.

\*1 : /SLT option is required to use this function. \*2 : /HLT option is required to use this function.

## Auto Loss Test\*

### Loss measurement with LS & OPM interlock

AQ1200's light source can transmit wavelength information, so that AQ1200's optical powermeter can make measurements at a right wavelength at the other end. Moreover, the AQ1200A's light source and optical powermeter can switch between two wavelengths (1310 and 1550 nm) automatically; therefore, the optical powermeter can make measurements at right wavelengths, changing the wavelength along with the light source.

### Measurement result storage and report output

Measurement results can be saved in the internal storage or external USB storage media, and the measurement report can be generated in CSV format.

\* : /SLT or /HLT option is required to use this function.

## Multicore Loss Test\*

### Work as Master & Slave using the communication fiber

The master unit can share the project information such as the core number table and measurement conditions with the slave unit by sending them through the communication fiber in the cable under test.

\* : /SLT or /HLT option is required to use this function.

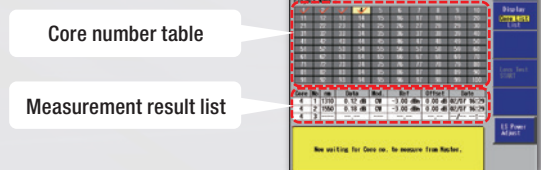

Multicore measurement result screen

## PON Optical Powermeter\*

### Simultaneous 1490 & 1550 nm measurement

The PON power meter can measure the optical power both at 1490 nm and at 1550 nm simultaneously by separating those wavelengths.

Suitable tool for measuring the optical power of OLT and V-OLT.

\* : /PPM option is required to use this function.

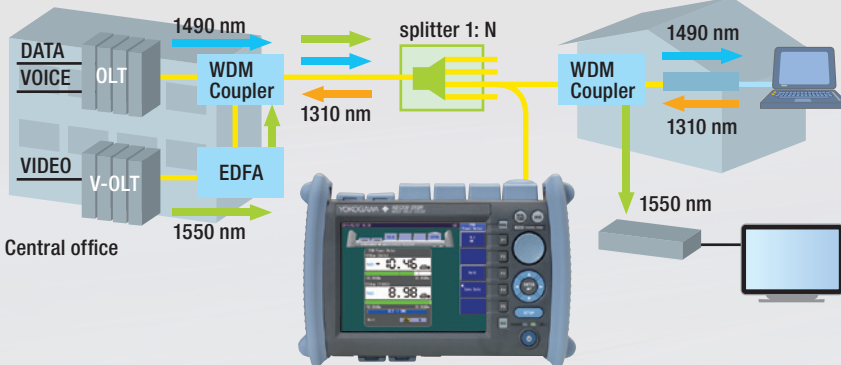

Optical power at 1490 nm

Optical power at 1550 nm



PON optical powermeter screen

## Trace Analysis Functions

### For Evaluation of Multicore Fiber

#### — Multi Trace Analysis

Up to four traces can be overlaid on the display for analysis and comparison.

This is useful for evaluating connection point locations and loss after installing multicore fiber.

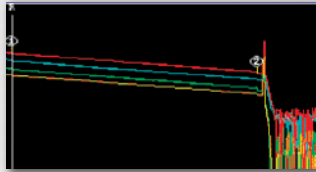

### For Evaluation of Aged Deterioration

#### — Differential Trace Analysis

Displays the difference between two specified traces.

Makes it simple to check aged deterioration of fibers or connection points, or fluctuation in loss between fibers, and other phenomena.

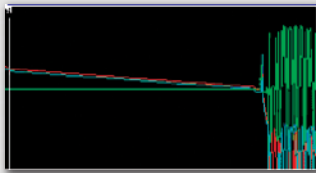

### For Accurate Splice Loss Measurement by Bi-directional Testing

#### — 2 Way Trace Analysis

Merges the two traces measured from both directions and finds the correct splice loss.

Connection loss in lines where optical fibers of differing backscatter coefficients are connected can differ depending on the direction. In such cases, you can accurately determine the loss by measuring in both directions and taking an average.

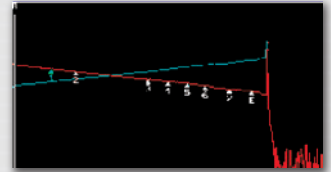

### For Evaluation of Total Return Loss

#### — Section Analysis

Finds the total return loss in specific portions of the fiber.

This type of evaluation is often requested because the multiple reflections from optical fiber networks can affect signal light from transmitters (cable TV etc.).

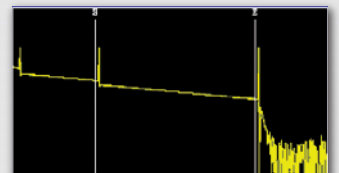

## Visible Light Source\*

### Visual fault location and Fiber identification

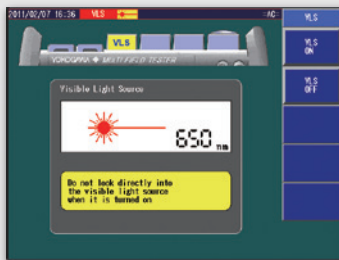

Visible light source screen

The visible light source enables to identify a single core out of multicore fiber and find a break point in a launch area visually. This feature works even when OTDR is in use, so that you can search for a next fiber to test, while OTDR is measuring one fiber.

\*: /VLS option is required to use this function.

## Multi Fiber Measurement Function

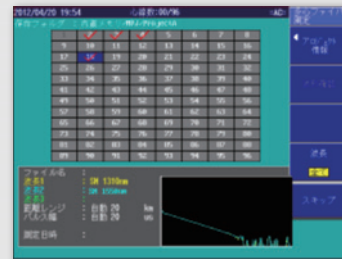

The Multi fiber measurement function automatically performs measurements and data-filing according to a pre-established file name table.

At worksite, you can execute it by simply selecting a fiber number in the table.

The saved waveform can be easily shown in the preview

window by selecting the core number in the table.

The OTDR Project File Editor included in AQ7932 Emulation Software greatly saves time to create file name table.

## Macro Bending Function (not available for the AQ1200B, AQ1200C)

If there is a bend in the optical fiber, the long wavelength loss is higher at the location of the bend. This function uses this characteristic to locate macro bends by measuring the same line at multiple wavelengths.



## Remote Control Software

### Remote Control using the same GUI

The AQ1200 can be remotely controlled from a personal computer (PC) through Ethernet\* or USB interface.

The remote control software displays a front panel image of AQ1200 on PC, so you can control the AQ1200 with mouse in the same manner as operating the actual instrument.

\*: /LAN option is required to use this function.

## Video Fiber Inspection Probe



Fiber Inspection Probe screen

### Fiber end inspection

With a video fiber inspection probe connected to USB interface, the AQ1200 can show an image of the fiber end on the screen to visually inspect scratches and dirtiness. The video image can be saved in the internal memory or external USB storage media.

\*: Recommended probe: DI-1000-B2 (Lightel)

## IP Test\*



PING Test screen

### IPv4 PING

For testing network connections by sending PING through the optional LAN interface, no need to bring a PC.

Variable frame length and transmission intervals

\*: /LAN option is required to use this function.

## Data Analysis and Report Creation Tool

### • AQ7932 OTDR Emulation Software (Sold Separately)

The AQ7932 is an application software that performs analysis of trace data measured by the AQ1200 MFT-OTDR and creates reports on a PC. The report creation wizard function makes this task simple. AQ1200 MFT-OTDR data can be easily loaded onto a PC using USB memory or storage function.

(The AQ1200 MFT-OTDR is supported from software version 4.1. Please make sure of the version information before use.)

#### ■ Trace Analysis

You can edit event search conditions, approximate curve line secngs, and other analysis conditions, and repeat the analysis. Operation is also easy. Simply click the function icon.

#### ■ Variety of Analysis Functions

Display up to eight traces on screen, and perform a variety of analyses including multi trace analysis and differential trace analysis for comparing recent waveforms with old ones, and use the 2 way trace analysis function for analyzing average values of data measured from both ends of optical fiber.

#### ■ Creating Reports

You can compile traces and measured values of trace files and creates a report. Reports can be created easily by just following the step-by-step instructions in the report wizard and saved in Excel or CSV format.

#### • Functionality

Data format: .SOR (Bellcore), .SOR (Telcordia [AQ1200/AQ7275/AQ7270/AQ7260]), TRD(AQ7260), .TRB(AQ7250), .BMP(BMP), .CSV (Data CSV), .CSV (Event List CSV)

Report output: CSV file, XLS file, and print out

#### • PC requirements (Software and Hardware)

##### Software

OS: Microsoft Windows 2000, Microsoft Windows XP, Microsoft Windows Vista\*, Windows 7

Excel: Microsoft Excel 2000 or later (when the XLS file output function is used)

##### Hardware

Clock speed: Environment in which the OS operates smoothly.

HD capacity: 20 MB or more space required at the time of installation

Memory capacity: 128 MB or more (256 MB or more recommended)

Display: Resolution of 1024 × 768 pixels or better

Disc drive: CD-ROM drive

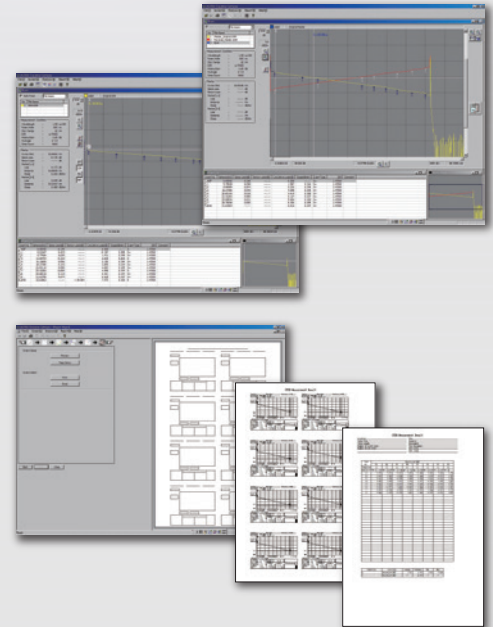

Microsoft Windows 2000, Windows XP, Windows Vista and Windows 7 are registered trademarks or trademarks of Microsoft Corporation in the United States and other countries. The TM and © symbols are not used to indicate registered trademarks and trademarks in this document. (\*) Microsoft Windows Vista is to be supported in Ver. 3.03 and later.

## Comon Specifications

### Horizontal Axis Parameters

Sampling resolution	5 cm, 10 cm, 20 cm, 50 cm, 1 m, 2 m, 4 m, 8 m, 16 m, 32 m
Readout resolution	1 cm (Min.)
Number of sampled data	Up to 128,000 points (Firmware Rev2.01 or later)
Group refractive index	1.30000 to 1.79999 (in 0.00001 steps)
Unit of distance	km, kf or miles
Distance measurement accuracy	$\pm 1 \text{ m} + \text{Measurement distance} \times 2 \times 10^{-5} \pm$ sampling resolution Excluding IOR uncertainty

### Vertical Axis Parameters

Vertical axis scale	0.2 dB/div, 0.5 dB/div, 1 dB/div, 2 dB/div, 5 dB/div, 7.5 dB/div
Readout resolution	0.001 dB (Min.)
Loss measurement accuracy	$\pm 0.05 \text{ dB/dB}$ (When the measuring loss is 1 dB or less, the accuracy is within $\pm 0.05 \text{ dB}$ .)

### OTDR Measurement Function

Distance measurement	Displays up to eight digits of the relative one way direction between two arbitrary points on the trace.
Loss measurement	Displays one way loss in steps of 0.001 dB to a maximum of 5 digits. Displays the one way loss, loss per unit length, and splice loss between any arbitrary points on the trace.
Return loss measurement	Measures return loss and total return loss of a fiber cable or between two arbitrary points on the trace.

### OTDR Analysis Functions

Analysis functions	Section analysis
--------------------	------------------

### Internal Memory

Memory capacity	1000 waveforms or more Can store measured waveforms and measurement conditions
-----------------	---

### Display

Display	5.7 inch color TFT LCD
Total number of displayed pixels*	640 (horizontal) × 480 (vertical) pixels

\*: The LCD may contain some pixels that are always ON or OFF (0.002% or fewer of all displayed pixels including RGB), but this is not indicative of a general malfunction.

### External Interface

USB	USB1.1 Type A and Type B, one each Type A: For external memory, external printer, and fiber inspection probe Type B (mini): For connecting to an external PC for remote control or access to the OTDR's internal memory.
-----	--

### File Formats

File formats	Read: SOR, SET (AQ7270/AQ7275/AQ1200) Write: SOR (Telcordia), SET, CSV, BMP, JPG, PNG
--------------	--

## Specifications per Model

Model name	AQ1200A	AQ1200B <sup>*1</sup>	AQ1200C <sup>*1</sup>	AQ1200E <sup>*1</sup>	AQ1205A	AQ1205E <sup>*1</sup>	AQ1205F <sup>*1</sup>
Measured wavelength (nm)	1310±20(typ) <sup>*2</sup> / 1550±20(typ) <sup>*2</sup>	1625±10	1650±5 <sup>*3</sup> , 1650±10 <sup>*4</sup>	1310±20(typ) <sup>*2</sup> / 1550±20(typ) <sup>*2</sup> , 1625±10	1310±20(typ) <sup>*2</sup> / 1550±20(typ) <sup>*2</sup>	1310±20(typ) <sup>*2</sup> / 1550±20(typ) <sup>*2</sup> , 1625±20(typ)	1310±20(typ) <sup>*2</sup> / 1550±20(typ) <sup>*2</sup> , 1650±5 <sup>*3</sup> , 1650±10 <sup>*4</sup>
Optical Port	PORT2			PORT2, 3	PORT2	PORT2, 3	
Measured fiber	SM(ITU-T G.652)						
Distance range(km)	0.5, 1, 2, 5, 10, 20, 50, 100, 200, 300, 400, 512 <sup>*11</sup>			0.5, 1, 2, 5, 10, 20, 50, 100, 200, 300, 400, 512			
Pulse width(ns)	3, 10, 20, 50, 100, 200, 500, 1000, 2000, 5000, 10000, 20000 <sup>*11</sup>			3, 10, 20, 50, 100, 200, 500, 1000, 2000, 5000, 10000, 20000			
Event Dead zone (typ.) <sup>*7</sup>	0.75m <sup>*8</sup>						
Attenuation Dead zone (typ.) <sup>*9</sup>	4m/5m	7m		4m/5m, 7m	4m/5m	4m/5m, 7m	
Dynamic range(dB) (typ.)	34/32 <sup>*5</sup>	33 <sup>*5</sup>	34 <sup>*5</sup>	38/36, 36 <sup>*5</sup>	42/40 <sup>*6</sup>	42/40, 38 <sup>*6</sup>	42/40, 37 <sup>*6</sup>
Loss measurement accuracy	±0.05dB or ±0.05dB/dB						
Optical connector	Universal Adapter SC, FC						
Output power control <sup>*10</sup>	---	Normal / Low			---	Normal / Low	
Laser safety standard	Class 1 or Class 1M						

\*1 : Pulse light output poert at 1625 nm and 1650 nm, +15 dB or less, built-in 1310 & 1550 nm cut filter.

\*2 : 25 nm is guaranteed

\*3 : At a point -20 dB from the pulse light output peakvalue (measured after 30 minutes or more form power-on at an ambient temperature of 23°C)

\*4 : At a point -60 dB from the pulse light output peakvalue (measured after 30 minutes or more form power-on at an ambient temperature of 23°C)

\*5 : SNR=1, Pulse width: 10 µs, measurement time: 3 minutes, When angled -PC connectors are used, each dynamic range decreases by 0.5 dB, Guaranty value [dB]; 32/30 (AQ1200A), 30 (AQ1200B), 30 (AQ1200C), 32/30, 30 (AQ1200E)

\*6 : SNR=1, Pulse width: 20 µs, measurement time: 3 minutes, When angled -PC connectors are used, each dynamic range decreases by 0.5 dB, Guaranty value [dB]; 40/38 (AQ1205A), 40/38, 36 (AQ1205E), 40/38, 30 (AQ1205F)

\*7 : Pulse width 3 ns, return loss: 55 dB or more

\*8 : 0.8 m is guaranteed

\*9 : Pulse width 10 ns, Return loss 55 dB or more, at a point where the backscatter level is within ±0.5 dB of the normal value.

\*10 : At 1625 nm and 1650 nm

\*11 : FirmWare Rev2.01 or later

Note : Specifications are at 23°C ±2°C unless otherwise noted.

## Specifications per Option

### • Light source & Optical powermeter option

Option		Optical Power Meter (/SPM)	Standard (/SLT)	High Power (/HLT)	PON (/PPM)	Stabilized Light Source (/SLS)	
Optical Power meter	Wavelength setting	850/1300/1310/1490/1550/1625/1650 nm or 800 to 1700 nm (1 nm steps) or CWDM wavelength (1270 to 1610 nm, 20 nm step)			1310/1490/1550 nm	---	
	Applicable fiber	SM (ITU-T G 652), GI (50/125 µm)			SM (ITU-T G 652)	---	
	Power range	CW	+10 to -70 dBm		+27 to -50 dBm <sup>*3</sup>	+10 to -70 dBm <sup>*1</sup> , +27 to -50 dBm <sup>*2</sup>	---
		CHOP	+7 to -60 dBm		+24 to -50 dBm <sup>*3</sup>	---	---
	Noise level	0.5 nW (-63 dBm, 1310 nm)		50 nW (-43 dBm, 1310 nm)	0.5 nW (-63 dBm, 1310 nm), 50 nW (-43 dBm, 1550 nm)	---	
	Uncertainty under standard conditions <sup>*4</sup>	±5%			±0.5 dB		---
	Readout resolution	0.01					---
	Level unit	Absolute: dBm, mW, µW, nW Relative: dB					---
	Modulation mode	CW, CHOP (270 Hz/1 kHz/2 kHz)					---
Average function	1, 10, 50 and 100 times					---	
Light source	Wavelength	---	1310/1550 ±0.25 nm (AQ1200A/E, AQ1205A/E/F), 1625 ±10 nm (AO1200B/E), 1625 ±25 nm (AO1205E), 1650 ±5 nm <sup>*5</sup> , 1650 ±10 nm <sup>*6</sup> (AQ1200C, AQ1205F)			---	
	Optical output level	---	-3 dBm ±1 dB			---	
	Level stability <sup>*7</sup>	---	±0.05 dB (1310/1550 nm, AQ1200A/E, AQ1205A/E/F), ±0.15 dB (1625/1650 nm, AQ1200B/C/E, AQ1205E/F)			---	
	Modulation mode	---	CW, 270 Hz, 1 kHz, 2 kHz			---	
Applicable fiber	---	SM (ITU-T G.652)					
Memory and logging function	---	Measurement data storage: 10 to 1000 data, Logging interval: 0.5, 1, 2, 5, or 10 sec.					
Auto loss test function	---	Loss measurement with light source and optical powermeter interlock			---	---	

\*1 : at 1310/1490 nm \*2 : at 1550 nm \*3 : 1300 to 1600 nm

\*4 : Power level: 100 µW(-10dBm); CW, Wavelength: 1310 ±20 nm (1550 nm ±10 nm for 1550 nm setting of /PPM), Spectral width: 10 nm or less (1310 nm), ambient temperature: 23 ±2°C, Optical fiber: SM (ITU-T G.652), Optical connector: FC/PC, Wavelength setting error: 0.5 nm or less, excluding aging (add 1% one year after calibration)

\*5 : At a point -20 dB from the pulse light output peak value (measured after 30 minutes or more from power-on, at ambient temperature of 23°C)

\*6 : At a point -60 dB from the pulse light output peak value (measured after 30 minutes or more from power-on, at ambient temperature of 23°C)

\*7 : Constant temperature within 23°C ±2°C ; CW (15 min.)

### • Visible light source (VLS) option

Optical connector	2.5 mm ferrule type
Center wavelength	650 nm ±20 nm
Optical output level	-3 dBm or more (peak)
Modulation mode	CHOP Approx. 2 Hz
Laser class	3R



### • Ethernet interface option

Interface	10BASE T / 100BASE TX
Functions	PING test, PC remote control

## General Specifications

Item	Specification	
Environmental conditions	Storage temperature	-20 to 60°C
	Operating temperature	0 to 45°C (0 to 40°C when AC adapter is being used); (0 to 35°C when battery is being charged)
	Humidity	20 to 85% RH (no condensation)
Power requirements	100 to 240 VAC, 50/60 Hz	
Battery pack	Run time: 6 hours*1, Recharge time: 5 hours*2	
Dimensions	217.5 (W) × 157 (H) × 74 (D) mm, excluding projections	
Mass	Approx. 1 kg, including battery pack	
Compliant standards	Laser safety	EN 60825-1:2014 Class 1 <sup>3</sup> , Class 1M (IEC60825-1:2007, GB7247.1-2012) <sup>4</sup> , 21CFR1040.10 <sup>5</sup>
	Safety	EN61010-1
	Emissions	EN61326-1 class A, EN55011 class A, group 1
	Immunity	EN61326-1 Table 2 (for industrial locations)

\*1 : In case measurement is performed for 30 seconds every 3 minutes, with no options installed, in power save mode (LCD brightness: Power save, Screen saving: ON).

\*2 : at temperature of 23°C, power OFF



\*5 : Complies with 21 CFR 1040.10 and 1040.11 except for deviations pursuant to Laser Notice No.50, dated June 24, 2007  
2-9-32 Nakacho, Musashino-shi, Tokyo 180-8750, Japan  
21CFR1040.10

## Model and suffix code

Models	Suffix code	Descriptions
AQ1200A		1310/1550 nm
AQ1200B		1625 nm
AQ1200C		1650 nm
AQ1200E		1310/1550, 1625 nm
AQ1205A		1310/1550 nm, High Dynamic Range
AQ1205E		1310/1550, 1625 nm High Dynamic Range
AQ1205F		1310/1550 nm High Dynamic Range, 1650 nm
Language	-HE	English
	-HC	Chinese/English
	-HM	Chinese
	-HK	Korean/English
	-HR	Russian/English
Power cord	-D	UL/ CSA standard, 125 V
	-F	VDE standard, 250 V
	-R	Australian standard, 250 V
	-Q	BS/Singaporean standard, 250 V
	-H	Chinese standard, 250 V
	-P	Korean standard, 250 V
	-T	Taiwanese standard, 125 V
-N	Brazilian standard, 250 V	
Optical connector	-USC	SC type
	-UFC	FC type
	-ASC	SC/Angled-PC type
light source & optical power meter	/SLT	Stabilized light source & Standard optical power meter
	/HLT	Stabilized light Source & High power optical power meter
	/PPM	Light source & PON Power meter
	/SLS	Stabilized light source
	/SPM	Standard optical power meter
Visible light source	/VLS	Optical connector: 2.5φ ferrule
PON measurement*1	/PN	PON measurement mode
Ethernet	/LAN	10BASE-T/100BASE-TX (PING test, Remote control)
Shoulder belt	/SB	Shoulder belt

\*1 : Only for AQ1200A, AQ1200B/C/E and AQ1205A/E/F come equipped this function.  
The mode is optimized for PON measurement.

## Accessories (optional)

Model	Suffix code	Descriptions
SU2006A		Soft carrying case
735480 (For optical powermeters)	-SCC	Connector adapter (SC)
	-FCC	Connector adapter (FC)
735481 (For optical powermeters)	-LMC	Ferrule adapter (φ1.25)*1
	-SFC	Ferrule adapter (φ2.5)*1
SU2005A (For OTDR, LS and PON Power meter)	-SCC	Universal adapter (SC)
	-FCC	Universal adapter (FC)
739874 (AC adapter)	-D	UL/CSA standard, 125 V
	-F	VDE standard, 250 V
	-R	Australian standard, 250 V
	-Q	BS/Singaporean standard, 250 V
	-H	Chinese standard, 250 V
	-P	Korean standard, 250 V
	-T	Taiwanese standard, 125 V
739882		Battery pack (Spare)
B8070CY		Shoulder belt

\*1 : The ferrule adapter has no mechanism to lock the connected fiber.  
Please be cautious of the connection, especially when emitting high power light.

## Dimensions

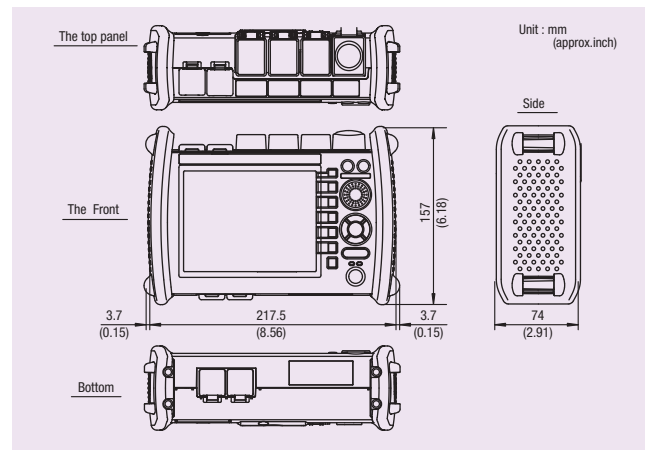

## Application Software

Model	Suffix code	Descriptions
735070-	-EN	AQ7932 OTDR Emulation Software (Ver. 4.1 or later) Display English

### Yokogawa's Approach to Preserving the Global Environment

- Yokogawa's electrical products are developed and produced in facilities that have received ISO14001 approval.
- In order to protect the global environment, Yokogawa's electrical products are designed in accordance with Yokogawa's Environmentally Friendly Product Design Guidelines and Product Design Assessment Criteria.

### NOTICE

- Before operating the product, read the user's manual thoroughly for proper and safe operation.
- If this product is for use with a system requiring safeguards that directly involve personnel safety, please contact the Yokogawa sales offices.

# YOKOGAWA

YOKOGAWA TEST & MEASUREMENT CORPORATION

Global Sales Dept. /Phone: +81-422-52-6237 E-mail: tm@cs.jp.yokogawa.com  
Facsimile: +81-422-52-6462

YOKOGAWA CORPORATION OF AMERICA

YOKOGAWA EUROPE B.V.

YOKOGAWA TEST & MEASUREMENT (SHANGHAI) CO., LTD.

YOKOGAWA ELECTRIC KOREA CO., LTD.

YOKOGAWA ENGINEERING ASIA PTE. LTD.

YOKOGAWA INDIA LTD.

YOKOGAWA ELECTRIC CIS LTD.

YOKOGAWA AMERICA DO SUL LTDA.

YOKOGAWA MIDDLE EAST & AFRICA B.S.C(c)

Phone: +1-800-888-6400

Phone: +31-88-4641429

Phone: +86-21-6239-6363

Phone: +82-2-2628-3810

Phone: +65-6241-9933

Phone: +91-80-4158-6396

Phone: +7-495-737-78-68

Phone: +55-11-3513-1300

Phone: +973-17-358100

E-mail: tmi@us.yokogawa.com

E-mail: tmi@nl.yokogawa.com

E-mail: tmi@cs.cn.yokogawa.com

E-mail: TMI@kr.yokogawa.com

E-mail: TMI@sg.yokogawa.com

E-mail: tmi@in.yokogawa.com

E-mail: info@ru.yokogawa.com

E-mail: tm@br.yokogawa.com

E-mail: help.ymatmi@bh.yokogawa.com

Printed in Japan, 906(KP)

Facsimile: +86-21-6880-4987

Facsimile: +82-2-2628-3899

Facsimile: +65-6241-9919

Facsimile: +91-80-2852-1442

Facsimile: +7-495-737-78-69

Facsimile: +973-17-336100

<https://tmi.yokogawa.com/>

YMI-KS-HMI-SE07

The contents in this catalog is as of June 2019. Subject to change without notice.

Copyright © 2010, Yokogawa Electric Corporation

Copyright © 2010, Yokogawa Test & Measurement Corporation

[Ed: 04/b]