

## Instruction Bulletin

## Universal Test Set

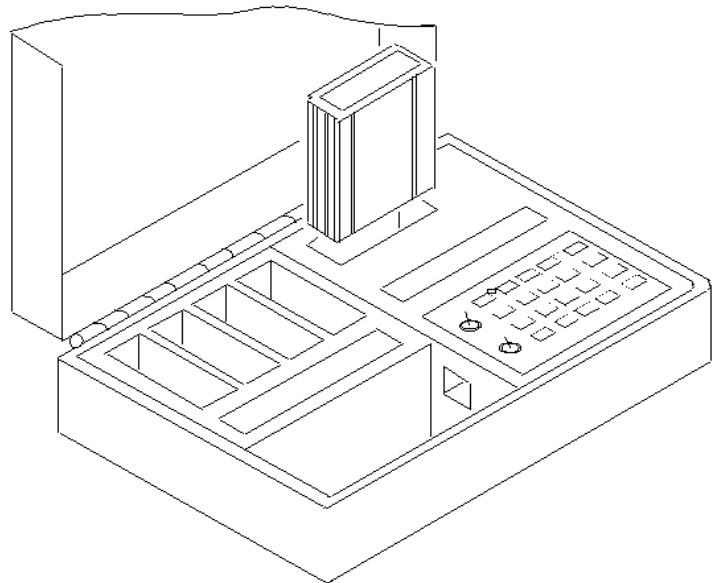

## NOTICE

Read these instructions carefully and look at the equipment to become familiar with the device before trying to install, operate, service or maintain it. The following special messages may appear throughout this bulletin or on the equipment to warn of potential hazards or to call attention to information that clarifies or simplifies a procedure.



The addition of either symbol to a “Danger” or “Warning” safety label indicates that an electrical hazard exists which will result in personal injury if the instructions are not followed.



This is the safety alert symbol. It is used to alert you to potential personal injury hazards. Obey all safety messages that follow this symbol to avoid possible injury or death.

<b>⚠ DANGER</b>
<b>DANGER</b> indicates an imminently hazardous situation which, if not avoided, <b>will result in</b> death or serious injury.

<b>⚠ WARNING</b>
<b>WARNING</b> indicates a potentially hazardous situation which, if not avoided, <b>can result in</b> death or serious injury.

<b>⚠ CAUTION</b>
<b>CAUTION</b> indicates a potentially hazardous situation which, if not avoided, <b>can result in</b> minor or moderate injury.

<b>CAUTION</b>
<b>CAUTION</b> , used without the safety alert symbol, indicates a potentially hazardous situation which, if not avoided, <b>can result in</b> property damage.

*NOTE: Provides additional information to clarify or simplify a procedure.*

**PLEASE NOTE:**

Electrical equipment should be installed, operated, serviced and maintained by qualified electrical personnel. This document is not intended as an instruction manual for untrained persons.

**FCC NOTICE:**

This equipment has been tested and found to comply with the limits for a Class A digital device, pursuant to part 15 of the FCC Rules. These limits are designed to provide reasonable protection against harmful interference when the equipment is operated in a commercial environment. This equipment generates, uses, and can radiate radio frequency energy and, if not installed and used in accordance with the instruction manual, may cause harmful interference to radio communications. Operation of this equipment in a residential area is likely to cause harmful interference in which case the user will be required to correct the interference at his own expense.

## Table of Contents

Section 1—General Information .....	4
Applications.....	4
Terminology .....	5
Test Types .....	5
Zone Interlocks and Self-Restraint.....	6
POWERLOGIC System .....	7
Section 2—Self-Test .....	8
Section 3—Test Circuit Breaker .....	10
Section 4—MICROLOGIC Series B CBTMB Test Module .....	14
Test Setup.....	14
Test Setup for Full-function Circuit Breakers .....	15
Test Setup for Standard-function Circuit Breakers .....	16
Main Test Menu .....	17
Automatic Test Menu for all Circuit Breakers without Ground-fault Alarm.....	18
Automatic Test Menu for Circuit Breakers with Ground-fault Alarm.....	19
Individual Test Menu for All Full-function Circuit Breakers without Ground-fault Alarm .....	20
Individual Test Menu for Full-function Circuit Breakers with Ground-fault Alarm.....	22
Individual Test Menu for All Standard-function Circuit Breakers.....	24
Manual Test Menu For All Full-function Circuit Breakers without Ground-fault Alarm .....	26
Manual Test Menu for Full-function Circuit Breakers with Ground-fault Alarm.....	27
Manual Test Menu for All Standard-function Circuit Breakers .....	28
Section 5—M-N-P-S CBTM4A Test Module .....	29
Test Setup for Full-function Circuit Breakers .....	29
Test Setup for Standard-function Circuit Breakers .....	30
Main Test Menu .....	31
Automatic Test Menu for Full-function Circuit Breakers.....	32
Automatic Test Menu for Standard-function Circuit Breakers.....	33
Individual Test Menu for Full-function Circuit Breakers .....	34
Individual Test Menu for Standard-function Circuit Breakers.....	36
Manual Test Menu for Full-function Circuit Breakers.....	37
Manual Test Menu for Standard-function Circuit Breakers .....	38
Section 6—SE CBTM1 Test Module .....	39
Test Setup.....	39
Automatic Test Menu .....	40
Individual-function Test Menu .....	41
Manual Test Menu .....	44
Section 7—ME-NE-PE CBTM3 Test Module .....	45
Test Setup.....	45
Automatic Test Menu .....	46
Individual-function Test Menu .....	47
Manual Test Menu .....	51
Index .....	52

## Section 1—General Information

### APPLICATIONS

#### CAUTION

##### HAZARD OF EQUIPMENT DAMAGE

Before using the test set, do the self-test to insure proper test set operation. The self-test is described in Section 2 of this manual.

**Failure to follow this instruction can result in equipment damage.**

The Universal Test Set is designed to perform operational tests and diagnoses of Square D electronic trip circuit breakers, circuit breaker components and tripping functions. It does not check the primary current sensing capabilities of a circuit breaker.

Check the following table to find the appropriate test set/test module for the circuit breaker.

**Table 1: Test Set/Test Module**

Circuit Breaker	Circuit Breaker Series Number	Test Set	Test Module <sup>1</sup>
LE/LX	1B	CBTU1 or UTS3	CBTMB
ME	1 and 2	CBT78	Not Available - Primary Injection Testing Only
	3	CBTU1 or UTS3	CBTM3
	4 and 5	CBTU1 or UTS3	CBTM4 or CBTM4A
	5A	CBTU1 or UTS3	CBTM4A
	5B	CBTU1 or UTS3	CBTMB
MX	4 and 5	CBTU1 or UTS3	CBTM4 or CBTM4A
	5B	CBTU1 or UTS3	CBTMB
NE	1	CBTU1 or UTS3	CBTM3
	2 and 3	CBTU1 or UTS3	CBTM4 or CBTM4A
	3A	CBTU1 or UTS3	CBTM4A
	3B	CBTU1 or UTS3	CBTMB
NX	2 and 3	CBTU1 or UTS3	CBTM4 or CBTM4A
	3B	CBTU1 or UTS3	CBTMB
PE	1,2, and 3	CBT78	Not Available - Primary Injection Testing Only
	4	CBTU1 or UTS3	CBTM3
	5 and 6	CBTU1 or UTS3	CBTM4 or CBTM4A
	6A	CBTU1 or UTS3	CBTM4A
	6B	CBTU1 or UTS3	CBTMB
PX	5 and 6	CBTU1 or UTS3	CBTM4 or CBTM4A
	6B	CBTU1 or UTS3	CBTMB
SE	1	CBTSE1	Not Available - Primary Injection Testing Only
	2	CBTU1 or UTS3	CBTM1
	3	CBTU1 or UTS3	CBTM4 or CBTM4A
	3A	CBTU1 or UTS3	CBTM4A
	3B	CBTU1 or UTS3	CBTMB

<sup>1</sup> A kit including the umbilical cord and rating plug adapter is available for each test module. The umbilical cord and rating plug adapter connect the test set to the circuit breaker being tested. A power cord (Part No. 48005-115-01) and an umbilical cord (Part No. 48155-055-50) are also available as replacement parts.

## TERMINOLOGY

The following terms are used in diagnosing circuit breaker functions:

**LONG-TIME PICKUP.** The current at which the long-time delay timer starts.

**LONG-TIME AMPERE RATING.** The current carrying capacity or “handle rating” of the circuit breaker.

**LONG-TIME DELAY.** The time period that the long-time delay timer runs before initiating a trip signal, i.e., the length of time the circuit breaker will carry a sustained low-level overload before initiating a trip signal.

**SHORT-TIME PICKUP.** The current at which the short-time delay timer starts, i.e., the current at which the short-time function recognizes an overcurrent.

**SHORT-TIME DELAY.** The time period short-time delay timer runs before initiating trip signal, i.e., the short-time delay allows the circuit breaker to carry or withstand low-level or high-level short-circuit currents (up to the published withstand ratings) with intentional delay before tripping. There are two choices of short-time delay characteristics available:

1. **1.2t IN.** A delay characteristic which results in an inverse-time delay that most closely parallels time-current characteristics of fuses.

2. **1.2t OUT.** A delay characteristic which results in a constant delay that coordinates best with thermal-magnetic and electronic trip circuit breakers.

**GROUND-FAULT PICKUP.** The ground-fault current level at which ground-fault delay timer starts, i.e., the function which allows the user to set the level of ground-fault current at which the trip system begins timing.

**GROUND-FAULT DELAY.** The time period the ground-fault delay timer runs before initiating trip signal, i.e., the function which determines the time the circuit breaker will wait before initiating a trip signal. There are two choices of ground-fault delay characteristics available:

1. **1.2t IN.** A delay characteristic which results in an inverse-time delay that coordinates best with zero sequence ground-fault relays used in conjunction with thermal-magnetic circuit breakers and fusible switches.

2. **1.2t OUT.** A delay characteristic which results in a constant delay characteristic that coordinates best with electronic trip circuit breakers with the ground-fault option.

**GROUND-FAULT ALARM PICKUP.** The ground-fault current level at which the trip unit initiates a signal to indicate a ground-fault condition. The circuit breaker will not trip.

## TEST TYPES

The Universal Test Set provides three test options for each type of circuit breaker tested. These test types are: Automatic Test Mode, Individual-function Test Mode, and Manual Test Mode. The information which follows explains the requirements for and the results obtained by each test.

*NOTE: A small straight-blade screwdriver is required for testing circuit breakers.*

### Automatic Test Mode

**TEST REQUIREMENTS:** Circuit breaker, rating plug and trip unit information.

**TEST RESULTS:** Tests long-time, short-time, instantaneous and ground-fault functions simultaneously without pauses or prompts; displays the amount of time delay before initiating the trip signal. Specifies which function failed on a pass/fail basis.

**Individual-function Test Mode**

**TEST REQUIREMENTS:** Circuit breaker, rating plug and trip unit information. Selection of the specific function(s) to be tested. The Individual-function test mode is accessed from the automatic test mode.

**TEST RESULTS:** Displays and diagnoses functions one at a time; tests each trip unit switch function as well as the operation of the indicators. Tests calibration and tolerance to predetermined values.

**Manual Test Mode**

**TEST REQUIREMENTS:** Circuit breaker, rating plug and trip unit information. A phase or ground- fault current value must be manually entered.

**TEST RESULTS:** Monitors and displays the trip time of the selected current applied to the trip unit.

<b>CAUTION</b>
<b>HAZARD OF EQUIPMENT DAMAGE</b>
Before using the test set, do the self-test on the testing unit to insure proper test set operation. The self-test is described in Section 2 of this manual.
<b>Failure to follow this instruction can result in equipment damage.</b>

**ZONE INTERLOCKS AND SELF-RESTRAINT**

Some testing procedures require the zone interlocks or any self-restraint jumper wires to be disconnected. If the circuit breaker is wired for zone interlocking or is self-restrained by jumper wires, do the following:

**LE, ME, NE and PE Circuit Breakers**

Refer to table 2 and disconnect wires or jumpers from terminals 6 and 8 of the terminal block. Reconnect the wires when testing is complete.

**Table 2: Terminal Numbering**

Number	Terminal Name
5	
6	ST Restraint OUT
7	
8	GF Restraint OUT
9	

**SE Circuit Breakers**

Refer to table 3 and disconnect wires or jumpers from terminals 21 and 24 of the terminal block. Reconnect the wires when testing is complete.

**Table 3: Terminal Numbering**

Number	Terminal Name
19	
20	
21	Ground-fault Zone Interlock
22	
23	
24	Short-time Zone Interlock
25	

## POWERLOGIC SYSTEM

If circuit breaker is connected to a POWERLOGIC® system, disconnect POWERLOGIC system before testing. If POWERLOGIC system is not disconnected, Universal Test Set will show “TEST FAILED” message.

Disconnect POWERLOGIC system by doing the following steps:

1. Mark connector (A) in figure 1 at CIM3F communications adapter (B) in figure 1 for circuit breaker before being tested.
2. Disconnect connector (A) from CIM3F communications adapter (B).
3. Reconnect connector (A) when testing is complete.

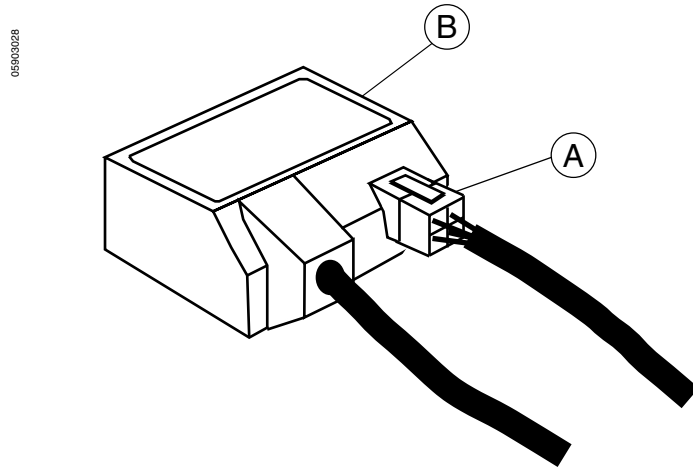

Figure 1: Communication Adapter

## Section 2—Self-Test

### CAUTION

#### HAZARD OF EQUIPMENT DAMAGE

DO NOT touch connector pins (Fig.2) when handling test modules. Touching pins can produce an electrostatic discharge resulting in damage to module or trip unit.

**Failure to follow this instruction can result in equipment damage.**

05900229

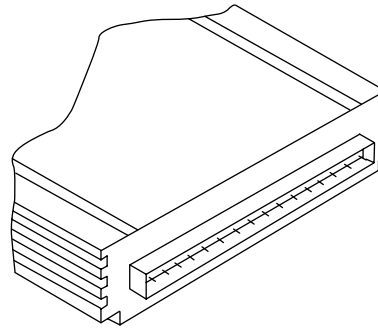

**Figure 2: Connector pins**

1. Place universal test set (fig. 3) on a flat surface. Open case until cover locks into the open position.
2. Make sure test set power is off (O) by checking position of power switch (A, Fig. 3) on keyboard (F).
3. Plug one end of test set power cord into power cord receptacle (B); plug other end into a grounded power source.
4. Insert Self-test Module (D) into module receptacle (E) in upper right corner of test set. Make sure module label is facing keyboard (F). Never use receptacle for storing modules when test set is not in use; use only module holders (C) for storage.
5. Turn power switch (A) to on (I). The red light on self-test module will glow and an identifying message will appear on the display.
6. The module will run automatically for a short period of time to insure basic operations of test set are working correctly.

*NOTE: If an error message occurs or module light fails to come on, turn power to off (O) and carefully re-seat module in receptable.*

7. If tests were successful, test set can now be used for testing circuit breakers.

### CAUTION

#### HAZARD OF EQUIPMENT DAMAGE

Test results will be inaccurate if any self-test is unsuccessful. Do not use test set to test circuit breakers if any self-test, including those which follow, is unsuccessful.

**Failure to follow this instruction can result in equipment damage.**

05900330

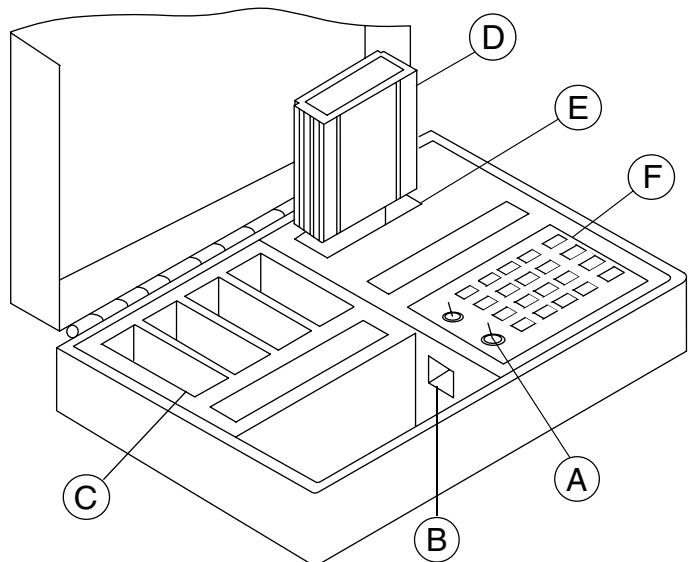

**Figure 3: Universal Test Set**



8. The test set will now prompt for optional manual testing of functions. These tests must be done on a periodic basis. To test functions, see steps 9 and 10. If manual tests are not being done, go to step 11.
9. Press keys slowly and firmly. Press SET UP key when it is flashing to return test set to the beginning of the following self-test sequence:
  - a. "TEST SYSTEM KEYBOARD?-YES/NO" checks keyboard to make sure it is accepting input correctly. If keyboard is not being tested, press NO key. To test operation of keyboard, press YES key. The display will then step through the test. If display indicates "SYSTEM KEYBOARD FAILED," see step 10A.
  - b. "TEST SYSTEM KEY LIGHTS?-YES/NO" checks the systems key backlights for proper operation. If backlights are not being tested, press NO key. To check operation of backlights, which are located behind the eight system keys (A) in Figure 4, press YES key. The display will step through the test with lights flashing in sequence down the rows. If display indicates "SYSTEM LIGHTS TEST FAILED," see step 10A.
  - c. "TEST SYSTEM L.C.D. DISPLAY?-YES/NO" checks for proper operation of LCD (liquid crystal display) characters. If LCD is not being tested, press NO key. To test LCD, press YES key. Display will then step through the test. If display indicates "SYSTEM L.C.D DISPLAY TEST FAILED," see step 10A.
10. Test set will now display test results:
  - a. If test sequence was not successful, display will so indicate. Press SET UP key to return test to beginning of test sequence and run tests again. If test sequence is again unsuccessful, note message and contact Square D for assistance (1-888-778-2733).
  - b. If test sequence was successful, Universal Test Set can now be used to test circuit breaker trip systems.
11. Turn test set power switch (B) in Figure 4 to OFF.
12. Remove self-test module and store it in module holder.
13. If no additional testing is planned, unplug test set, store power cord in storage area, and close test set case.

<b>CAUTION</b>
<b>HAZARD OF EQUIPMENT DAMAGE</b>
Test results will be inaccurate if any self-test is unsuccessful. Do not use test set to test circuit breakers if any self-test was unsuccessful.
<b>Failure to follow this instruction can result in equipment damage.</b>

055930301

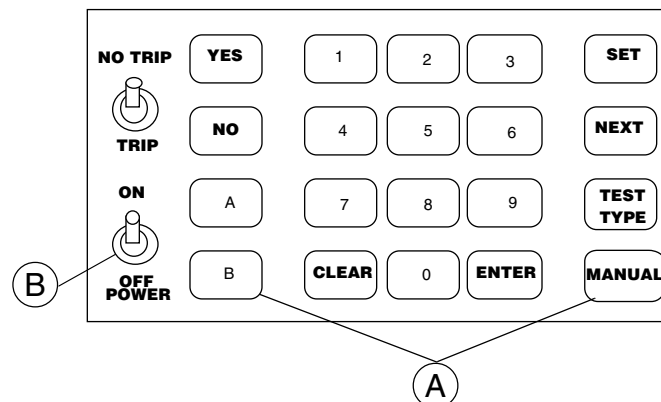

Figure 4: Test System Console

## Section 3—Test Circuit Breaker

### CAUTION

#### HAZARD OF EQUIPMENT DAMAGE

Damage to test set and module will occur if current is flowing through circuit breaker during testing. Disconnect all loads from circuit breaker. Do not CLOSE circuit breaker during testing unless all loads are disconnected.

**Failure to follow this instruction can result in equipment damage.**

When testing only SE Series 2 circuit breakers using a CBTM1 module, test set conducts ground-fault delay test using dc current. As a result, delay times are 20% shorter than circuit breaker would provide in actual operation as shown on trip curves.

A small straight-blade screwdriver is necessary for testing circuit breakers.

*NOTE: The test sequence can be stopped at any time by turning test power OFF.*

1. Disconnect all loads by (1) placing circuit breaker in OPEN position or (2) disconnecting all loads downstream from circuit breaker under test.

*NOTE: During test there must be no current flowing through circuit breaker. Any current flowing through circuit breaker will terminate test and could result in damage to test set. If circuit breaker is in OPEN position, trip solenoid test cannot be done. If downstream loads are disconnected, circuit breaker can be in either OPEN or CLOSED position. If circuit breaker is in CLOSED position, it will trip during functional tests depending upon position of TRIP/NO TRIP switch. If switch is placed in NO TRIP position, test set will not signal circuit breaker to trip during functional tests. If switch is placed in TRIP position, circuit breaker will trip during functional tests.*

2. If circuit breaker is connected to POWERLOGIC® system, disconnect POWERLOGIC system according to instructions on page 7.
3. Place test set on a flat surface no more than five feet from circuit breaker to be tested. Open case fully to lock cover into the open position (fig.5).

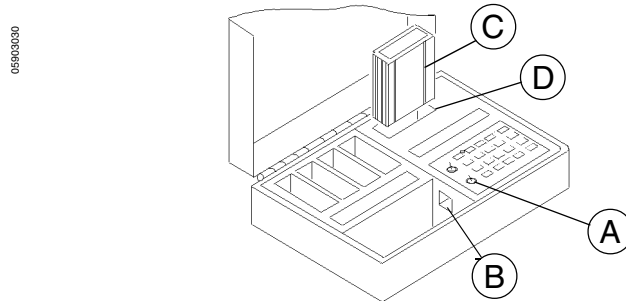

Figure 5: Universal Test Set

4. Make sure test set power is OFF by checking position of power switch (A) on keyboard.
5. Plug test set power cord into test set power cord receptacle (B). Plug other end into a grounded power source.
6. Test the test set by doing the self-test in Section 2. If self-test is unsuccessful contact Square D for assistance (1-888-778-2733) and do not use test set to test circuit breaker. If self-test was successful, proceed with step 7.

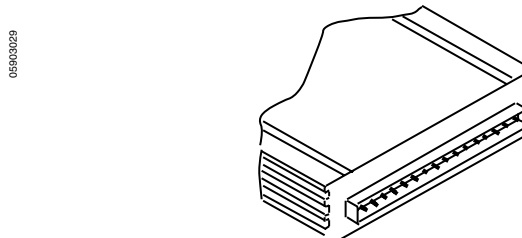

Figure 6: Connector Pins

7. See table on page 4. Select appropriate circuit breaker test module (C, fig. 5) and insert into module receptacle (D).

### CAUTION

#### HAZARD OF EQUIPMENT DAMAGE

Do not touch connector pins (Fig. 6) when handling test modules. Touching pins can produce an electrostatic discharge resulting in damage to module or trip unit.

**Failure to follow this instruction can result in equipment damage.**

- Insert test set end of umbilical cord into slot on top of module as shown by label on module. The umbilical cord is inserted with cable toward rear of module as shown in figure 7.

056903032

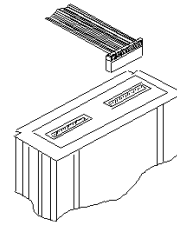

**Figure 7: Umbilical Cord**

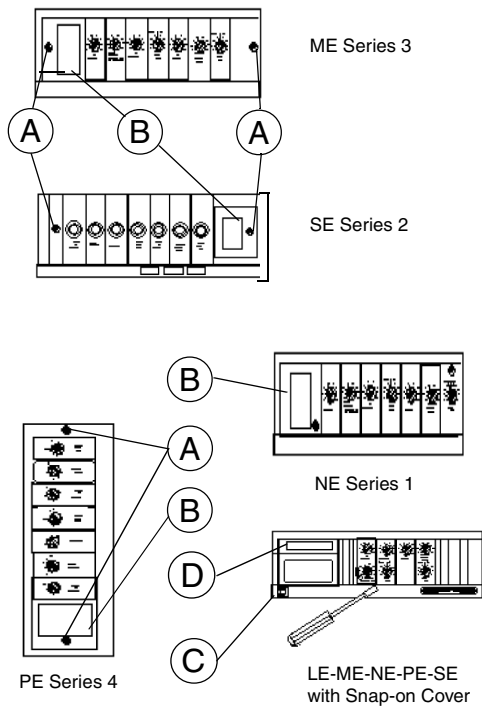

**Figure 8: Screw Retained and Snap-On Unit Covers**

- Circuit breakers with screw retained trip unit cover: Use a small screwdriver to loosen trip unit cover screws (A) and remove clear plastic trip unit cover.

Circuit breakers with snap-on trip unit cover. Insert a small screwdriver under tab of clear plastic trip unit cover and snap out the cover.

- Circuit breakers with screw retained trip unit cover: To remove any accumulated electrostatic charge, touch trip unit metal panel. Hold rating plug (B), if equipped, firmly and SLOWLY remove it from circuit breaker.

Circuit breakers with snap-on trip unit cover: If equipped with a trip indicator/ammeter (C), use a small screwdriver to carefully pry up one end and then the other, a small amount at a time, to remove the trip indicator/ammeter (C). On circuit breakers without trip indicator/ammeter, remove the black plastic cover. Remove rating plug (D) or black plastic cover.

**TRIP UNITS WITH RATING PLUGS ONLY:**

- LIGHTLY touch rating plug connector board to metal grounding surface (A, Fig. 9) next to power cord receptacle of test set to discharge any accumulated electrostatic charge.

056903034

ME Series 3, NE Series 2, or PE Series 4 Rating Plug

SE Series 3 Rating Plug

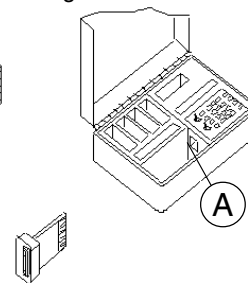

**Figure 9: Trip Units with Rating Plugs**

12. SLOWLY insert rating plug into connector on tip of module as shown by label.

*NOTE: The rating plug must be oriented as shown in figure 10 or 11.*

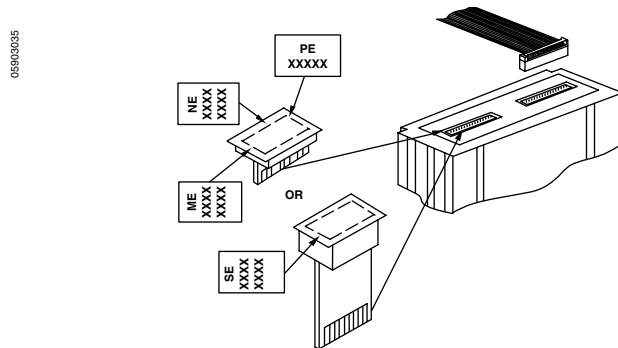

Figure 10: Rating Plug Insertion

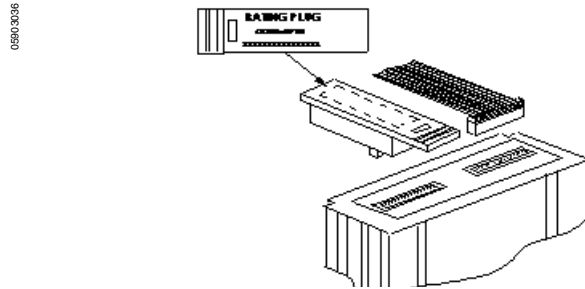
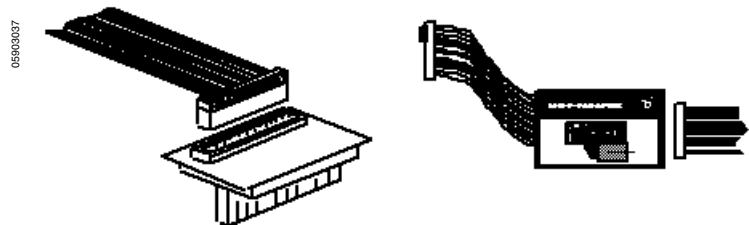

Figure 11: Rating Plug Insertion

**ALL TRIP UNITS:**

13. Carefully insert adapter end of umbilical cord into rating plug adapter or M-N-P-S Adapter (fig. 12) being careful not to bend adapter pins. Note orientation of connector. (Adapters are stored in the power and umbilical cord storage area).



ME Series 3, NE Series 1, PE Series 4 and SE Series 2

ME Series, 4, 5 and 5 A  
MX Series 4 and 5  
NE Series 2, 3, and 3A  
NX series 2 and 3  
PE Series 5, 6, and 6A  
PX Series 5 and 6  
SE Series 3 and 3A



LE/LX Series 1B  
ME Series 5B  
MX Series 5B  
NE Series 3B  
NX Series 3B  
PE Series 6B  
PX Series 6B  
SE Series 3B

Figure 12: Rating Plug Adapter and M-N-P-S Adapter

14. Grasp adapter firmly and touch adapter connector board lightly against metal grounding surface (A, fig. 9) next to power cord receptacle.
15. Immediately install adapter SLOWLY into trip unit. Note orientation of umbilical cord and adapter (A, fig. 13).

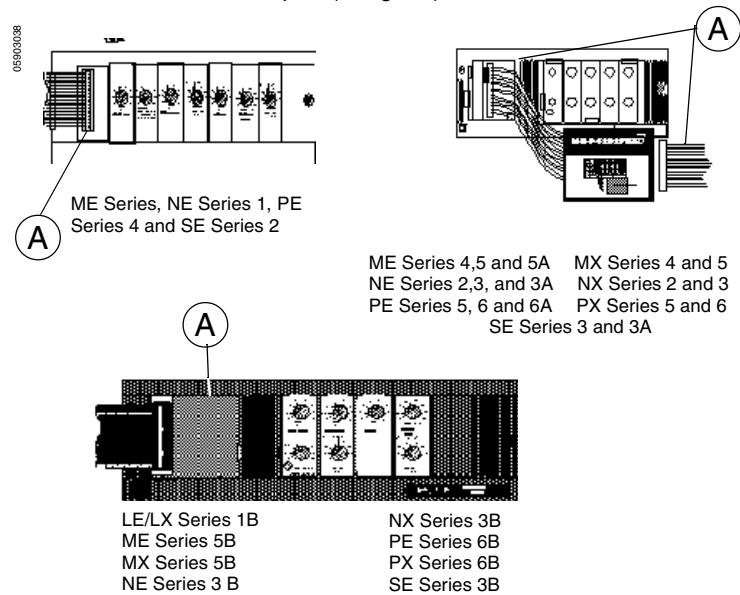

**Figure 13: Orientation of Umbilical Cord and Adapter**

16. Turn test set power switch on (I). The test set will perform a self-test. After self-test, module identifier will be displayed.
  17. Refer to test procedure for the test module being used and begin testing. The test set will request information on frame size and trip unit function.. After all information has been entered and verified, test set will ask for "TEST TYPE." See section 1 for test type. Enter test type and continue with test.
- NOTE: If "TEST FAILED" message appears in the display window, check to see if circuit breaker is connected to a POWERLOGIC system. If circuit breaker is connected to POWERLOGIC system, disconnect POWERLOGIC system according to instructions on page 7 and press A to repeat test. If "TEST FAILED" appears again, call Square D (1-888-778-2733).*
18. After test has been completed, turn test set power switch to off (O).
  19. Slowly remove adapter from trip unit by holding adapter housing firmly and removing it from trip unit.
  20. Remove adapter from umbilical cord and store in storage space.
  21. Remove umbilical cord from module. Store umbilical cord in storage space.
  22. Hold rating plug housing, if equipped, firmly and slowly remove it from the module. Lightly touch rating plug connector to metal grounding surface next to power cord receptacle.
  23. Slowly insert rating plug and trip indicator/ammeter or black plastic covers into slots in circuit breaker.
  24. Replace clear trip unit cover and secure trip unit cover screws, if equipped.
  25. Remove test module and install in module holder. Do not touch connector pins. Disconnect test set, store power cord, and close cover.

# Section 4—MICROLOGIC Series B CBTMB Test Module

## TEST SETUP

05P03039

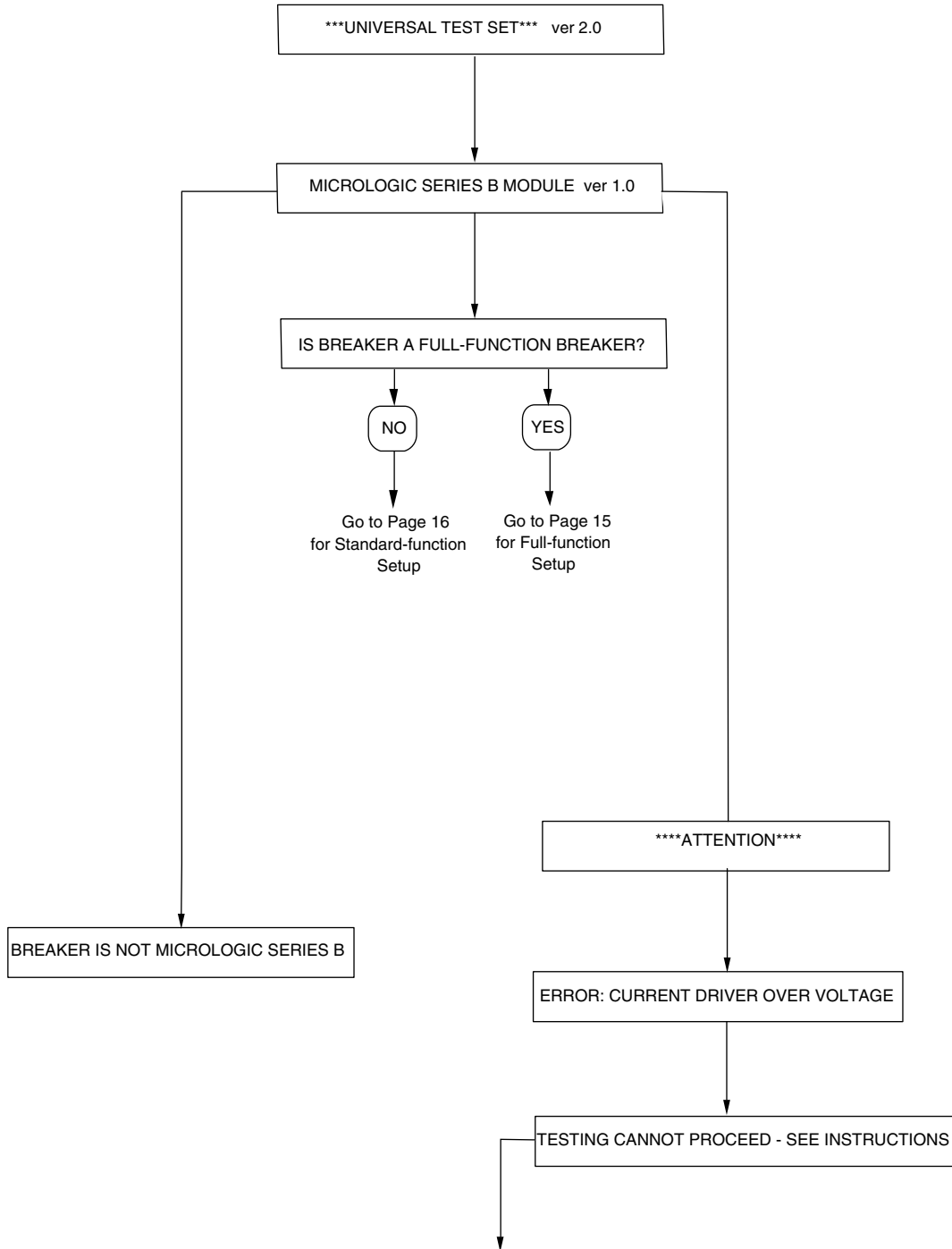

Turn test set power OFF (O). Remove and reseal test module. Check connections of umbilical cord, rating plug and rating plug adapter. Turn test set power ON (I) to restart test. If "TESTING CANNOT PROCEED" message appears again, call Square D (1-888-778-2733.)

**TEST SETUP FOR FULL-FUNCTION  
CIRCUIT BREAKERS**

05903040

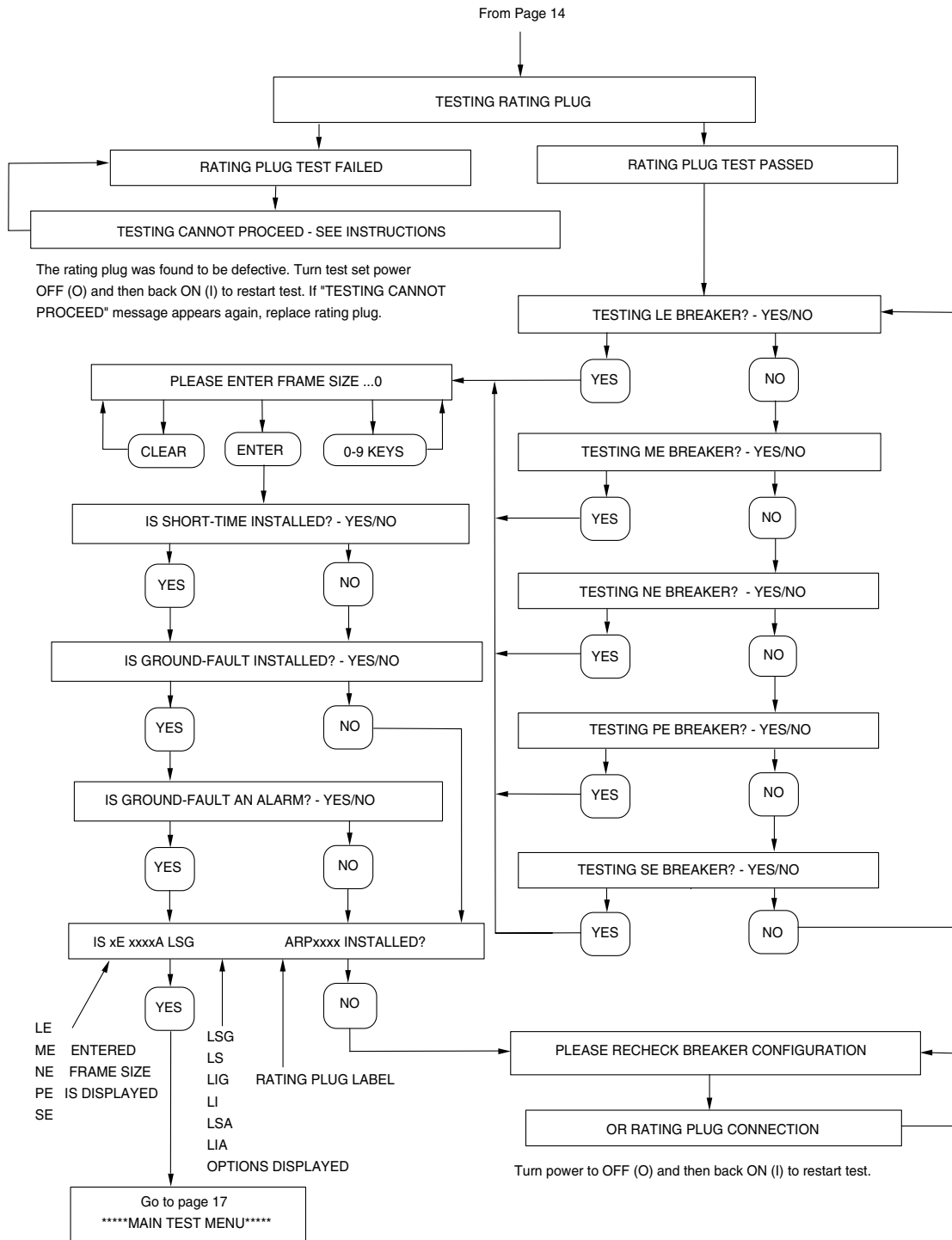

**TEST SETUP FOR STANDARD-FUNCTION CIRCUIT BREAKERS**

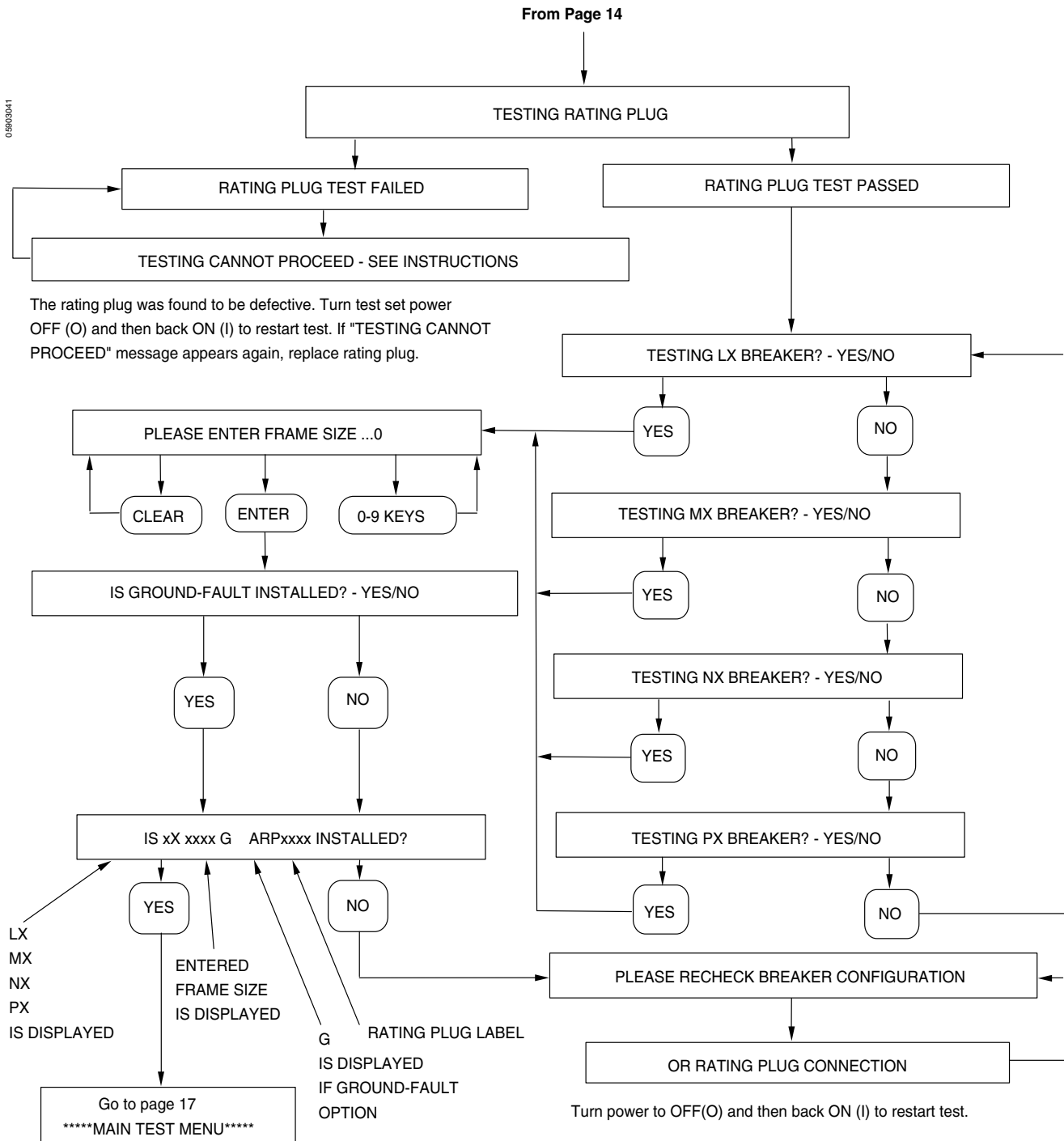



## MAIN TEST MENU

059003042

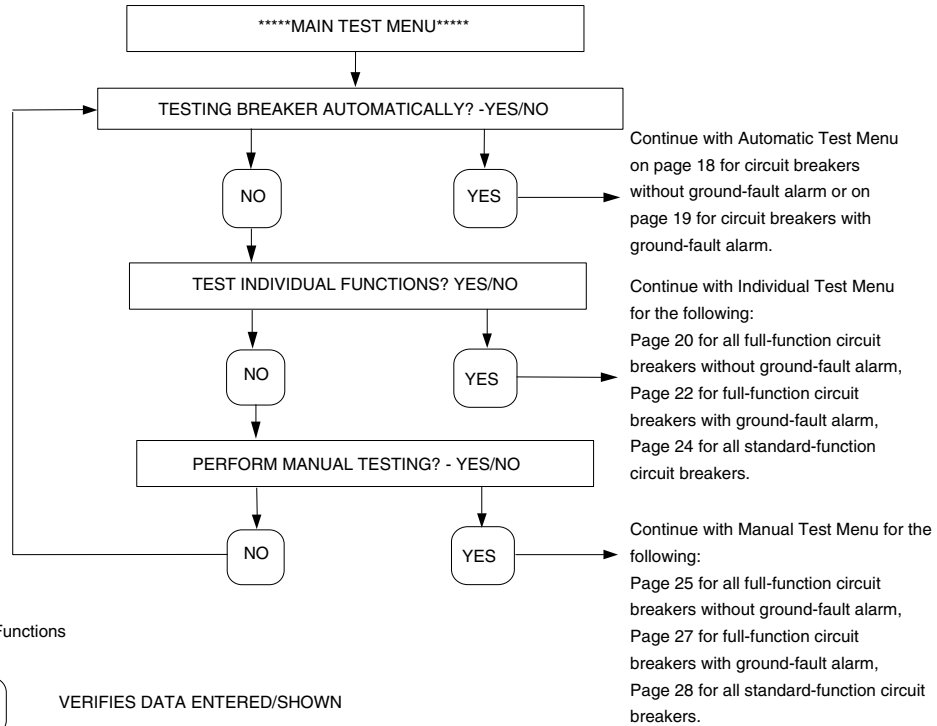

### Description of Key Functions

YES	VERIFIES DATA ENTERED/SHOWN
NO	NEGATIVE RESPONSE TO DATA SHOWN
A	ENTERED AFTER TRIP UNIT FUNCTION SWITCH IS SET
B	NOT USED
CLEAR	DELETES ENTRY
SET UP	NOT USED
ENTER	SIGNIFIES END OF ENTRY
NEXT	NOT USED
MANUAL	NOT USED
TEST TYPE	RETURNS UNIT TO MAIN TEST MENU

*NOTE: An option is valid any time its key is flashing.*

*NOTE: Test sequence can be stopped at any time by turning the test set power to OFF (O).*

**AUTOMATIC TEST MENU FOR ALL  
 CIRCUIT BREAKERS WITHOUT  
 GROUND-FAULT ALARM**

05903043

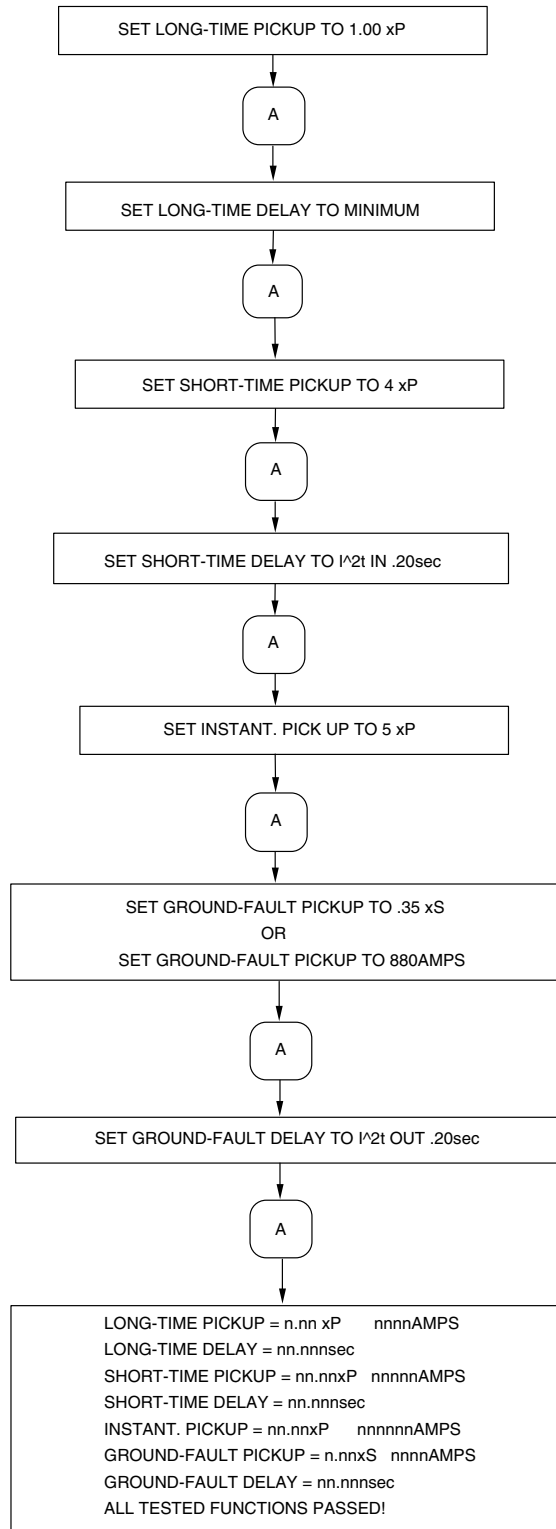

### AUTOMATIC TEST MENU FOR CIRCUIT BREAKERS WITH GROUND-FAULT ALARM

05903044

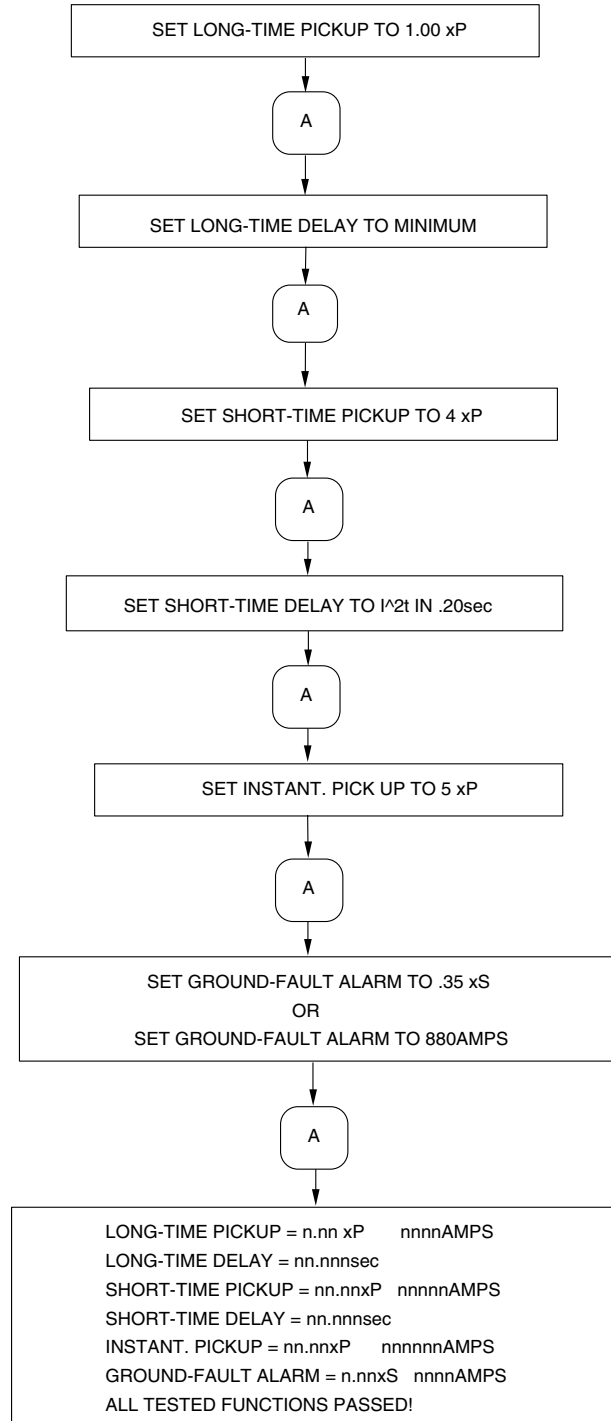

**INDIVIDUAL TEST MENU FOR ALL  
 FULL-FUNCTION CIRCUIT BREAKERS  
 WITHOUT GROUND-FAULT ALARM**

05903045

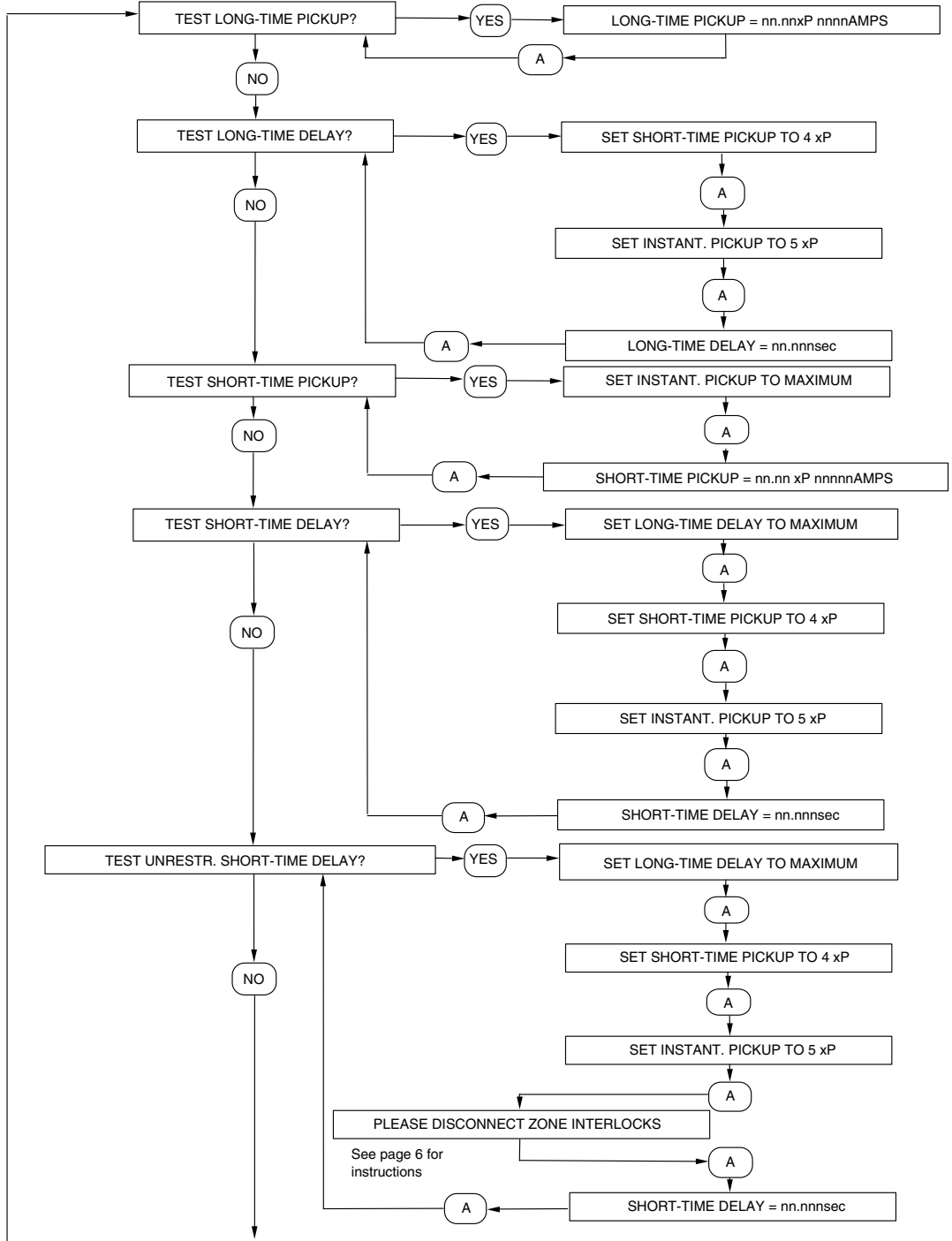

(Continued on next page)

**INDIVIDUAL TEST MENU FOR ALL FULL-FUNCTION CIRCUIT BREAKERS WITHOUT GROUND-FAULT ALARMS** (—Continued)

05900046

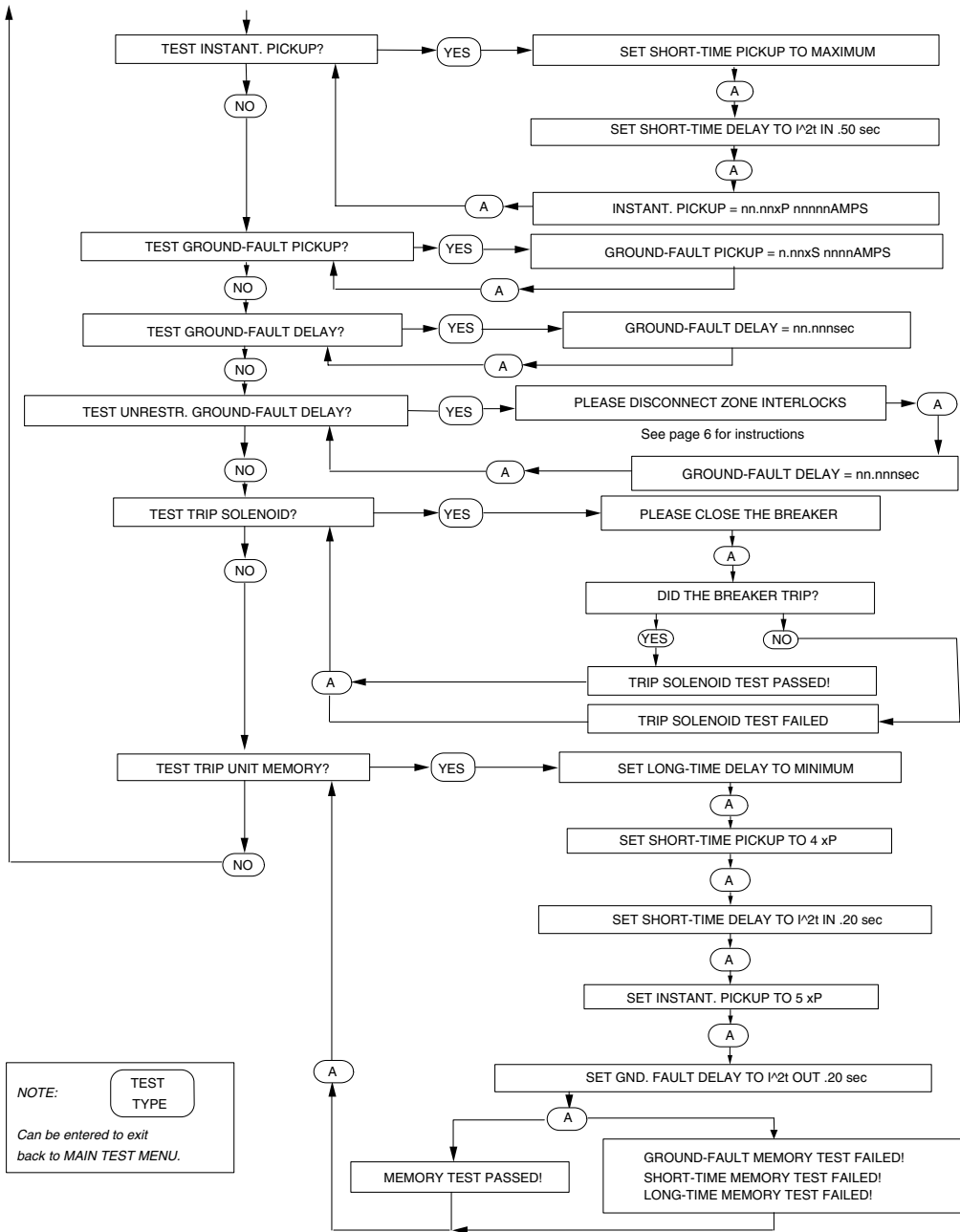

**INDIVIDUAL TEST MENU FOR FULL-FUNCTION CIRCUIT BREAKERS WITH GROUND-FAULT ALARM**

05903045

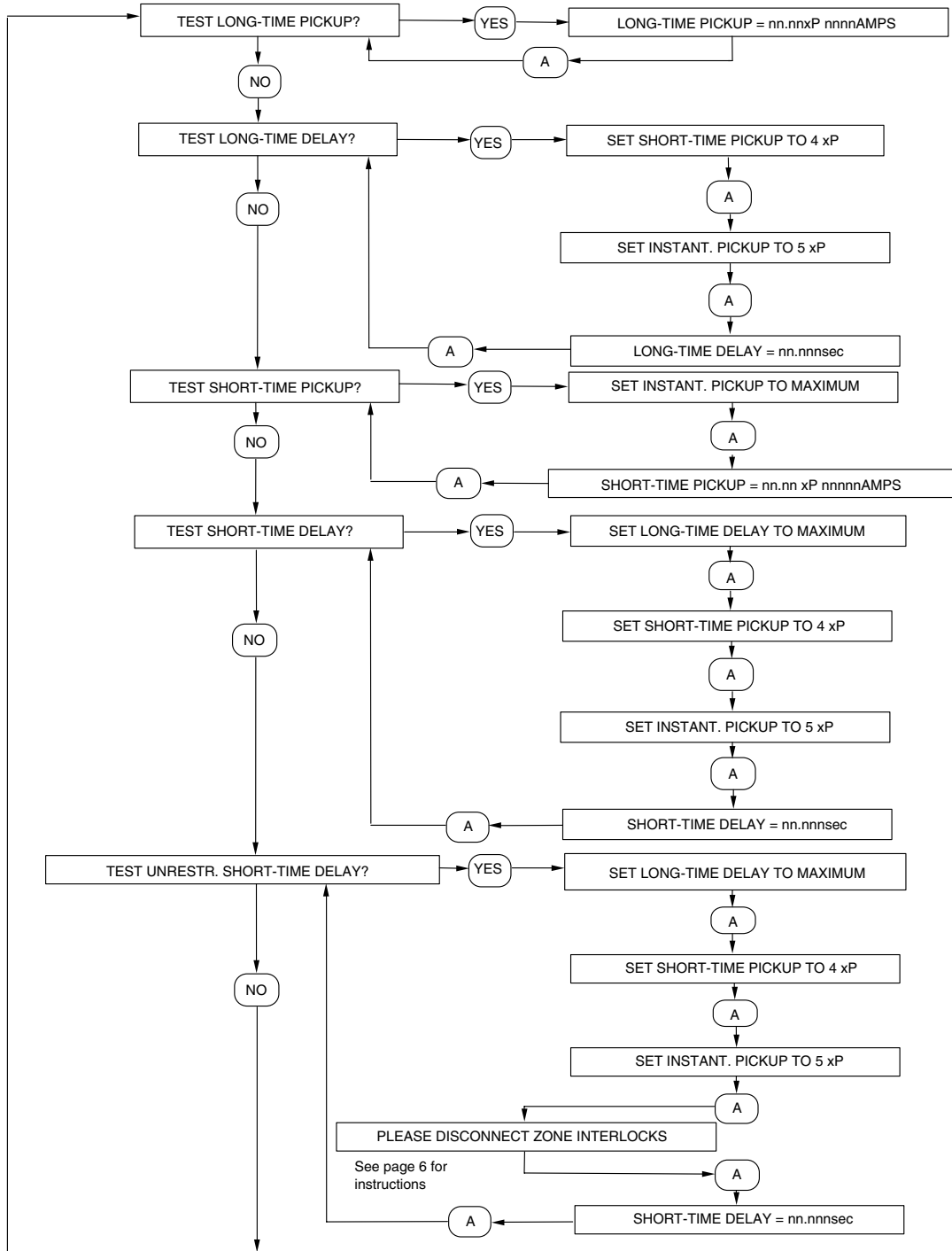

(Continued on next page)

**INDIVIDUAL TEST MENU FOR FULL-FUNCTION CIRCUIT BREAKERS WITH GROUND-FAULT ALARM** (-Continued)

05530A47

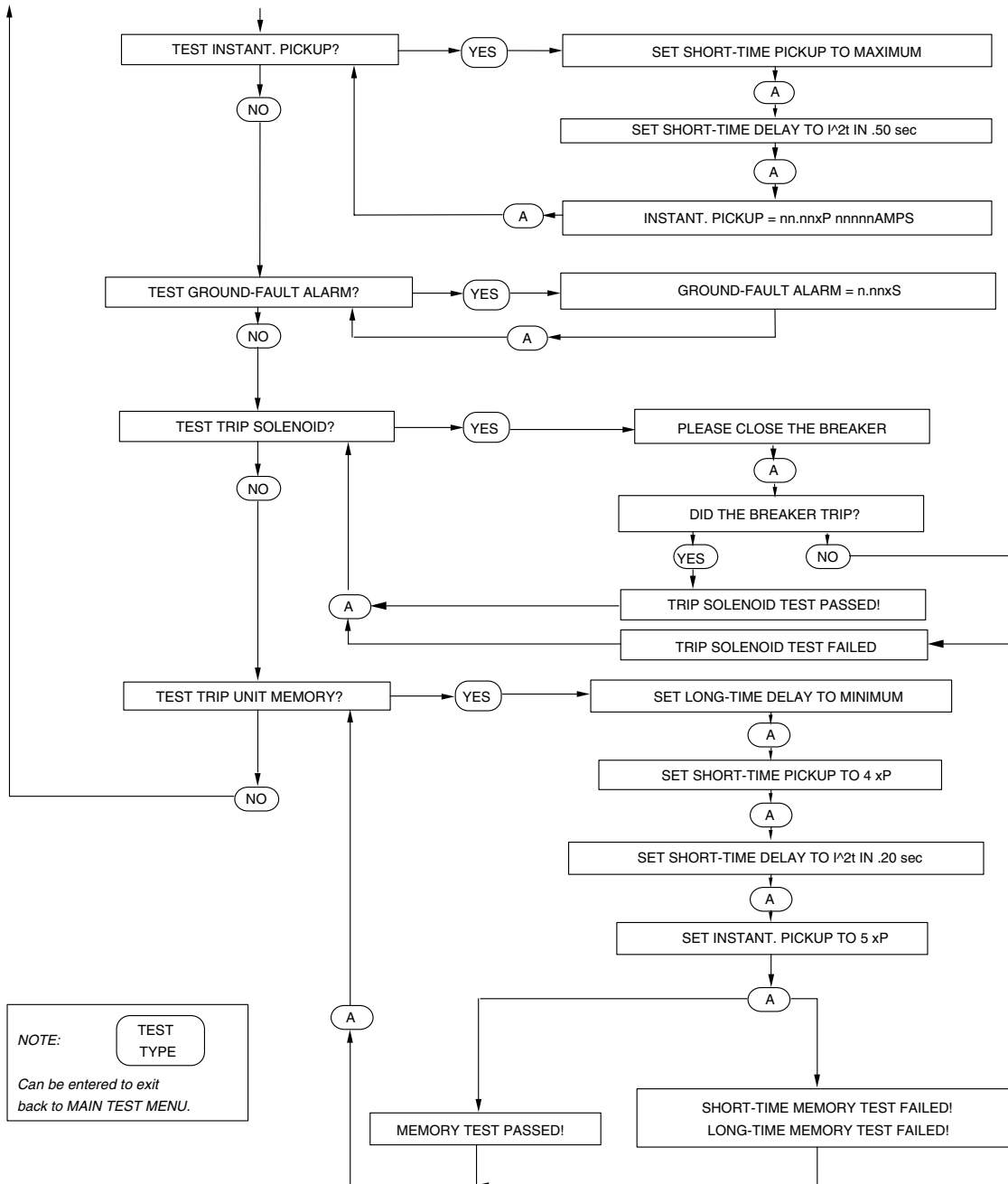

**INDIVIDUAL TEST MENU FOR  
 ALL STANDARD-FUNCTION  
 CIRCUIT BREAKERS**

05903048

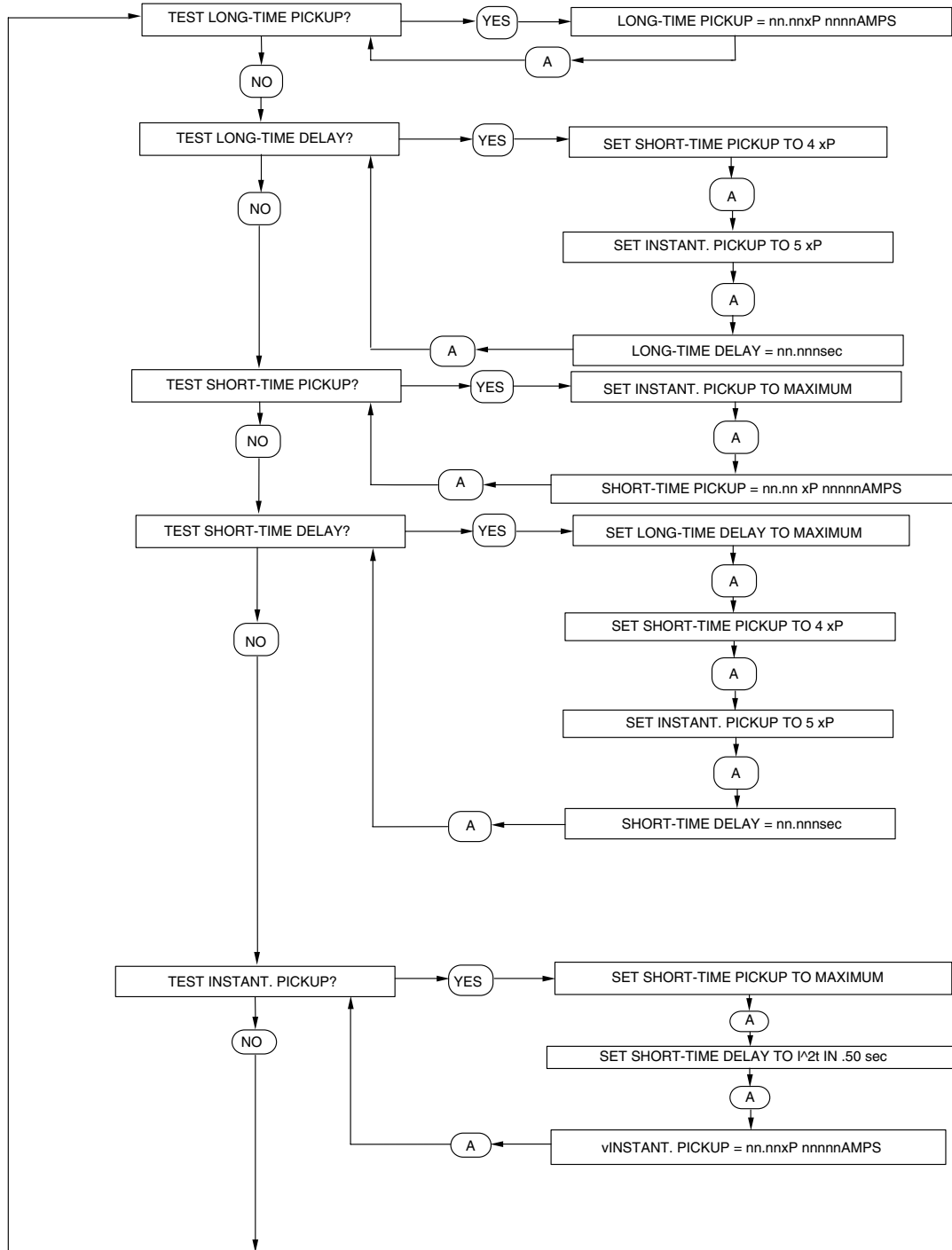

(Continued on next page)



**INDIVIDUAL TEST MENU FOR ALL  
STANDARD-FUNCTION CIRCUIT  
BREAKERS** *-Continued*

05903049

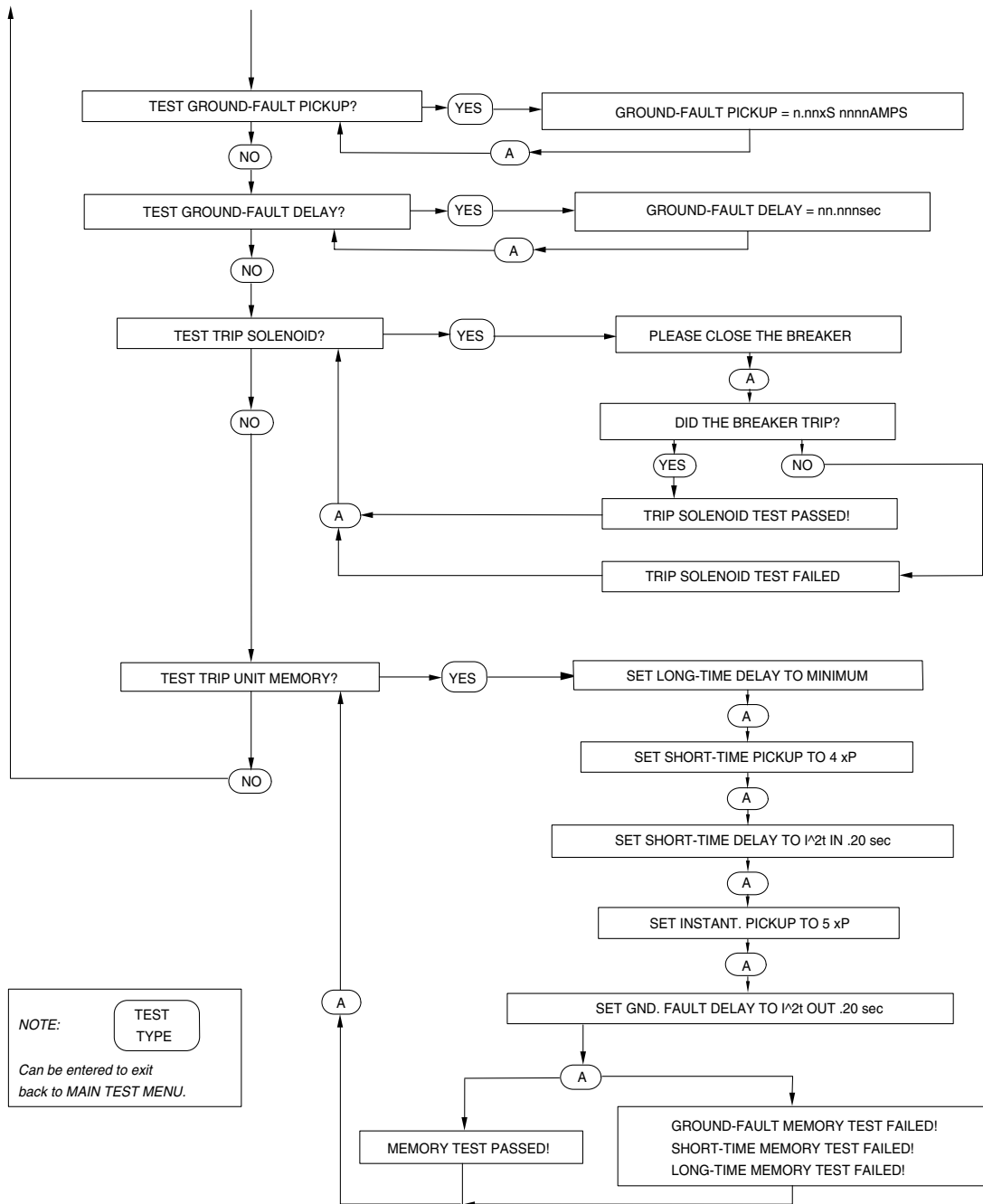

**MANUAL TEST MENU FOR ALL FULL-FUNCTION CIRCUIT BREAKERS WITHOUT GROUND-FAULT ALARM**

059103650

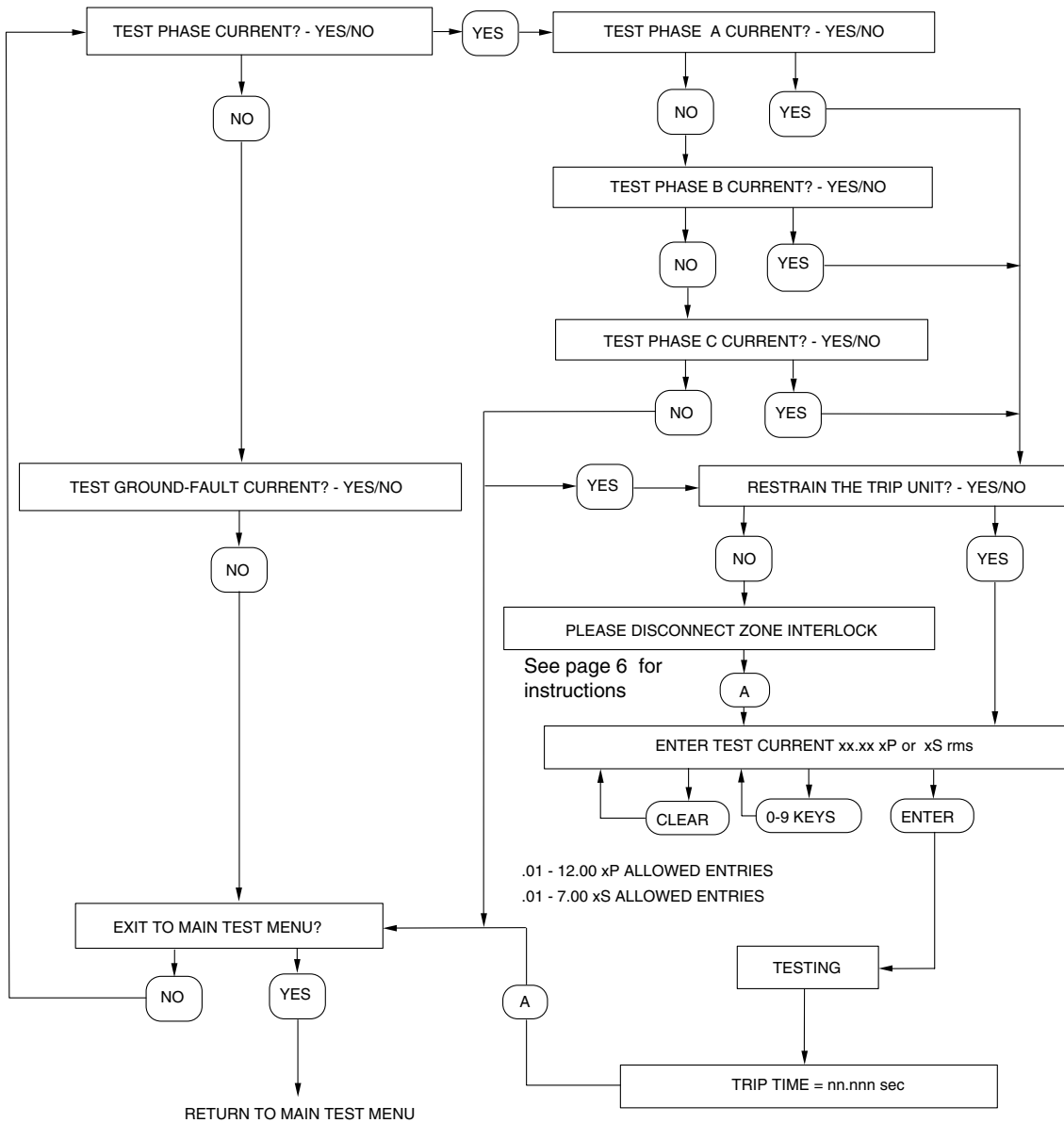

**NOTE:** TEST TYPE  
 Can be entered during testing to interrupt the test.

**MANUAL TEST MENU FOR FULL-FUNCTION CIRCUIT BREAKERS WITH GROUND-FAULT ALARM**

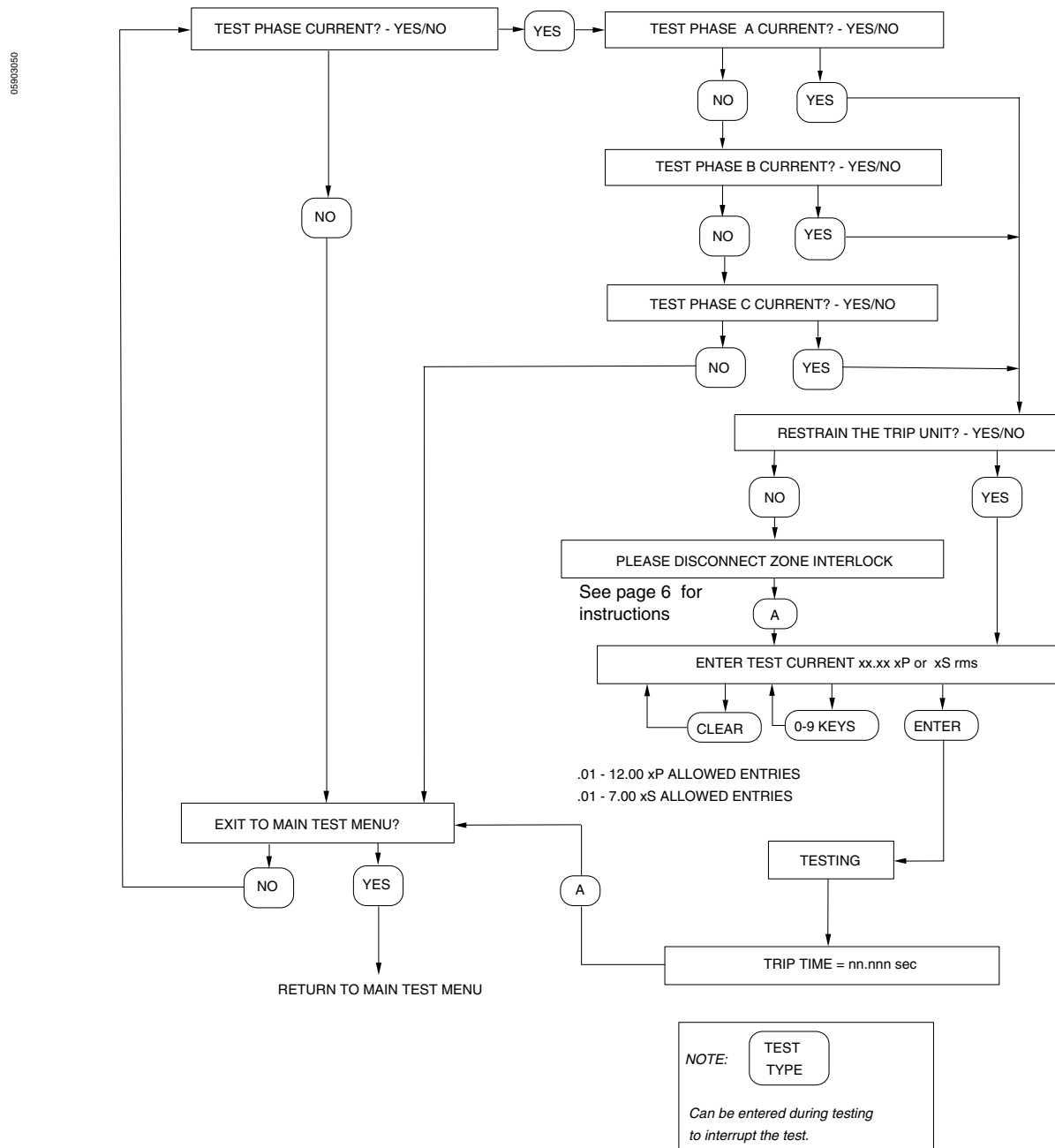

**MANUAL TEST MENU FOR ALL  
 STANDARD-FUNCTION CIRCUIT  
 BREAKERS**

05903052

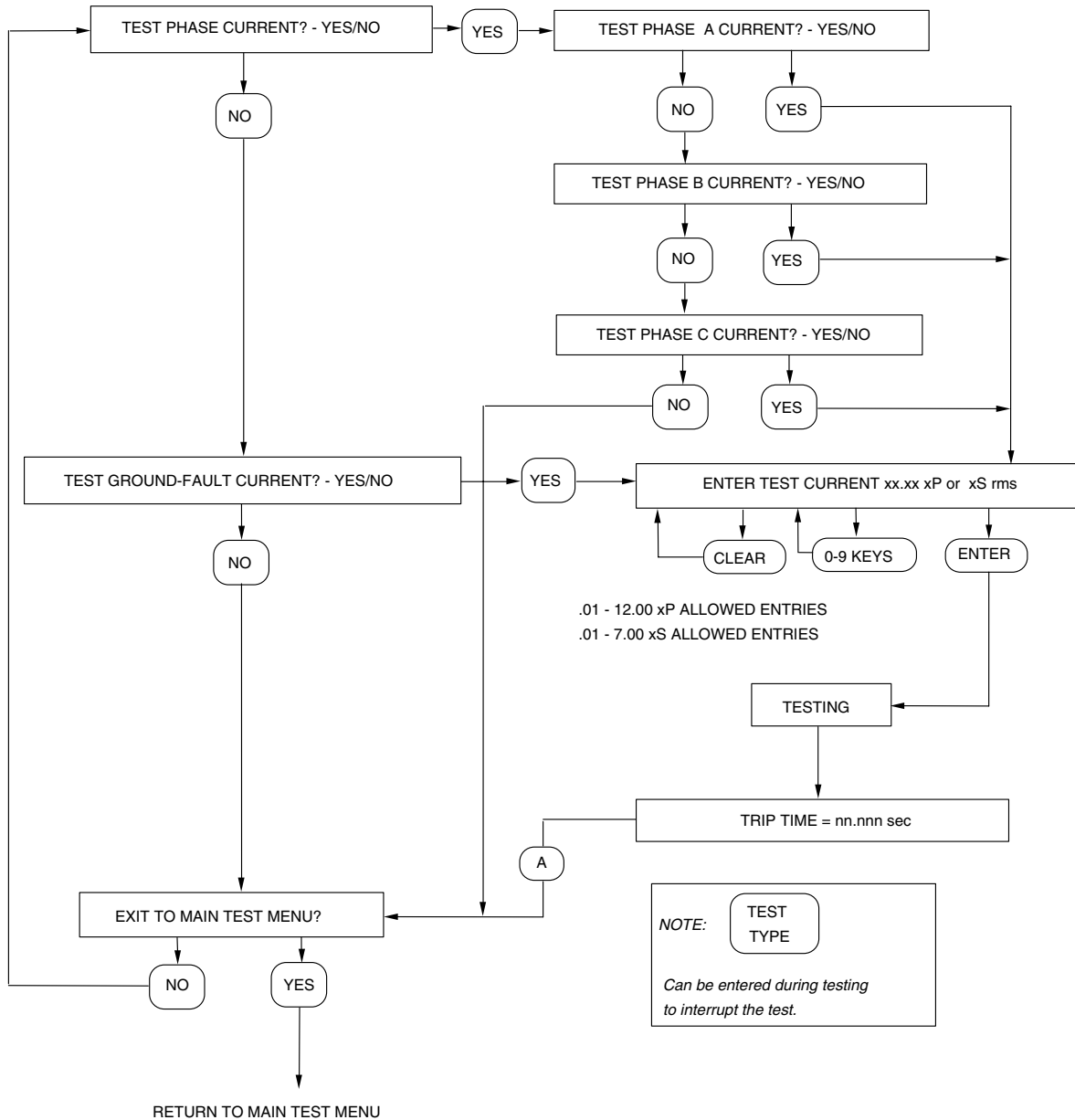

# Section 5—M-N-P-S CBTM4A Test Module

## TEST SETUP FOR FULL-FUNCTION CIRCUIT BREAKERS

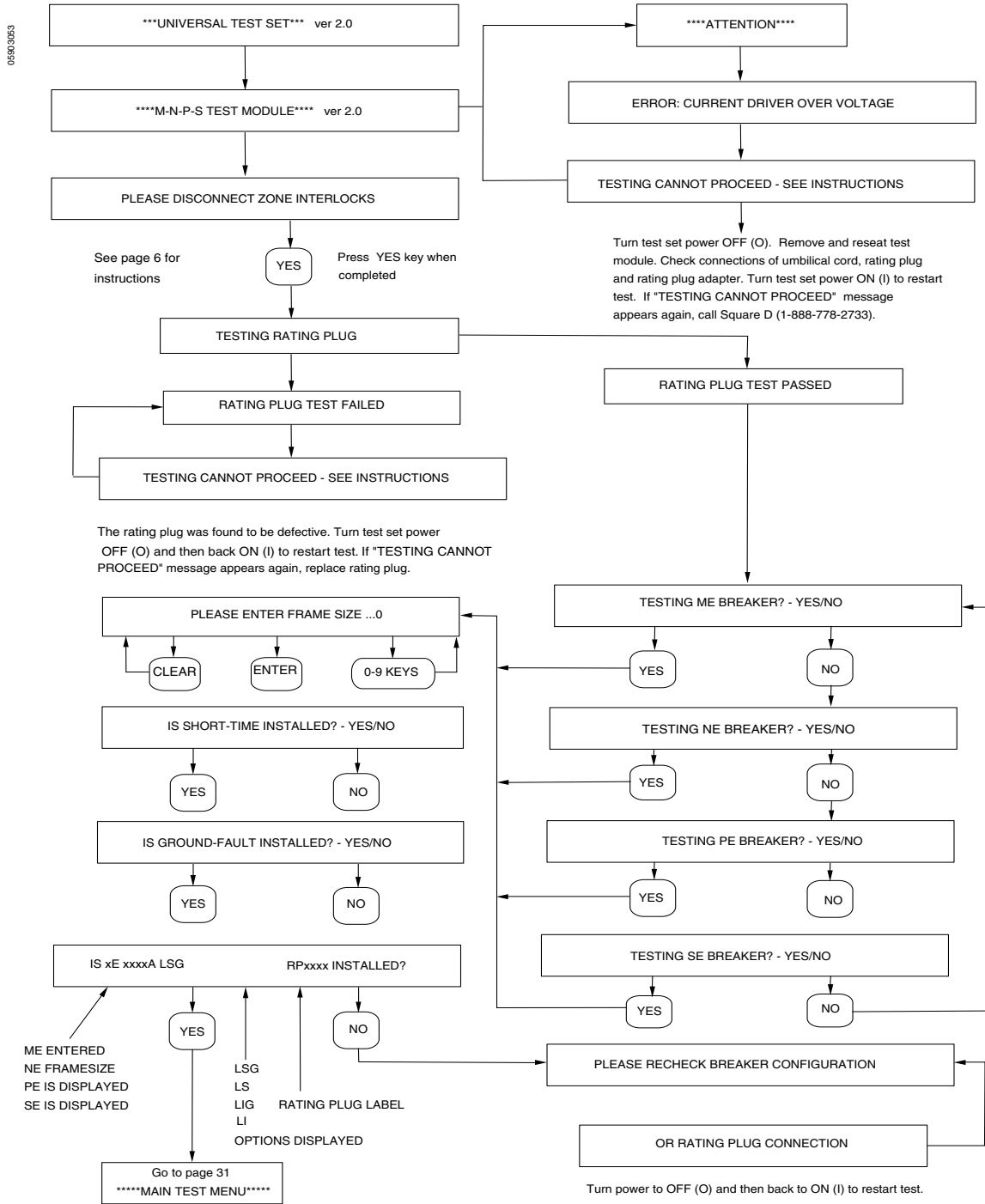

### TEST SETUP FOR STANDARD-FUNCTION CIRCUIT BREAKERS

05903054

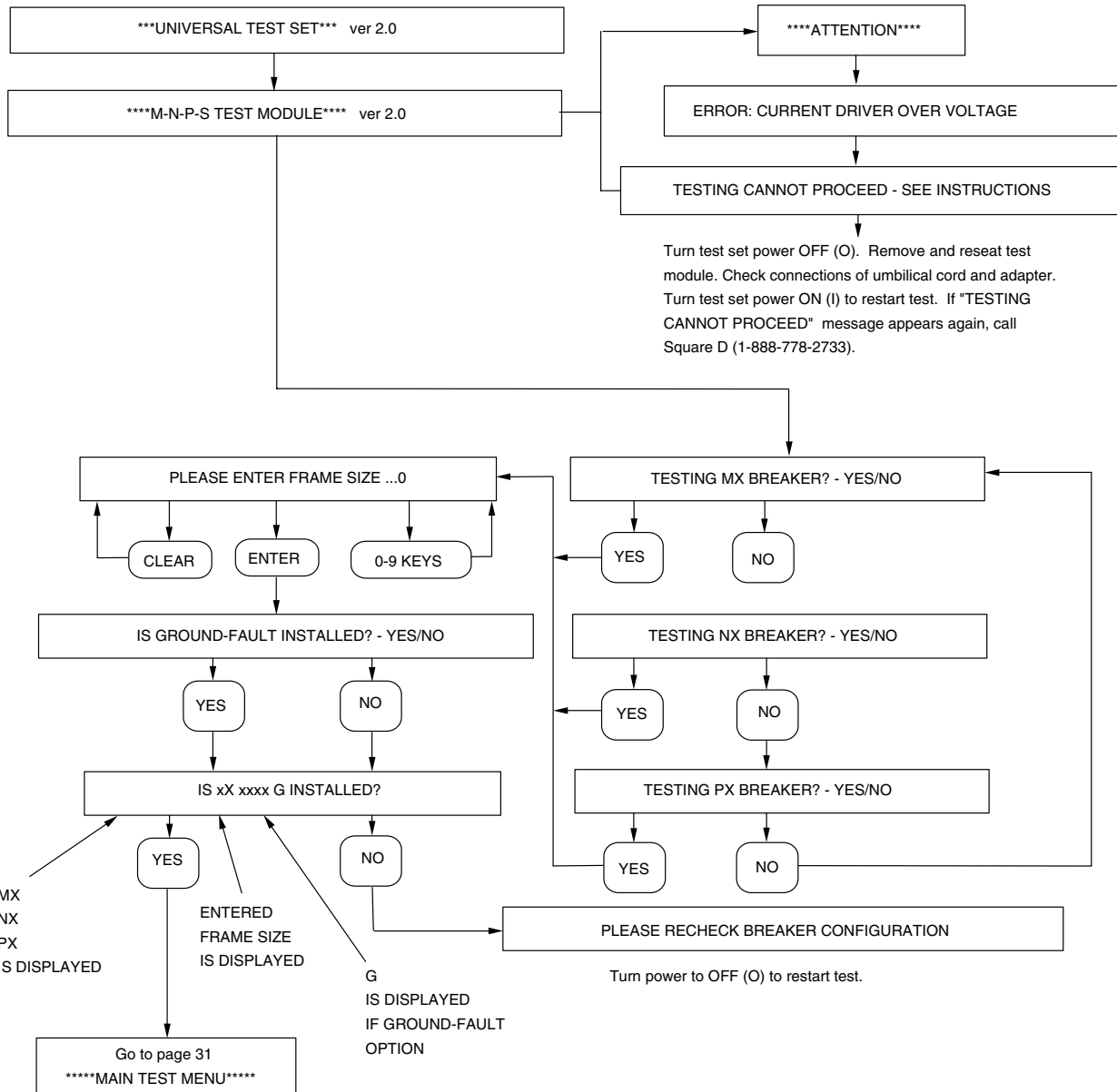

**MAIN TEST MENU**

05903065

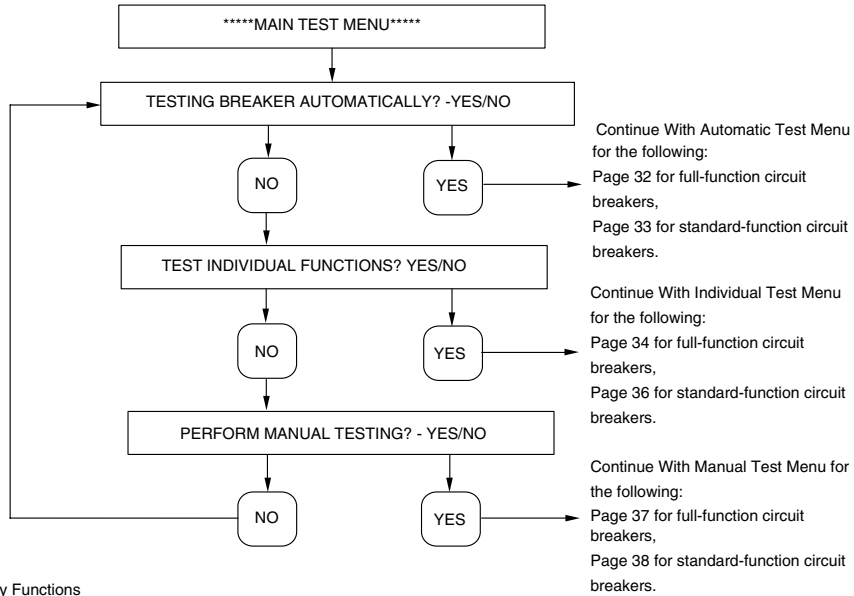

Description of Key Functions

- VERIFIES DATA ENTERED/SHOWN
- NEGATIVE RESPONSE TO DATA SHOWN
- ENTERED AFTER TRIP UNIT FUNCTION SWITCH IS SET
- NOT USED
- DELETES ENTRY
- NOT USED
- SIGNIFIES END OF ENTRY
- NOT USED
- NOT USED
- RETURNS UNIT TO MAIN TEST MENU

*NOTE: An option is valid any time its key is flashing.*

*NOTE: Test sequence can be stopped at any time by turning the test set power to OFF.*

**AUTOMATIC TEST MENU FOR FULL-FUNCTION CIRCUIT BREAKERS**

05603043

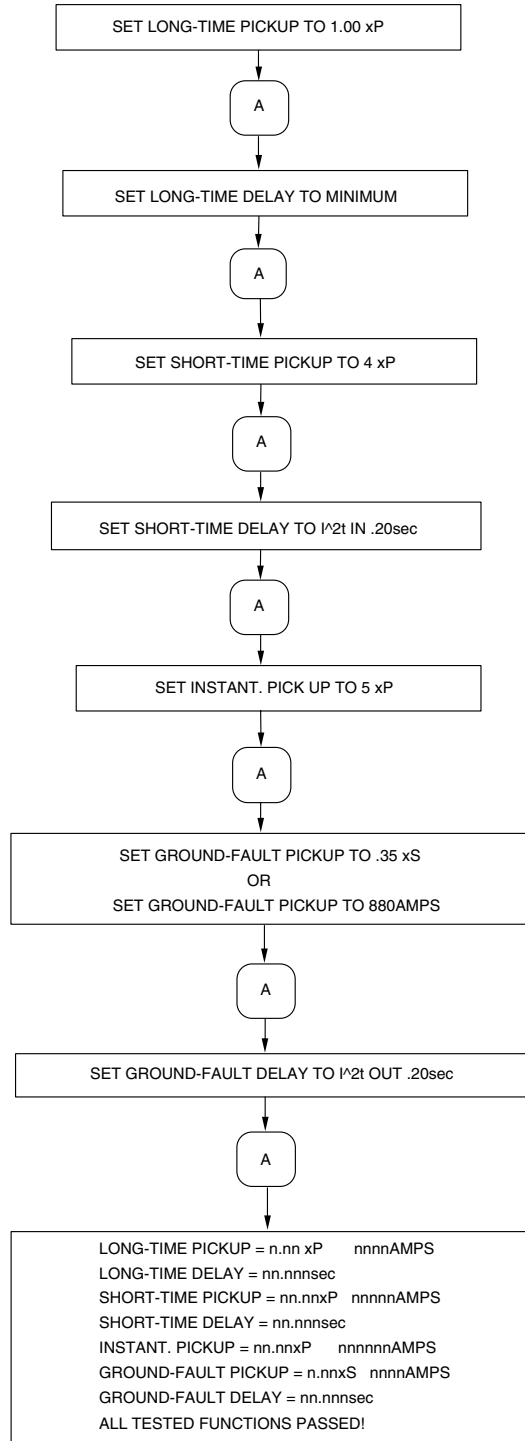



### AUTOMATIC TEST MENU FOR STANDARD-FUNCTION CIRCUIT BREAKERS

059003659

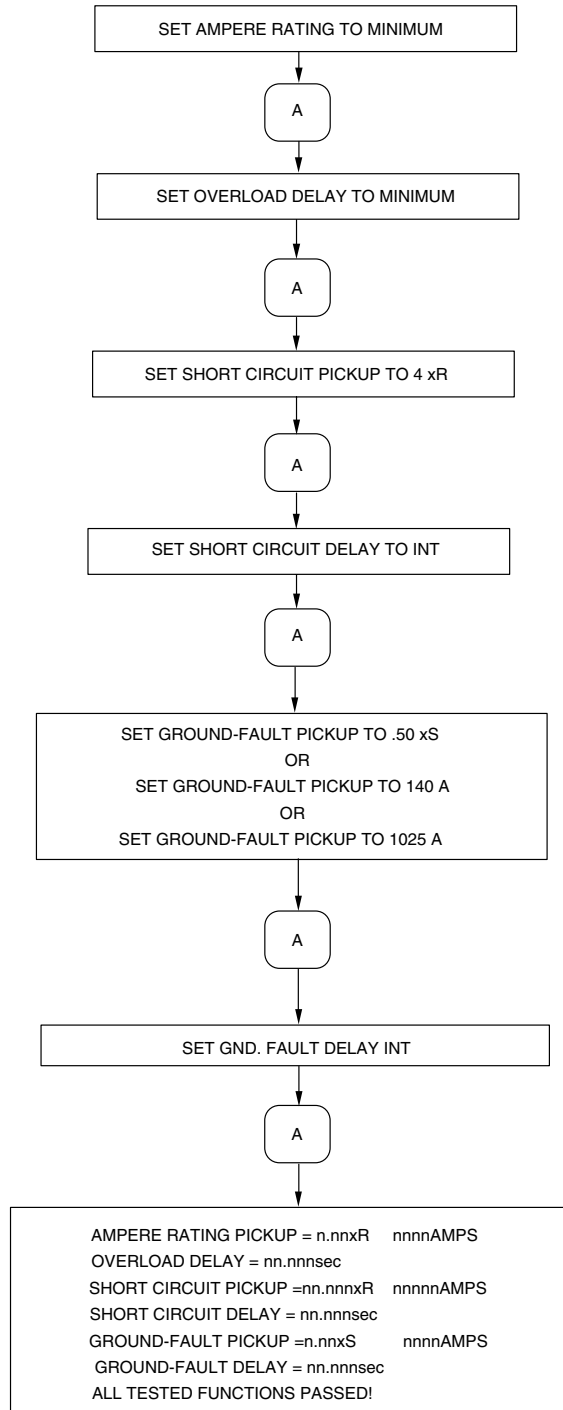

**INDIVIDUAL TEST MENU FOR FULL-FUNCTION CIRCUIT BREAKERS**

06.9003075

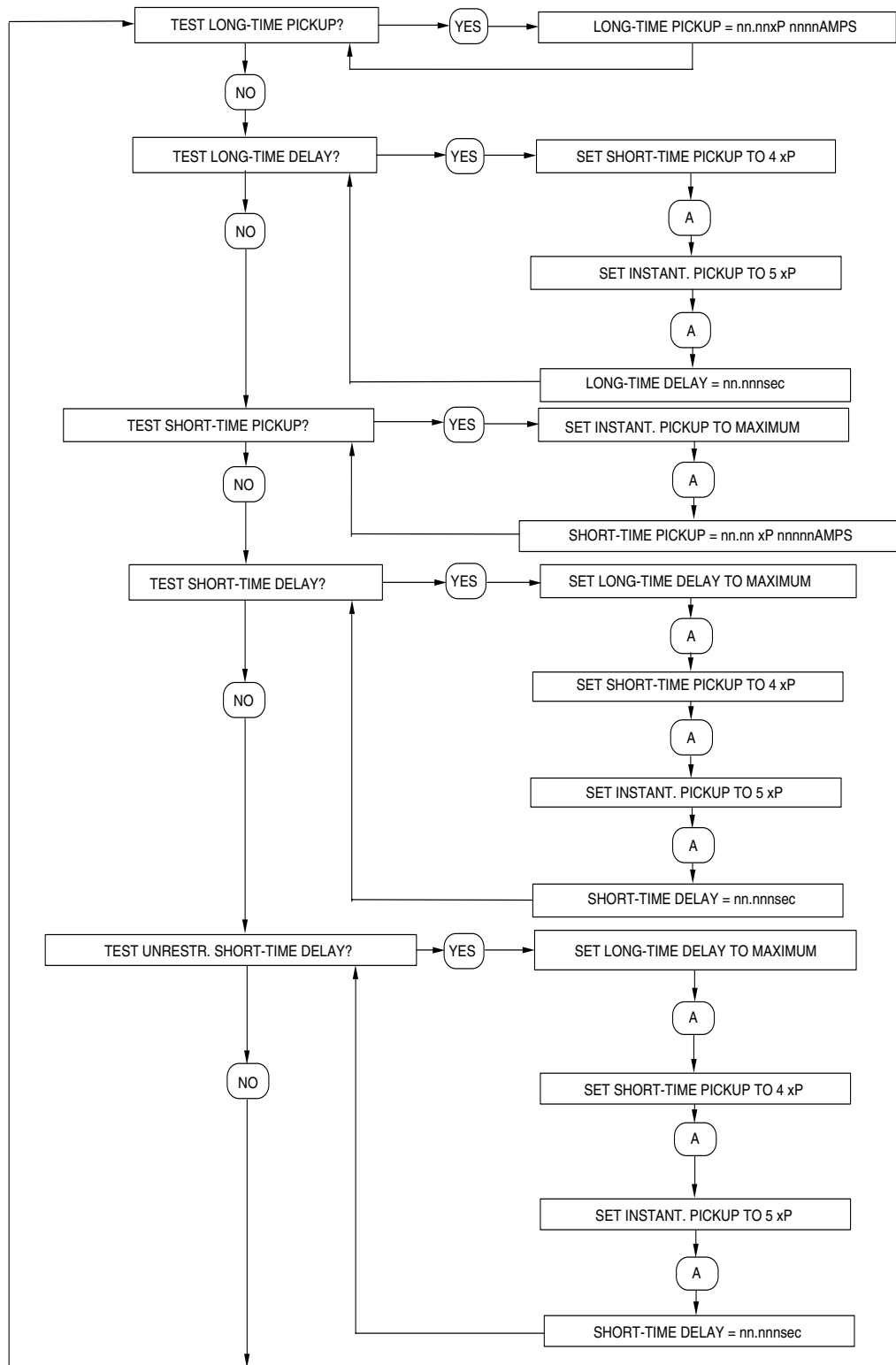

(Continued on next page)

**INDIVIDUAL TEST MENU FOR FULL-FUNCTION CIRCUIT BREAKERS-**  
-Continued

05900657

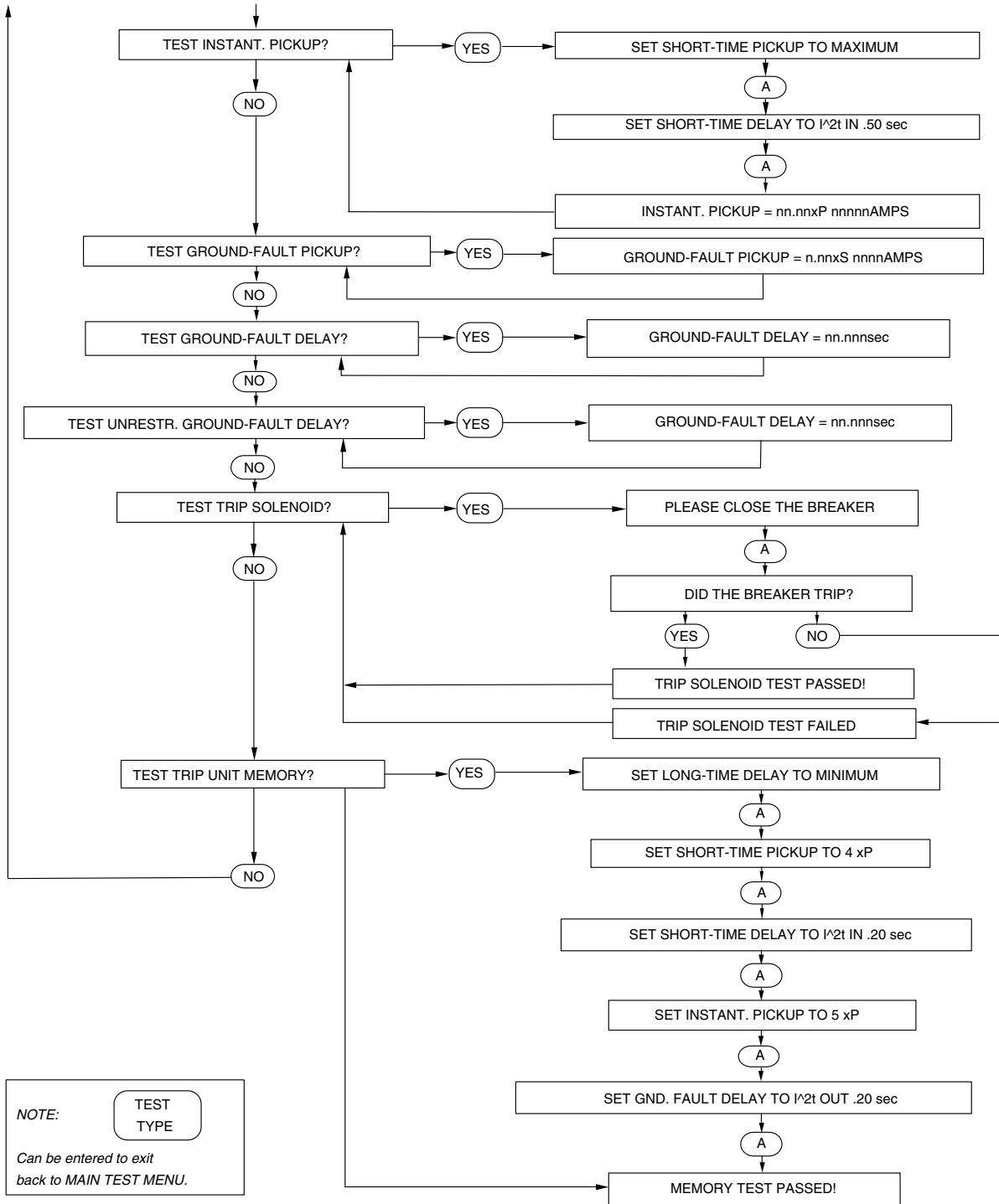

**INDIVIDUAL TEST MENU FOR  
STANDARD-FUNCTION CIRCUIT  
BREAKERS**

05900066

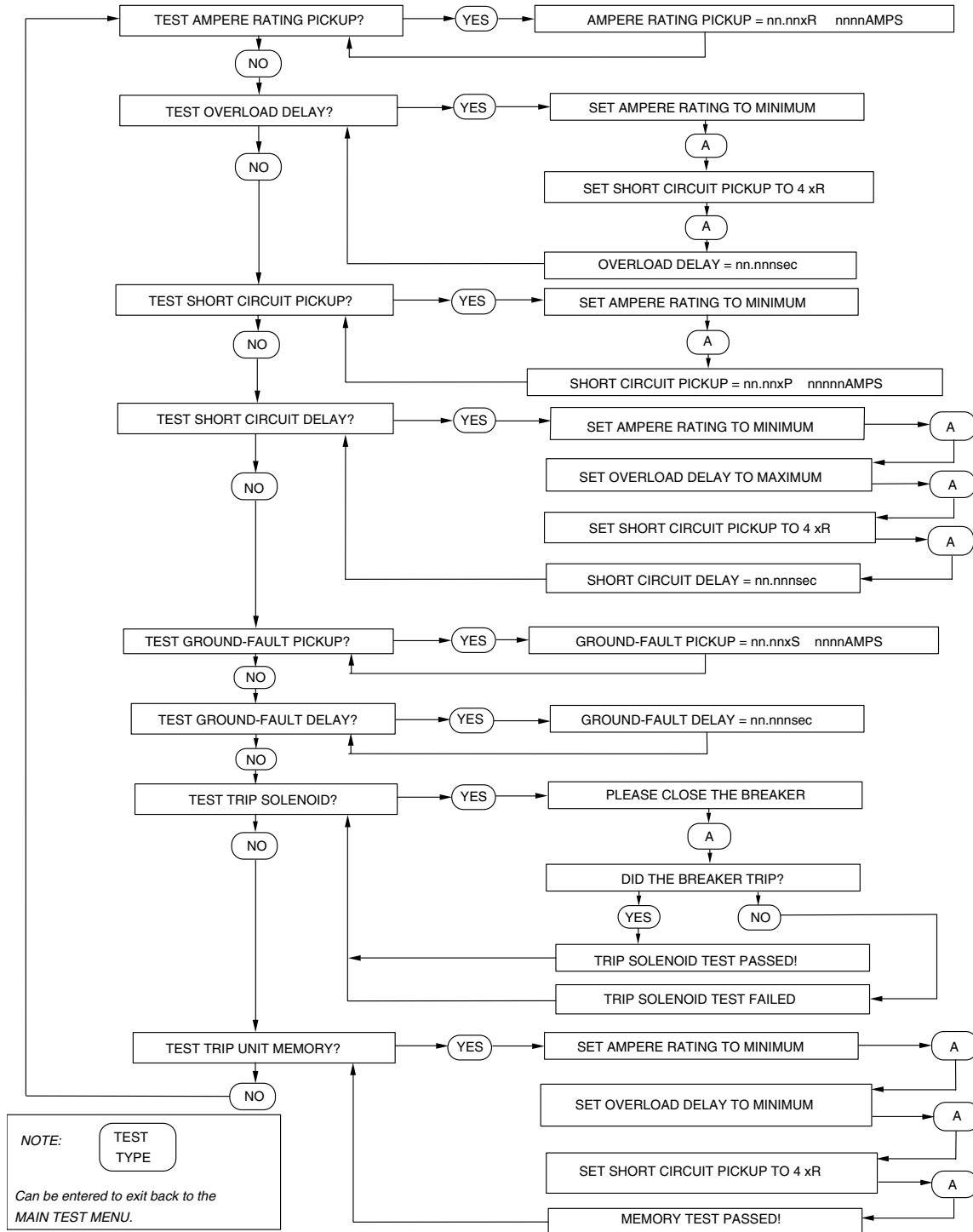

**MANUAL TEST MENU FOR FULL-FUNCTION CIRCUIT BREAKERS**

059030610

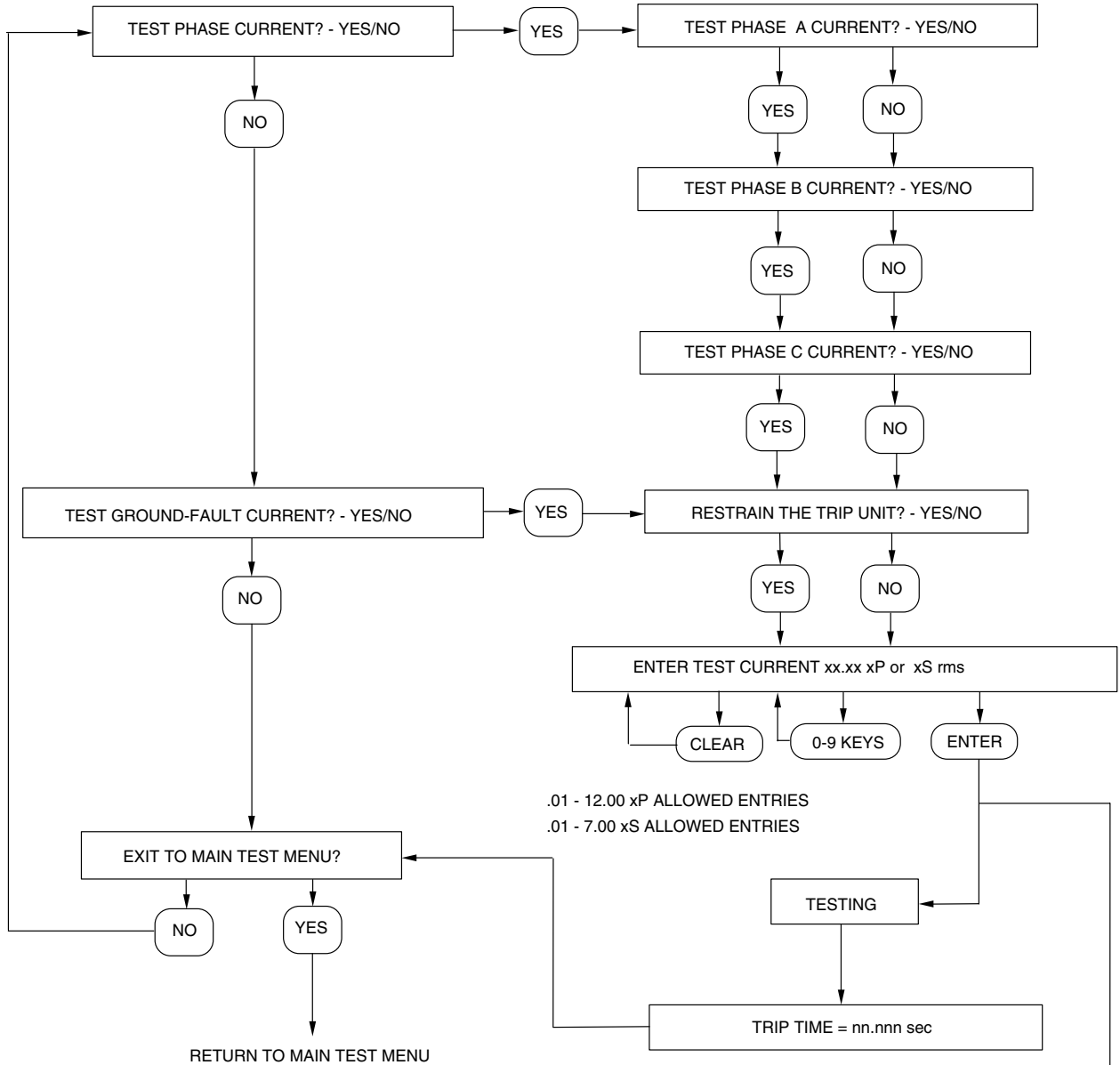

.01 - 12.00 xP ALLOWED ENTRIES  
.01 - 7.00 xS ALLOWED ENTRIES

**NOTE:** TEST TYPE  
Can be entered during testing to interrupt the test.

**NOTE:** If "ERROR: EXCEEDED CURRENT DRIVER LIMIT" OR "TEST INTERRUPTED TO AVOID OVERHEATING!" message appears, the test current entered cannot be tested on more than one phase at a time. Repeat testing phase current by answering Yes to one "TEST PHASE CURRENT? YES/NO" question at a time.

**MANUAL TEST MENU FOR  
 STANDARD-FUNCTION CIRCUIT  
 BREAKERS**

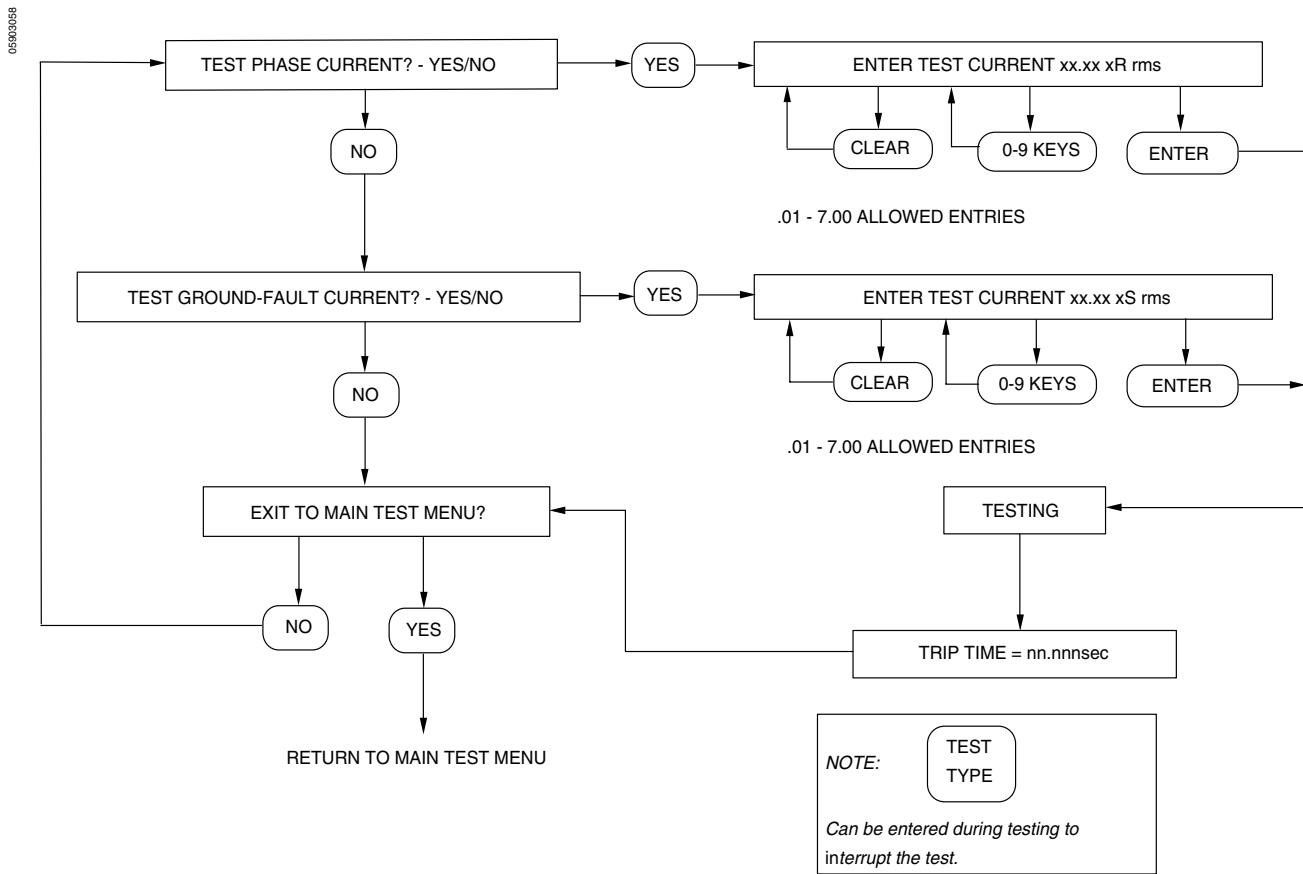

# Section 6—SE CBTM1 Test Module

## TEST SETUP

0.9903061

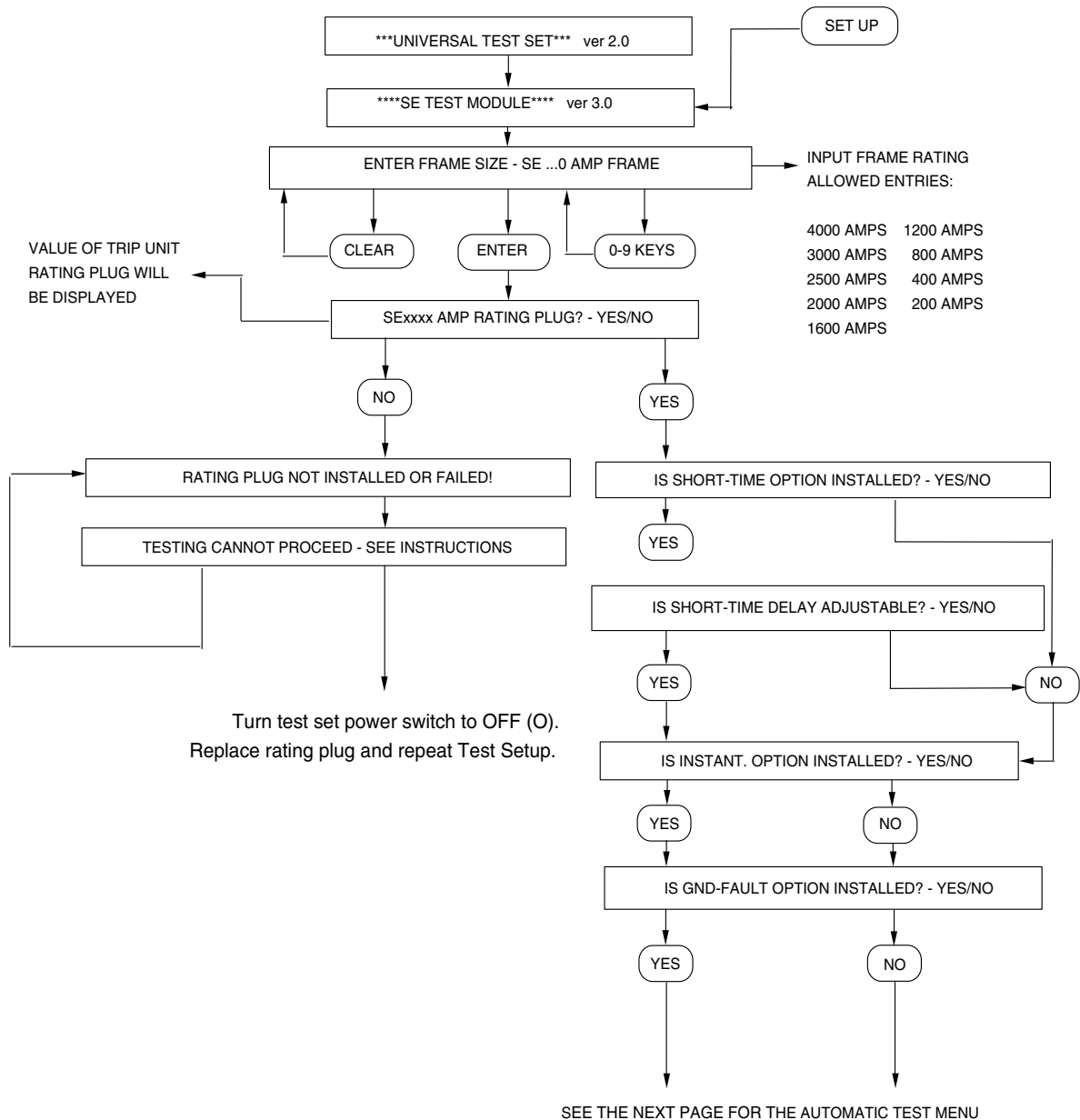

**AUTOMATIC TEST MENU**

05903062

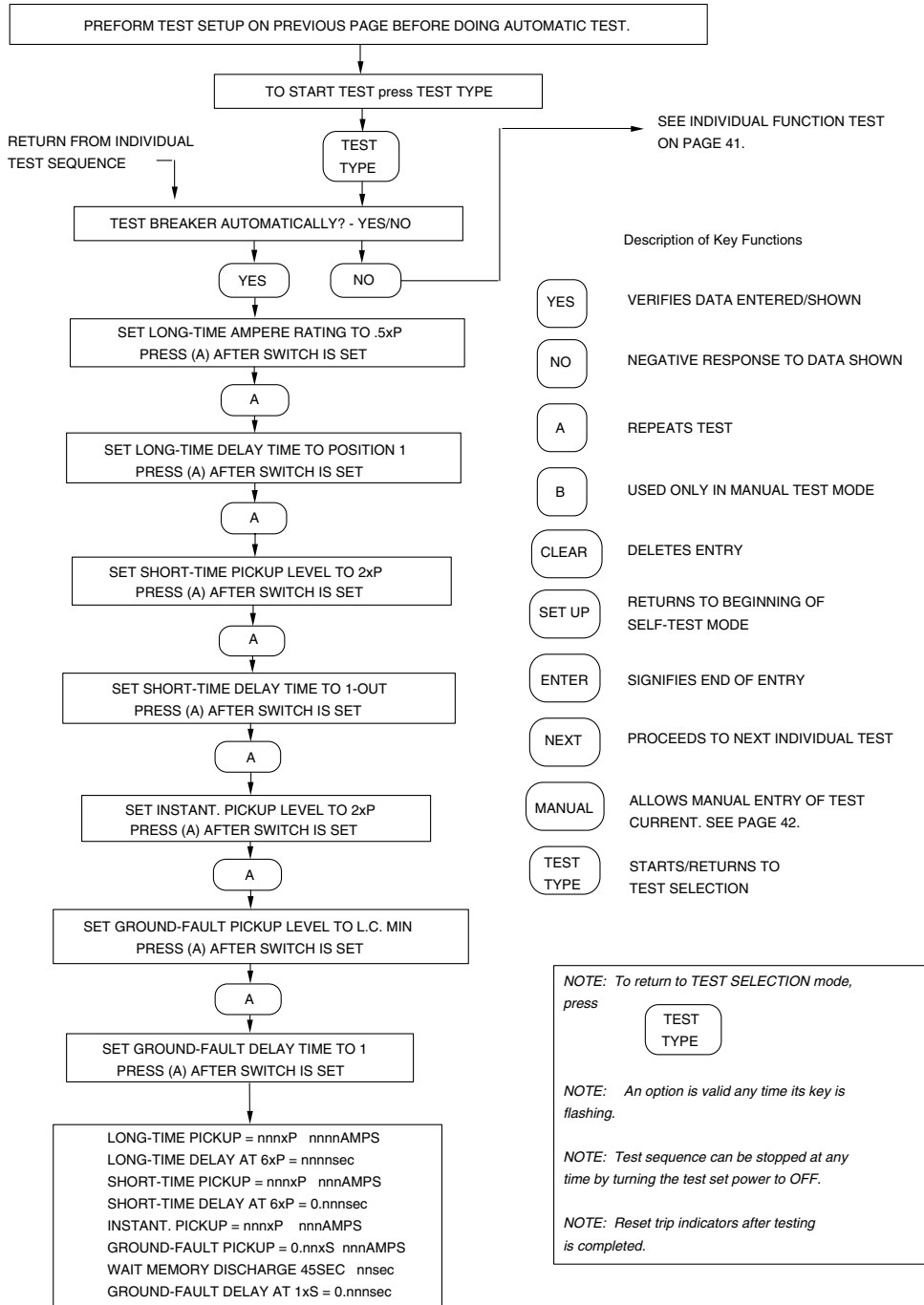



**INDIVIDUAL-FUNCTION TEST MENU**

05903063

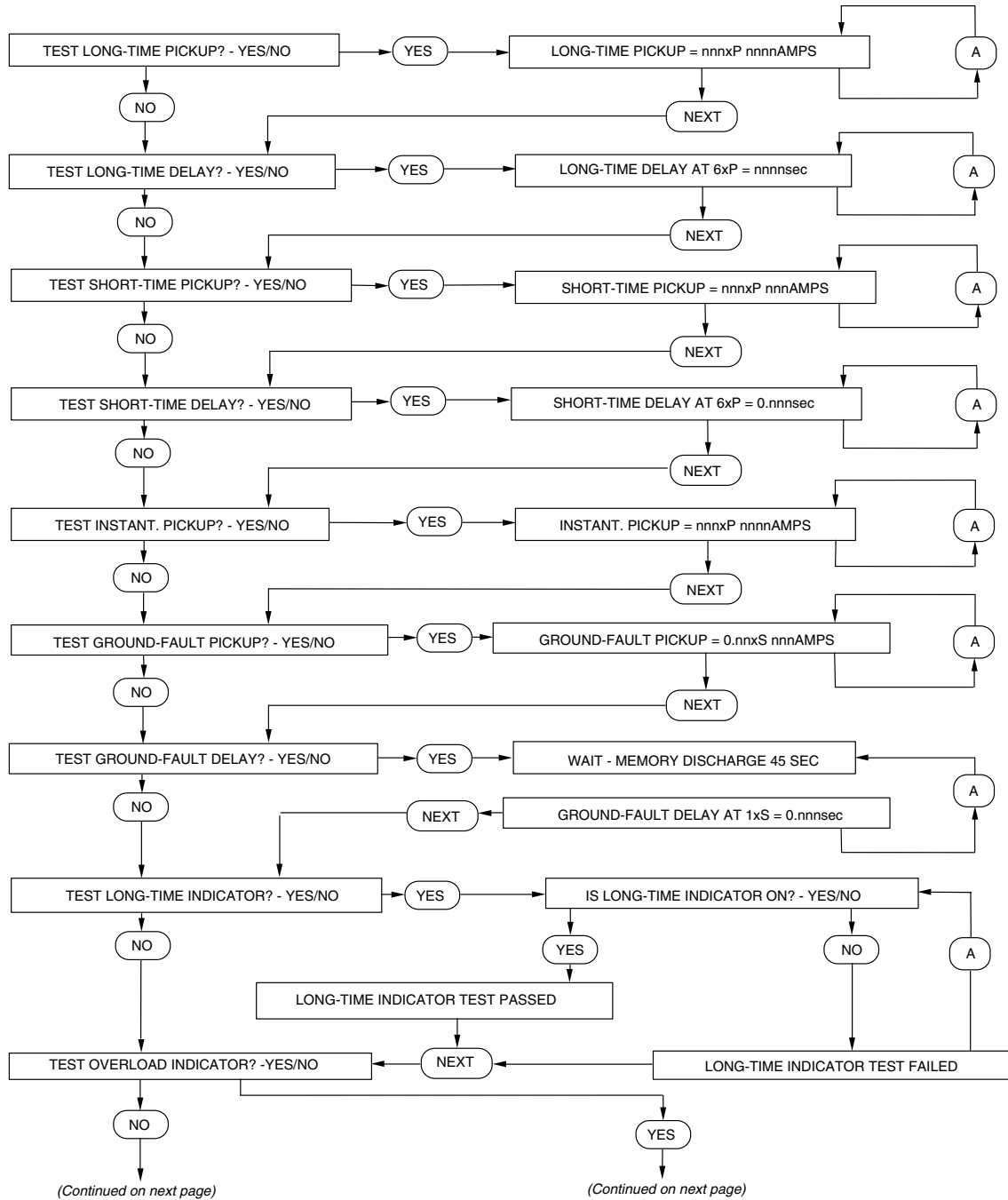

NOTE: To return to TEST SELECTION mode, press

NOTE: An option is valid any time its key is flashing.

NOTE: Test sequence can be stopped at any time by turning the test set power to OFF.

NOTE: If "TEST FAILED" appears on display, press  to repeat test. If "TEST FAILED" appears again, consult with Square D (1-888-778-2733).

**INDIVIDUAL-FUNCTION TEST MENU**

-Continued

05903064

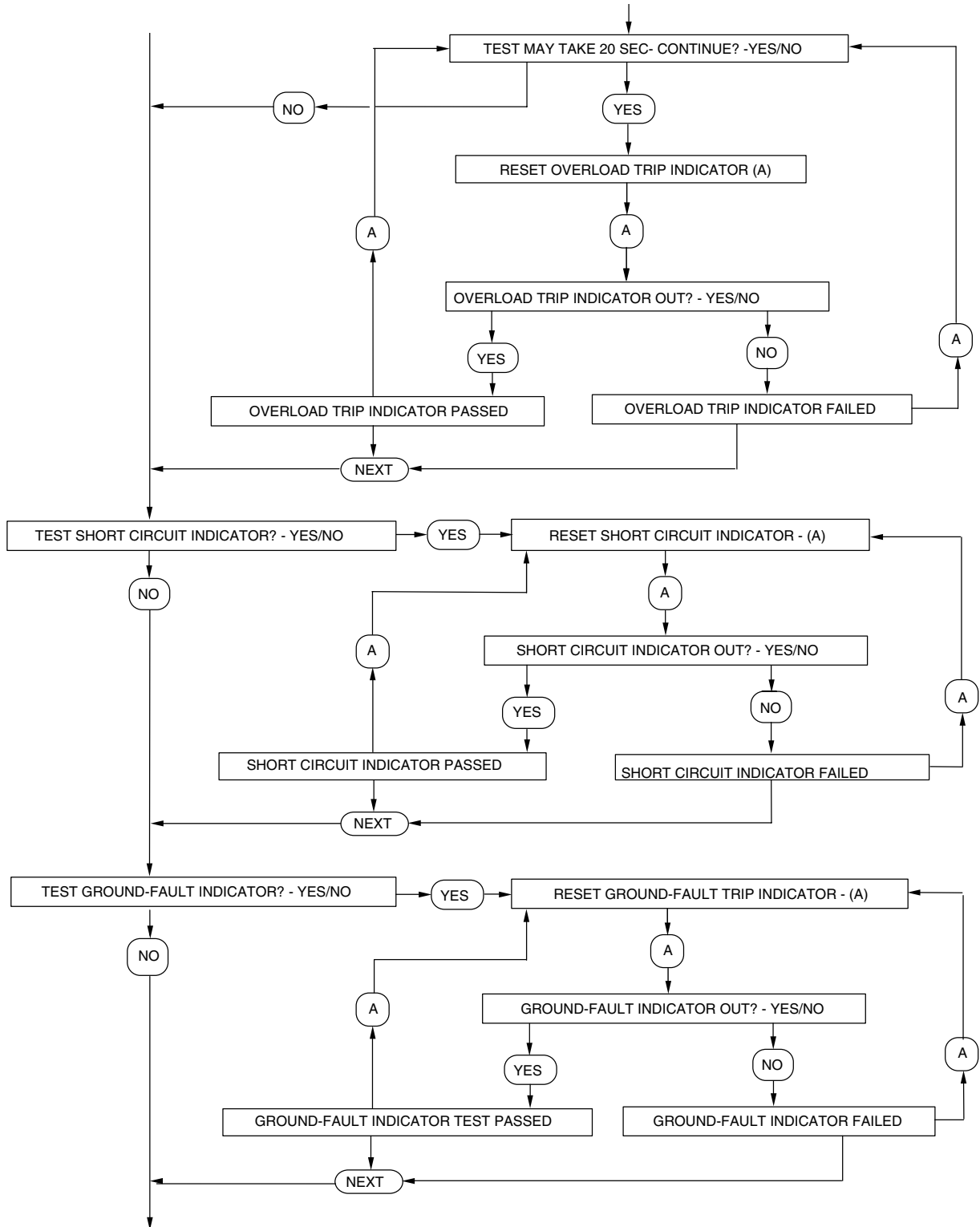

**INDIVIDUAL-FUNCTION TEST MENU**

—Continued

099103085

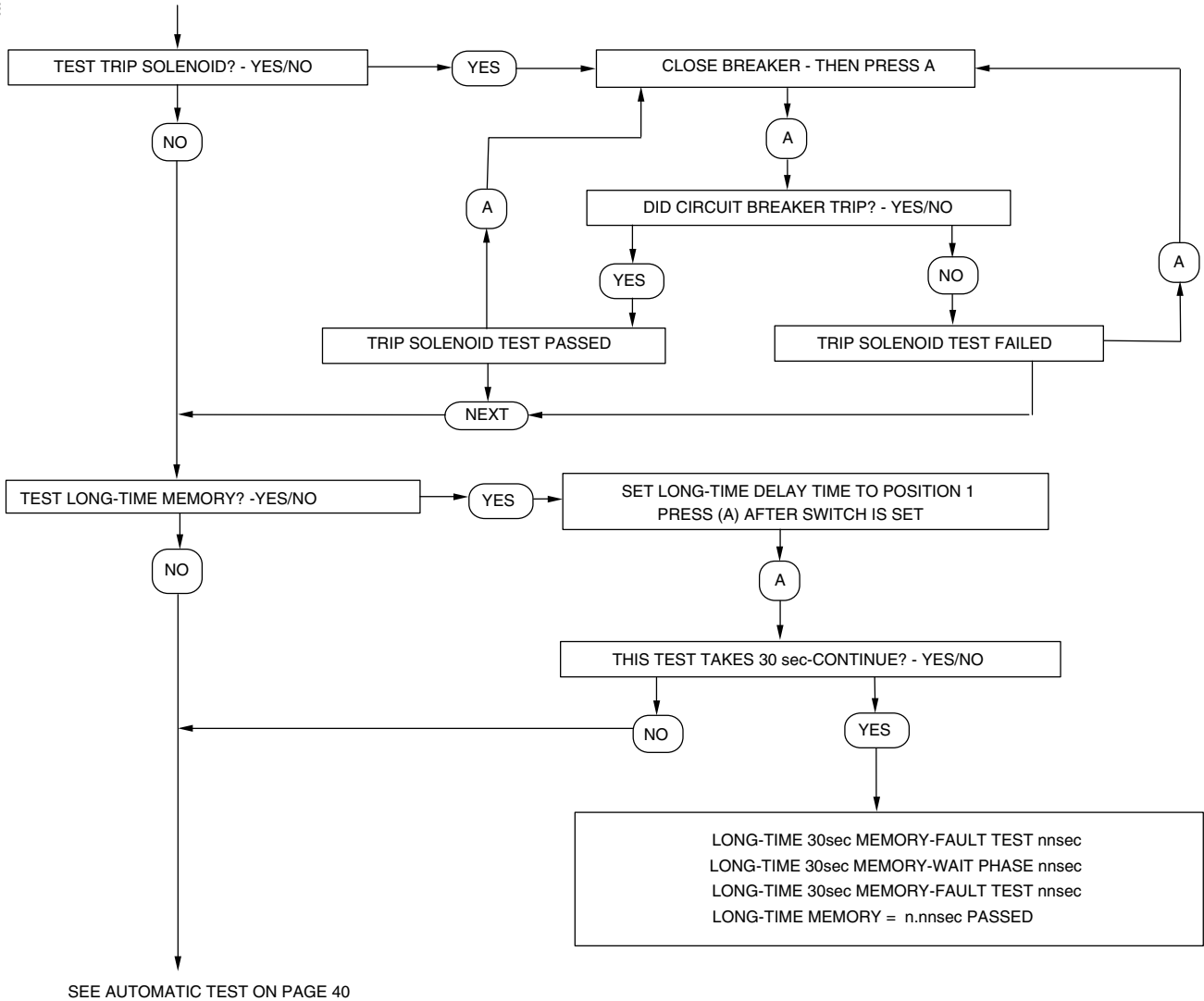

NOTE: To return to TEST SELECTION mode, press **TEST TYPE**

NOTE: An option is valid any time its key is flashing.

NOTE: Test sequence can be stopped at any time by turning the test set power to OFF.

NOTE: Reset trip indicators after testing is completed.

NOTE: If "TEST FAILED" appears on display, press **A** to repeat test. If "TEST FAILED" appears again, consult with Square D (1-888-778-2733).

MANUAL TEST MENU

059M03066

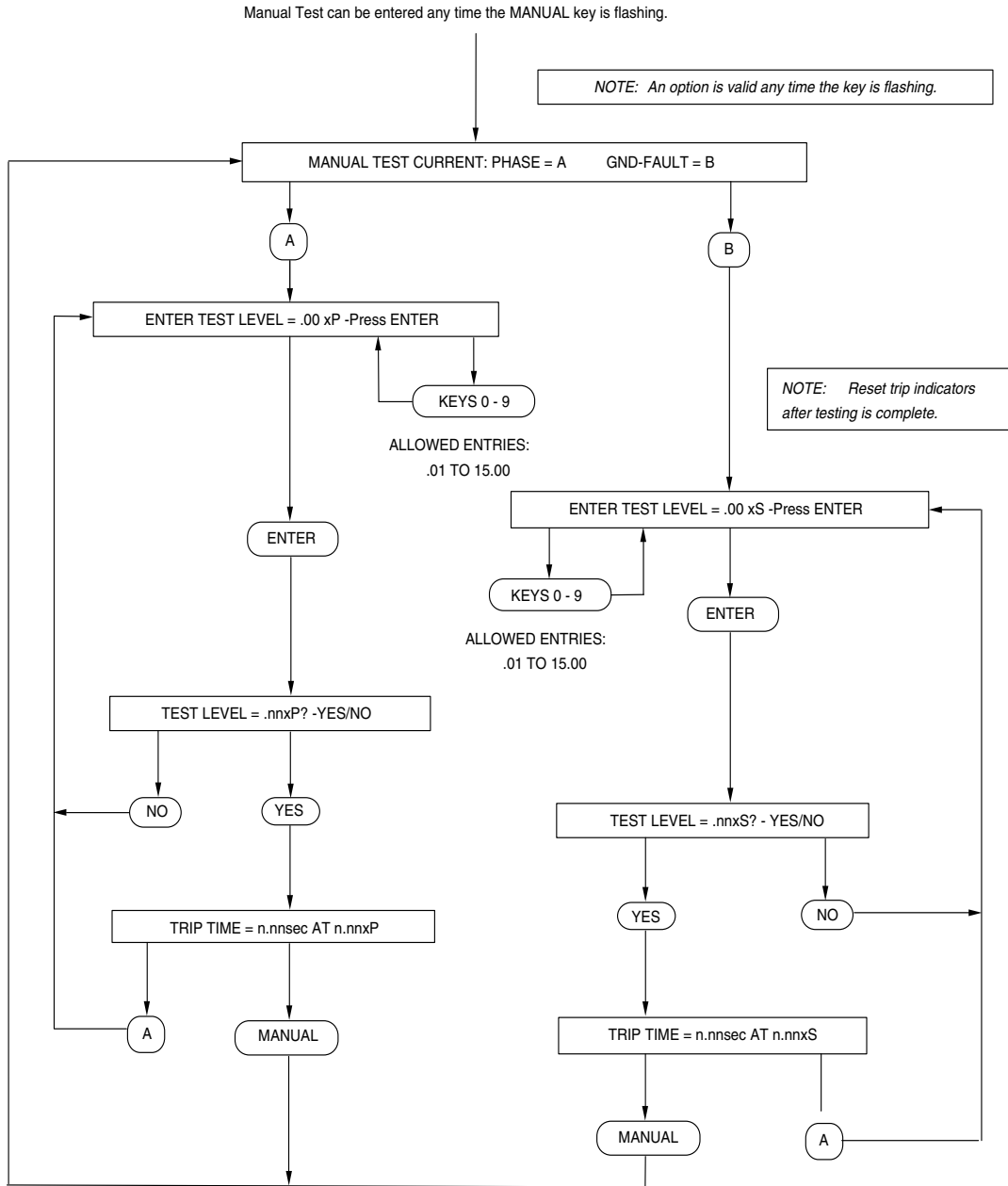

PHASE = Phase current which would be seen at each phase when current is in balance.  
GND-FAULT = Ground-fault current flowing to ground.

NOTE: If current value entered is below the pickup values, the circuit breaker will not trip. The timer will continue to count. To stop the timing function, press MANUAL.

NOTE: To return to TEST SELECTION mode, press **TEST TYPE**

NOTE: Test sequence can be stopped at any time by turning the test set power to OFF.

# Section 7—ME-NE-PE CBTM3 Test Module

## TEST SETUP

09600067

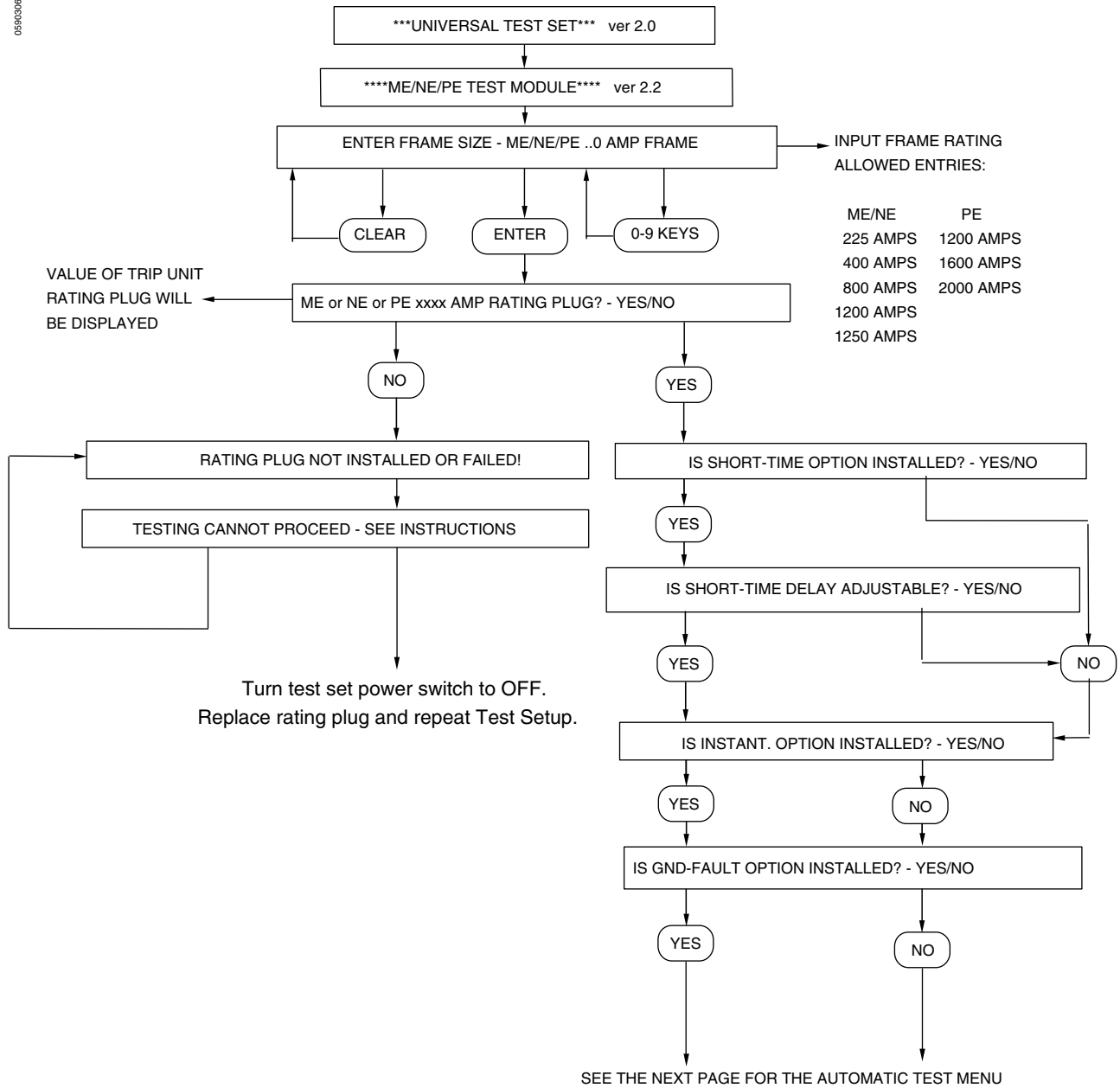

**AUTOMATIC TEST MENU**

05900068

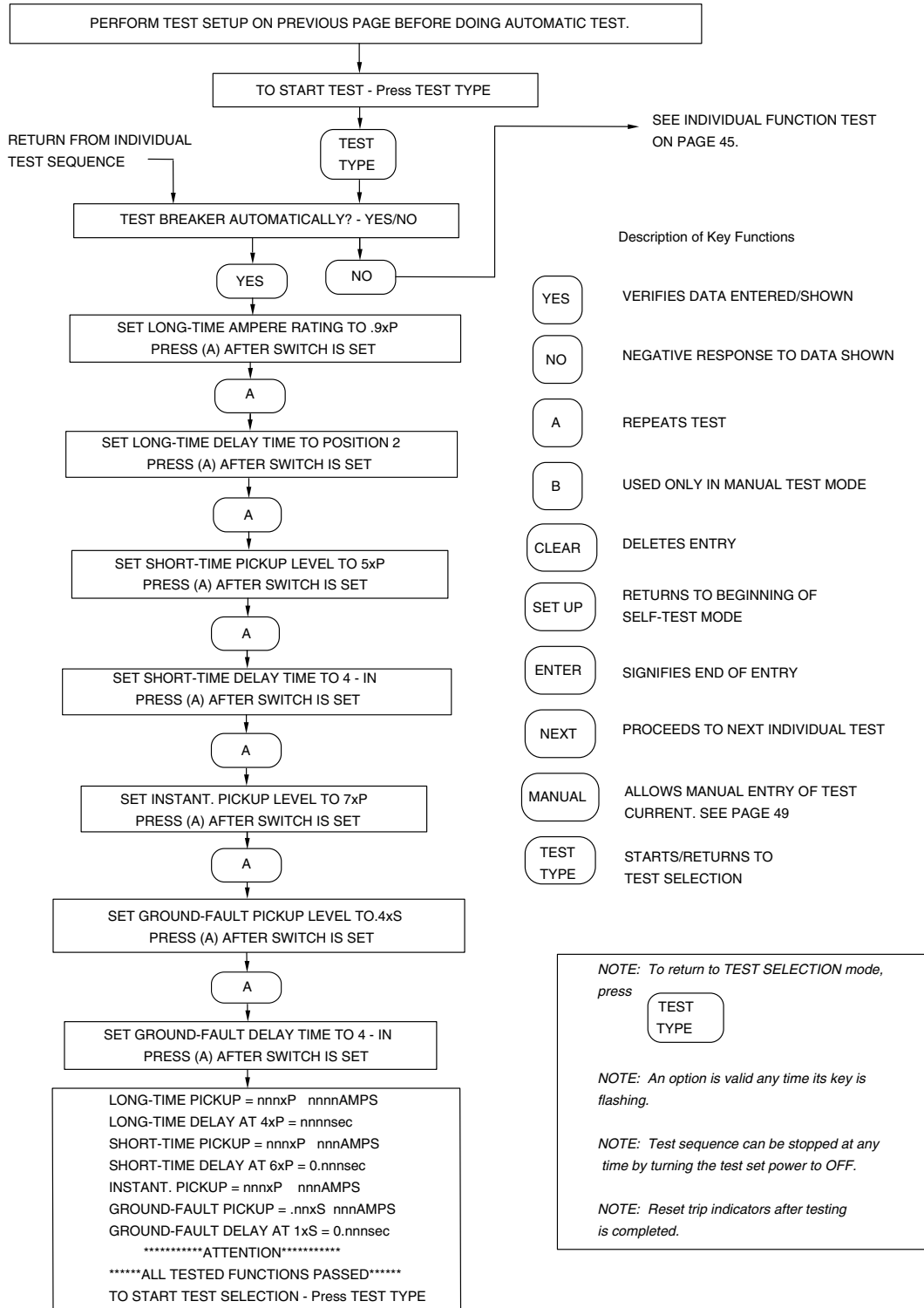

INDIVIDUAL-FUNCTION TEST MENU

05903069

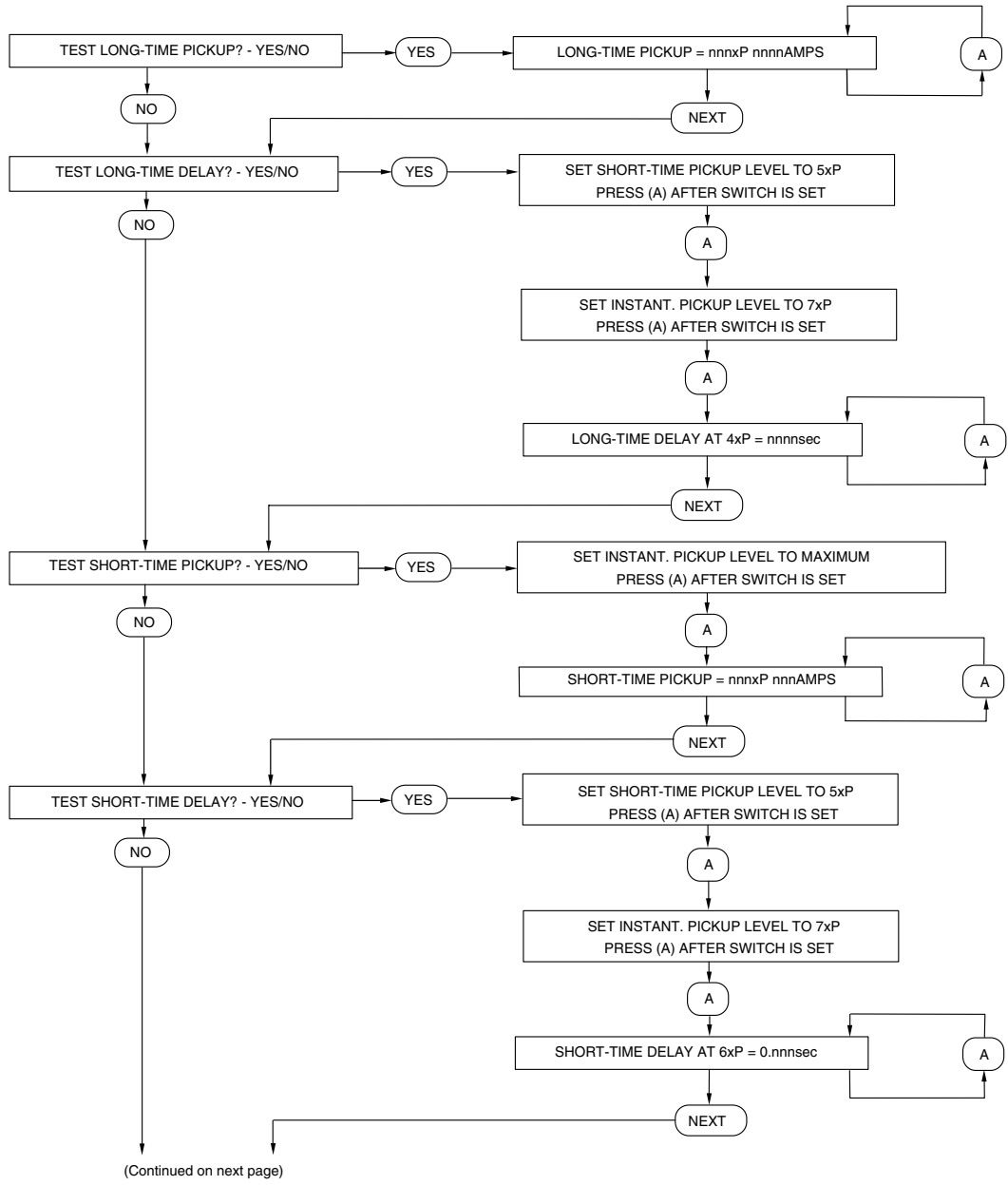

NOTE: To return to TEST SELECTION mode,  
press **TEST**  
TYPE

NOTE: An option is valid any time its key is flashing.

NOTE: Test sequence can be stopped at any time by turning  
the test set power to OFF.

NOTE: If "TEST FAILED" appears on display, press **A** to   
repeat test. If "TEST FAILED" appears again, consult with  
Square D (1-888-778-2733).

**INDIVIDUAL-FUNCTION TEST MENU**

-Continued

05390.3070

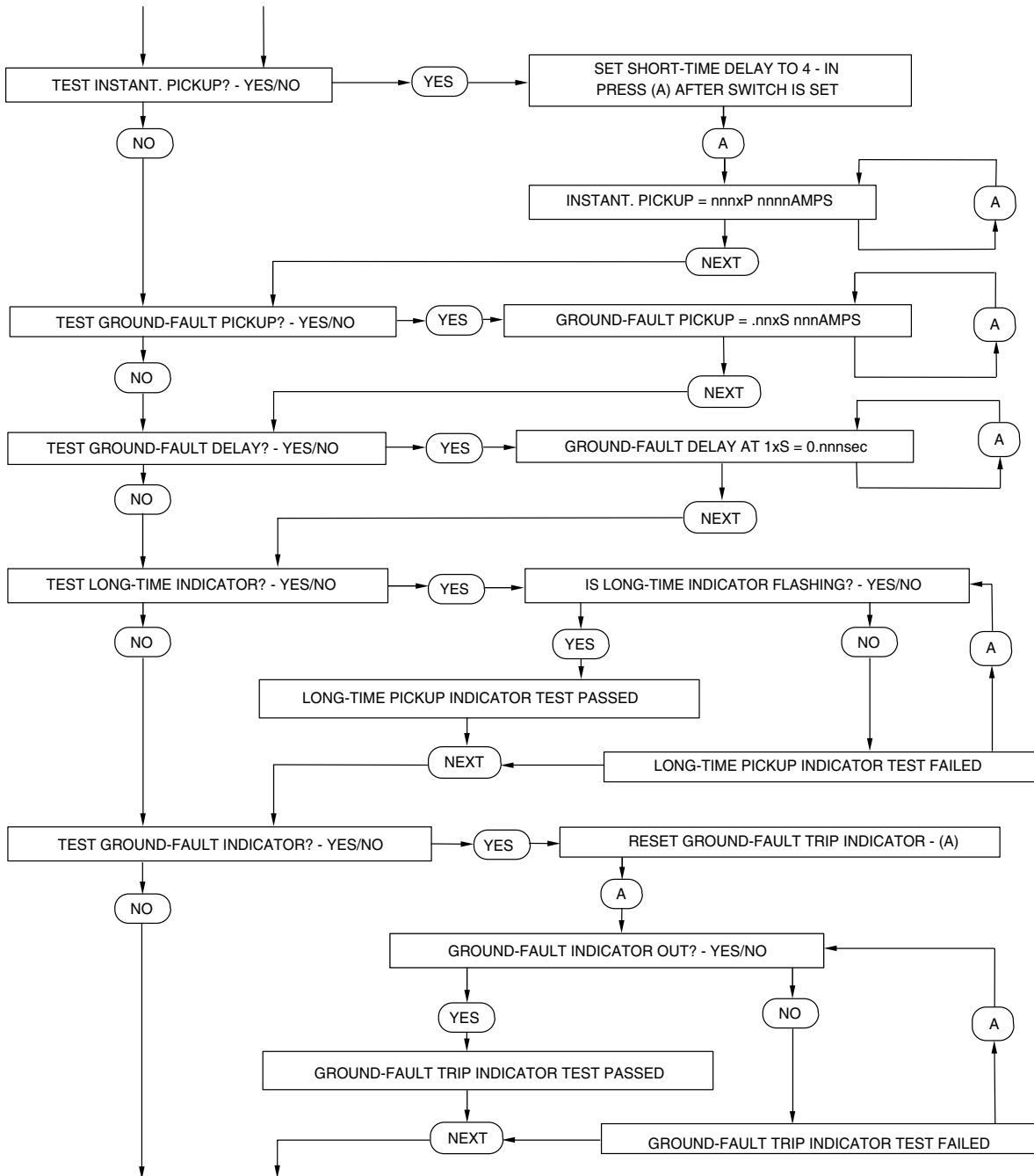

(Continued on next page)



**INDIVIDUAL-FUNCTION TEST MENU**  
—Continued

05/2007/6

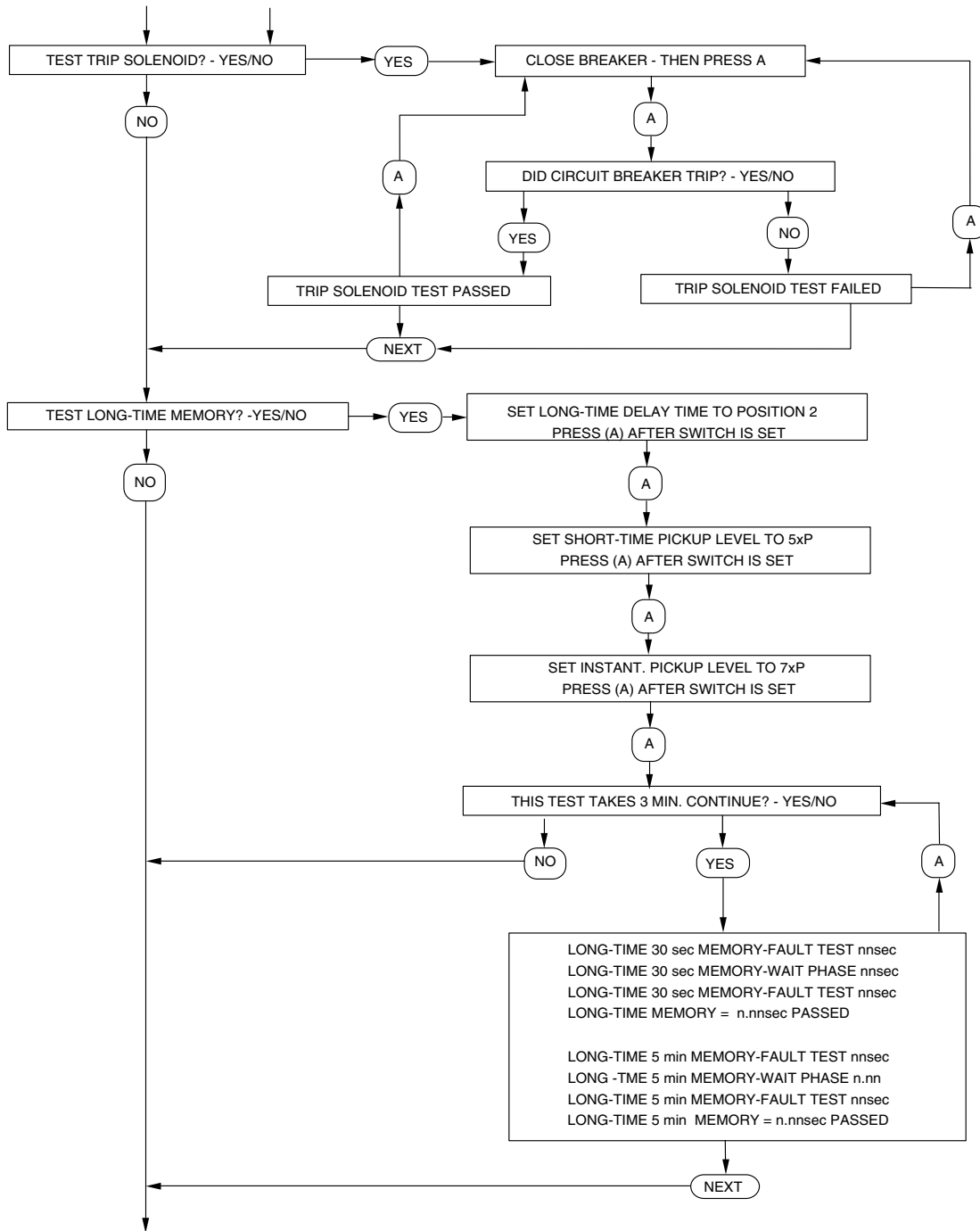

(Continued on next page)

**INDIVIDUAL-FUNCTION TEST MENU**  
-Continued

05903071

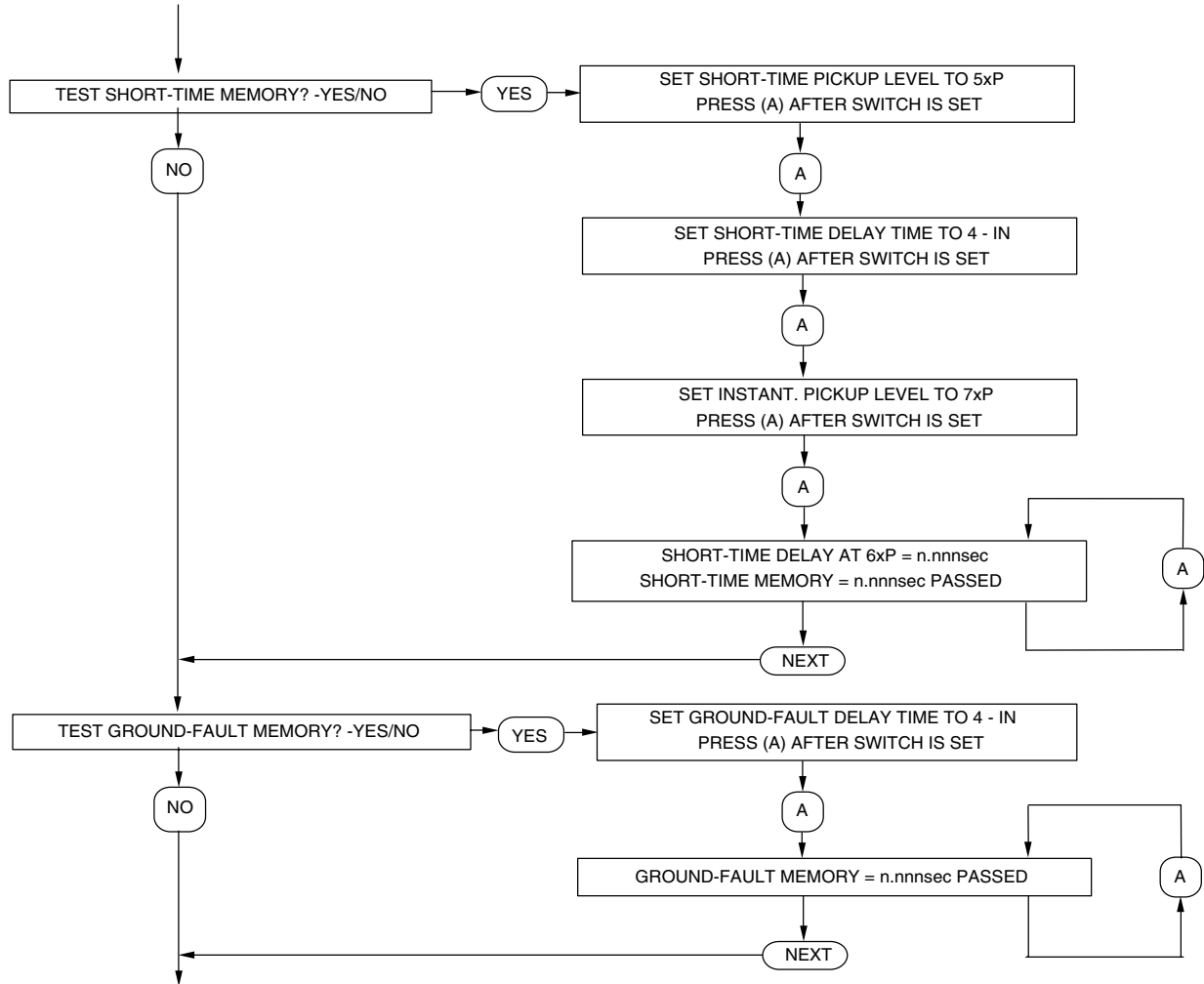

SEE AUTOMATIC TEST ON PAGE 46

NOTE: To return to TEST SELECTION mode, press **TEST TYPE**

NOTE: An option is valid any time its key is flashing.

NOTE: Test sequence can be stopped at any time by turning the test set power to OFF.

NOTE: Reset trip indicators after testing is completed.

NOTE: If "TEST FAILED" appears on display, press **A** to repeat test. If "TEST FAILED" appears again, consult with Square D (1-888-778-2733).

### MANUAL TEST MENU

05903072

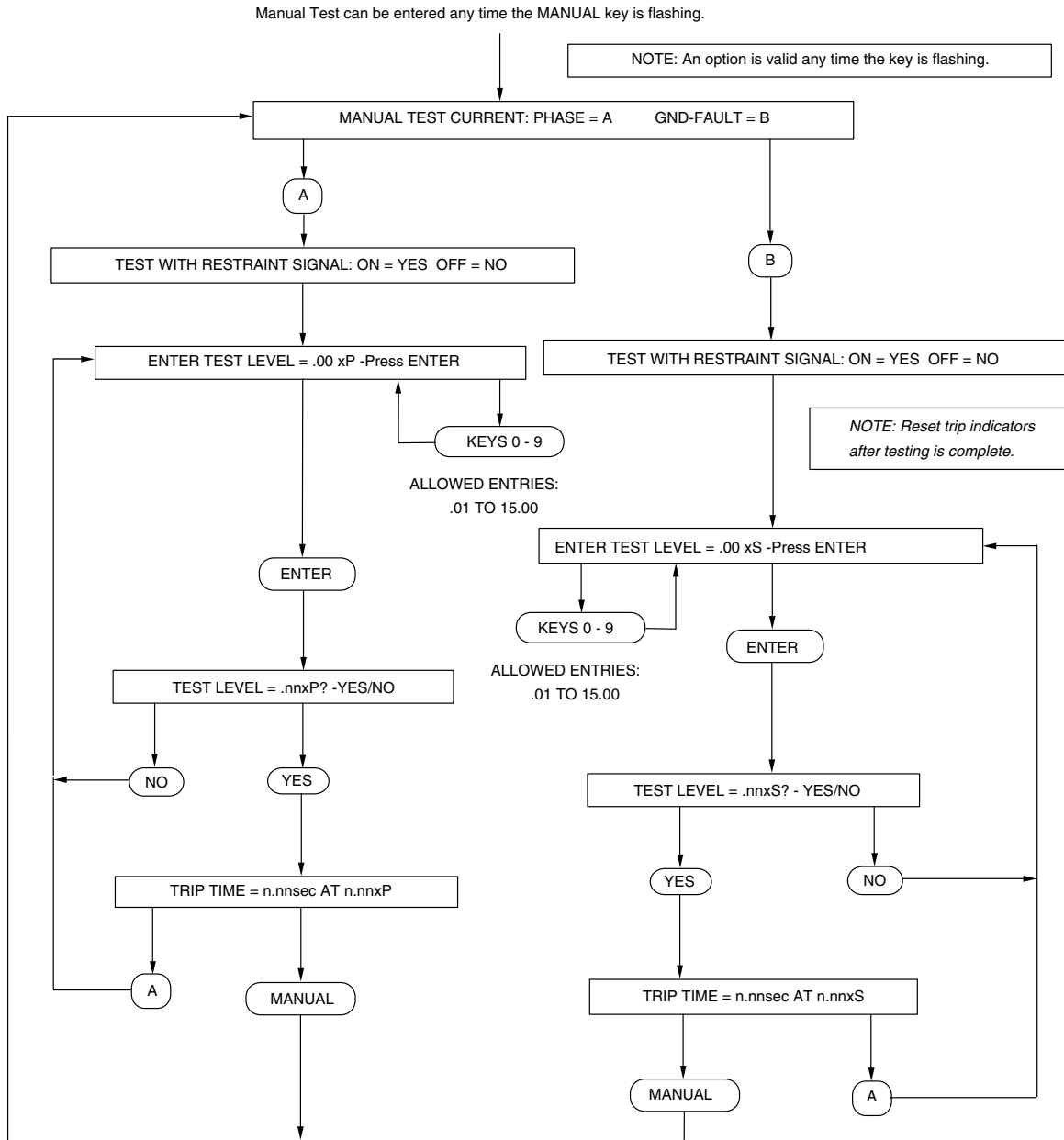

PHASE = Phase current which would be seen at each phase when current is in balance.  
GND-FAULT = Ground-fault current flowing to ground.

NOTE: If current value entered is below the pickup values, the circuit breaker will not trip. The timer will continue to count. To stop the timing function, press MANUAL.

NOTE: To return to TEST SELECTION mode, press **TEST TYPE**

NOTE: Test sequence can be stopped at any time by turning the test set power to OFF.

## Index

### A

Adapter, rating plug .....	12
Applications .....	4
Automatic test menu	
CBTM1 test module .....	40
CBTM3 test module .....	46
CBTM4A test module	
full-function circuit breakers .....	32
standard-function circuit breakers .....	33
CBTMB test module	
circuit breakers with ground-fault alarm ...	19
circuit breakers without ground-fault alarm .....	18
Automatic test mode .....	5

### C

CBTM1 test module .....	39
CBTM3 test module .....	45
CBTM4A test module .....	29
CBTMB test module .....	14

### F

Full-function trip unit	
CBTM4A test module	
test setup .....	29
CBTMB test module	
test setup .....	15

### G

General information .....	4
Ground-fault alarm .....	5
Ground-fault delay .....	5
Ground-fault pickup .....	5

### I

Individual test menu	
CBTM4A test module	
full-function circuit breakers .....	34
standard-function circuit breakers .....	36
CBTMB test module	
full-function circuit breakers with ground-fault alarm .....	22
full-function circuit breakers without ground-fault alarm .....	20
standard-function circuit breakers .....	24
Individual-function test menu	
CBTM1 test module .....	41
CBTM3 test module .....	47
Individual-function test mode .....	6
Interlocking, zone .....	6

### K

Key light tests .....	9
Keyboard tests .....	9

### L

Liquid crystal display test .....	9
Long-time ampere rating .....	5
Long-time delay .....	5
Long-time pickup .....	5

### M

Main test menu	
CBTM4A test module .....	31
CBTMB test module .....	17
Manual test menu	
CBTM1 test module .....	44
CBTM3 test module .....	51
CBTM4A test module	
full-function circuit breakers .....	37
standard-function circuit breakers .....	38
CBTMB test module	
full-function circuit breakers with ground-fault alarm .....	27
full-function circuit breakers without ground-fault alarm .....	26
standard-function circuit breakers .....	28
Manual test mode .....	6
ME-NE-PE CBTM3 test module	
automatic test menu .....	46
individual-function test menu .....	47
manual test menu .....	51
test setup .....	45
MICROLOGIC Series B CBTMB test module	
automatic test menu for all circuit breakers without ground-fault alarm .....	18
automatic test menu for circuit breakers with ground-fault alarm .....	19
individual test menu for full-function circuit breakers with ground-fault alarm .....	22
individual test menu for full-function circuit breakers without ground-fault alarm .....	20
individual test menu for standard-function circuit breakers .....	24
main test menu .....	17
manual test menu for full-function circuit breakers with ground-fault alarm .....	27
manual test menu for full-function circuit breakers without ground-fault alarm .....	26
manual test menu for standard-function circuit breakers .....	28
test module .....	4
test setup .....	14
test setup, full-function .....	15
test setup, standard-function .....	16

M-N-P-S CBTM4A test module		Test module	
automatic test menu for full-function circuit		application .....	4
breakers .....	32	ME-NE-PE CBTM3 .....	45
automatic test menu for standard-function		MICROLOGIC series B CBTMB .....	14
circuit breakers .....	33	M-N-P-S CBTM4A .....	29
individual test menu for full-function		SE CBTM1 .....	39
circuit breakers .....	34	Test set .....	4
individual test menu for standard-function		Test setup	
circuit breakers .....	36	CBTM1 test module .....	39
main test menu .....	31	CBTM3 test module .....	45
manual test menu for full-function		CBTM4A test module	
circuit breakers .....	37	full-function circuit breakers .....	29
manual test menu for standard-function		standard-function circuit breakers .....	30
circuit breakers .....	38	CBTMB test module	
test setup for full-function circuit breakers .....	29	circuit breakers with ground-fault alarm ...	16
test setup for standard-function		circuit breakers without ground-fault	
circuit breakers .....	30	alarm .....	15
		Test types .....	5
<b>P</b>		Test, self .....	8
Power cord .....	4	Trip units	
POWERLOGIC® system .....	7	covers .....	11
Preparation .....	4	rating plug adapters .....	12
		rating plugs .....	11
<b>R</b>		<b>U</b>	
Rating plug adapters .....	13	Umbilical cord .....	4
Rating plugs .....	12		
<b>S</b>		<b>Z</b>	
SE CBTM1 test module		Zone interlocking	
automatic test menu .....	40	LE, ME, NE and PE circuit breakers .....	6
individual-function test menu .....	41	SE circuit breakers .....	6
manual test menu .....	44		
test setup .....	39		
Self-restraint .....	6		
Self-test .....	8		
Series A, B .....	4		
Series, circuit breakers .....	4		
Short-time delay .....	5		
Short-time pickup .....	5		
Standard-function trip unit			
CBTM4A test module			
test setup .....	39		
CBTMB test module			
test setup .....	14		
<b>T</b>			
Terminology .....	5		
Test			
circuit breaker .....	10		
key lights .....	9		
keyboard .....	9		
liquid crystal display .....	9		
self .....	8		
Test modes .....	6		

**Universal Test Set**

Square D Company  
PO Box 3069  
3700 Sixth St SW  
Cedar Rapids IA 52406-3069 USA  
1-888-SquareD (1-888-778-2733)  
[www.SquareD.com](http://www.SquareD.com)

Electrical equipment should be serviced only by qualified personnel. No responsibility is assumed by Schneider Electric for any consequences arising out of the use of this material.

Bulletin No.4804097602 March 2001 Replaces 4804097602 dated 12/93.