



CX150-D3+
CX180-D3+
DOCSIS 3.0
CATV Analyzer

VePAL CATV Analyzers

CX100+ **CX150+** **CX150-D3+**
CX110+ **CX180+** **CX180-D3+**
CX120+



CATV and DOCSIS network testing simplified

VeEX™ VePAL CATV analyzers are next generation test solutions designed for analog and digital cable TV networks supporting VoIP and Internet service.

Platform Highlights

- Intuitive presentation of measurements with test graphics
- High resolution color touch-screen viewable in any lighting conditions fitted with protective cover
- Robust, handheld chassis packed with powerful and flexible features for demanding environments and test conditions
- Optimized for field engineers or technicians installing and maintaining CATV networks enabling triple play services
- Ethernet port and connection for back office applications, workforce management and triple play service verification
- USB memory stick, Bluetooth adaptor, and FTP upload capability for test result storage and file transfer respectively
- Maintain instrument software, manage test configurations, process measurement results and generate customer test reports using included ReVeal™ PC software
- Extend field testing time using interchangeable Lilon battery pack/s. Greater battery autonomy provided in standby mode
- Supports advanced IP testing; Ping, trace route, ARP Wiz, VoIP, IPTV, WiFi, Web browser, and FTP upload/download via Ethernet or USB port where applicable
- Perform remote testing and monitoring using the remote control option via standard Ethernet interface
- NetWiz cable diagnosis with network statistics*
- VoIP call emulation and MOS performance analysis*
- WiFi Wiz site survey with Internet and VoIP check*

Key Features

- Frequency analysis from 5 to 1000 MHz
- Supports Annex A and B signal formats
- Comprehensive SLM features including single channel measurement, system scan, tilt, and installation check
- Measure power level of NTSC, PAL and SECAM video signals
- Carrier-to-Noise (C/N); Adjacent Channel measurement ratio
- MER and Pre/Post BER measurements of QAM carriers with Constellation diagram and Histogram
- Forward and Reverse path ingress scan to detect noise and/or CSO/CTB interference
- Reverse Path QAM 16/64/128 MER, Pre/Post BER measurement with Constellation diagram (CX180+)*
- Equalized/unequalized MER and BER measurements (CX180+)
- DOCSIS 2.0/EuroDOCSIS 2.0 modem emulation with USG capability (CX150+/optional on CX180+)
- DOCSIS 3.0/EuroDOCSIS 3.0 modem emulation (CX150-D3+/CX180-D3+)
- Cable Modem Upgrading check (CX110+)
- Upstream Signal Generator (USG) (CX150+/optional on CX180+)
- Upstream QAM 16/64/128, CW, QPSK signal generation with FEC (CX120+/CX180+)*
- RP Balancing* for loopback testing (with CX120+/CX150+/CX180+)
- Home Installation Process*

*Optional

Applications

VeEX™ VePAL CX instruments are next generation test solutions to install and maintain analog and digital cable TV networks offering Triple Play services. All CX products are lightweight, rugged and weather resistant and feature signal level meter capabilities. Certain models can be equipped with a cable modem option to validate DOCSIS and Euro DOCSIS based networks while some units can be equipped with an Upstream Signal Generator to support QAM signal generation for reverse path QAM analysis.

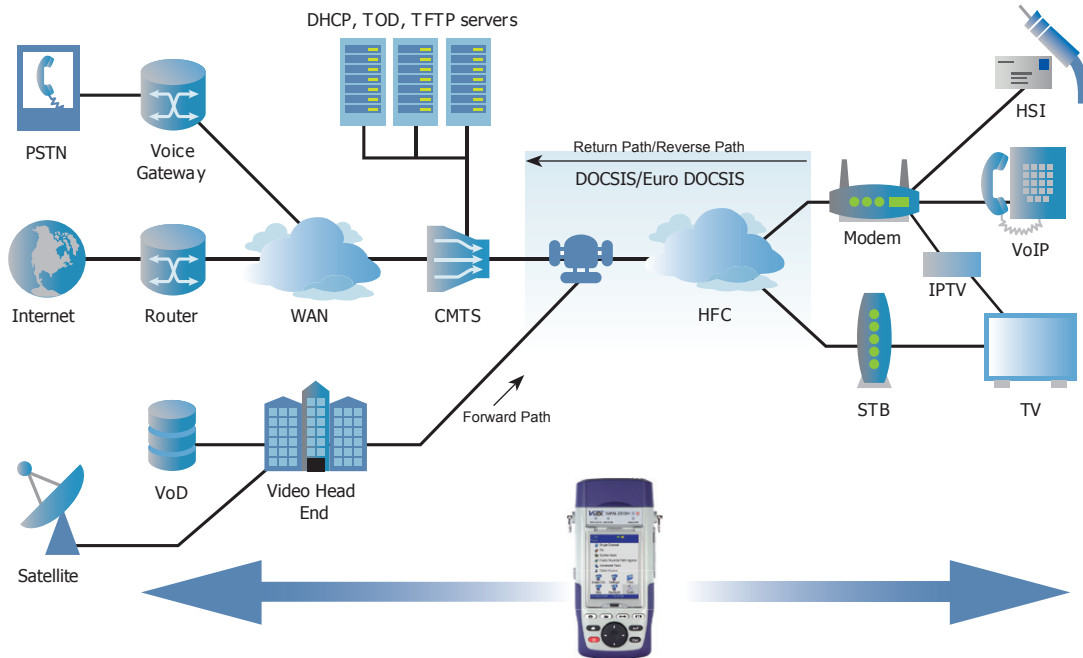

CX Series Feature Comparison

Cable Expert Features	CX100+	CX110+	CX120+	CX150+	CX180+	CX150-D3+	CX180-D3+	
Analog Channel Measurement	✓	✓	✓	✓	✓	✓	✓	
Digital Channel Measurement	✓	✓	✓	✓	✓	✓	✓	
Constellation Diagram	✓	✓	✓	✓	✓	✓	✓	
Digital Channel Deep Interleave	✓	✓	✓	✓	✓	✓	✓	
Installation Check	✓	✓	✓	✓	✓	✓	✓	
Full System Scan	✓	✓	✓	✓	✓	✓	✓	
Forward/Reverse Path Ingress Scan	✓	✓	✓	✓	✓	✓	✓	
Upstream Signal Generator	✗	✗	✗	✓	⊕	✓	✓	
Upstream Signal Generator with FEC coding	✗	✗	⊕	✗	⊕	✗	✗	
Home Installation Process	⊕	⊕	⊕	⊕	⊕	⊕	⊕	
Return Path Balancing	✗	✗	⊕	⊕	⊕	⊕	⊕	
DOCSIS 2.0 Cable Modem Emulation	✗	✗	✗	✓	⊕	✓	✓	
DOCSIS 3.0 Cable Modem Emulation	✗	✗	✗	✗	✗	✓	✓	
Cable Modem Upgrading Test	✗	✓	✗	✓	⊕	✓	✓	
Reverse Path QAM Analysis	✗	✓	✗	✗	⊕	✗	⊕	
Equalized and Un-equalized MER	✗	✗	✗	✗	✓	✗	✓	
TDR	✗	✗	⊕	✗	✗	✗	✗	
IP Test Suite via Cable Modem Port								
Basic Ping	✗	✗	✗	✓	⊕	⊕	⊕	
VoIP	✗	✗	✗	⊕	⊕	⊕	⊕	
IPTV	✗	✗	✗	⊕	⊕	⊕	⊕	
Trace Route, ARP, Web/FTP, Web Browser	✗	✗	✗	⊕	⊕	⊕	⊕	
IP Test Suite via Chassis ports								
	10/100-T or USB				10/100/1000-T or USB			
Basic Ping	✓	✓	✓	✓	✓	✓	✓	
IPTV	⊕	⊕	⊕	⊕	⊕	⊕	⊕	
VoIP	⊕	⊕	⊕	⊕	⊕	⊕	⊕	
Trace Route, ARP, Web/FTP, Web Browser	⊕	⊕	⊕	⊕	⊕	⊕	⊕	
Net Wiz	⊕	⊕	⊕	⊕	⊕	⊕	⊕	
WiFi Wiz	⊕	⊕	⊕	⊕	⊕	⊕	⊕	
File Transfer								
ReVeal R300 Software Management Tool	✓	✓	✓	✓	✓	✓	✓	
via LAN Management Port	✓	✓	✓	✓	✓	✓	✓	
via Cable Modem Port	✗	✗	✗	✓	⊕	✓	✓	
USB Memory Stick, Bluetooth, FTP File Transfer	✓	✓	✓	✓	✓	✓	✓	

Legend: ✓ Standard feature ⊕ Optional feature ✗ Not supported

Features

Single Channel Measurement

Analog and digital carriers are very different in terms of signal content and power distribution and thus require the advanced SLM techniques supported in the VePAL CX series.

In **analog** mode, video and audio levels, V/A, Carrier to Noise (C/N) and Adjacent channels are measured. In **digital** mode, average power, MER, Pre-BER, Post-BER, Error seconds, and constellation diagram are displayed. User programmable location thresholds and test point compensation are useful utilities enabling fast, simple and automated testing of carrier signals.

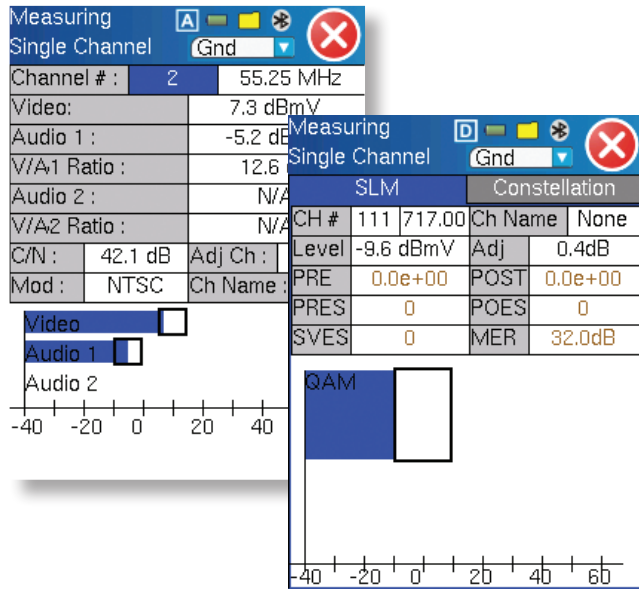

Digital pictures do not show signal impairment until it is too late because the margin between acceptable quality and failure is quite small.

Constellation diagrams are a valuable tool to help detect the presence of noise, phase jitter, interference and gain compression, all of which impact overall signal quality and thus reduces Modulation Error Ratio (MER). Ideally, each of the 64 or 256 symbols should display a clean dot indicating a perfect QAM signal. Therefore, the size and shape build up of dots is indicative of problems which contribute to bit errors and even service disruption.

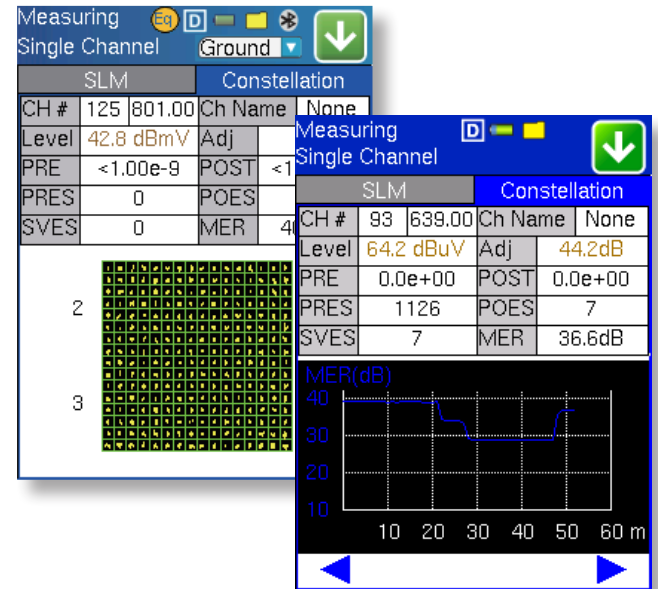

Installation Check

For new installations, up to 12 analog and 12 digital channels are checked against preset location thresholds. The feature is particularly useful to verify and turn up of service at new installations or after service is restored, Pass and fail conditions are color coded for easy interpretation and test results are clearly displayed. This automatic test procedure adds consistency to the final service qualification. A zoom function provides data measurement in greater detail. The VePAL CX series can store up to 20 channel tables each of which can be pre-programmed with channels to be used for installation check.

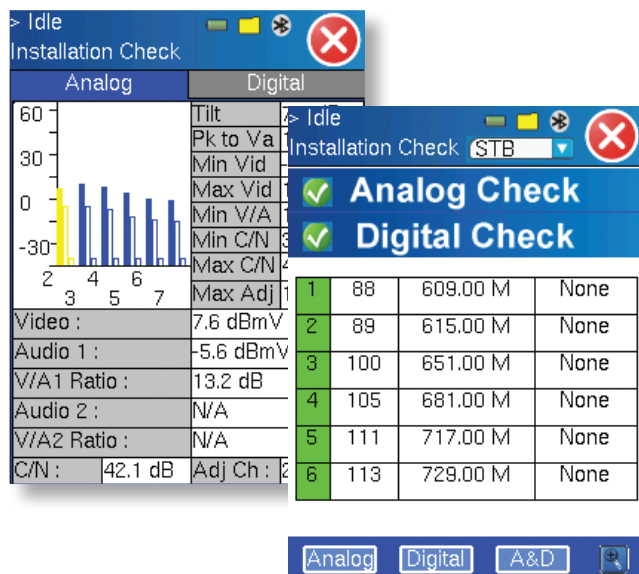

Tilt

Tilt measurements identify distortion over the frequency range allowing technicians to apply correct equalization or compensation to the HFC network. Up to six analog signals and digital carriers including DOCSIS channels can be predefined on a channel table and selected to perform the tilt measurement. The measurement can be performed between the lowest and highest channel or any user selectable channel by tapping the applicable bar on screen.

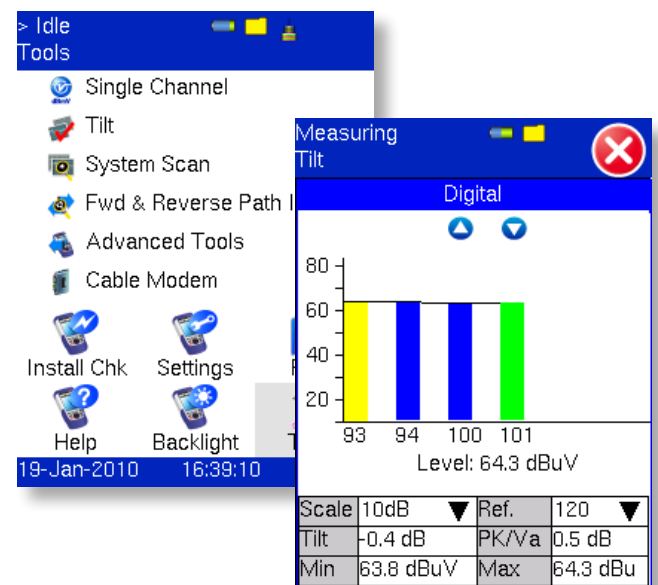

System Scan

Within seconds, all analog and digital channels at a service location are measured. Signal parameters including channel number, channel name, frequency, modulation type and power levels are measured.

Signal degradation or tilt can be easily pinpointed using on-screen markers and the zoom mode.

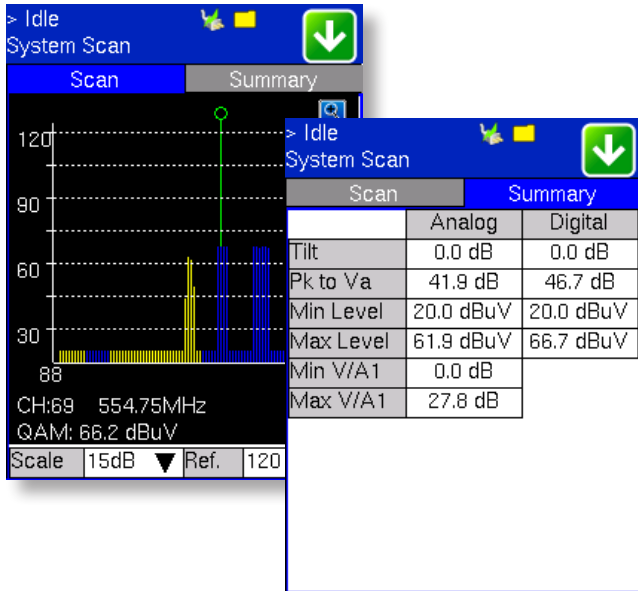

Forward/Reverse Path Ingress Scan

Poorly shielded coaxial cable and fault terminations (CPD) are sources and causes of ingress noise. Ingress is troublesome for return path communications in CATV networks due to the large number of subscriber-generated signals being funneled towards the headend. The combined and amplified interference is often responsible for service disruption, therefore the ingress test is a valuable tool to check the forward and reverse paths for interference and related problems.

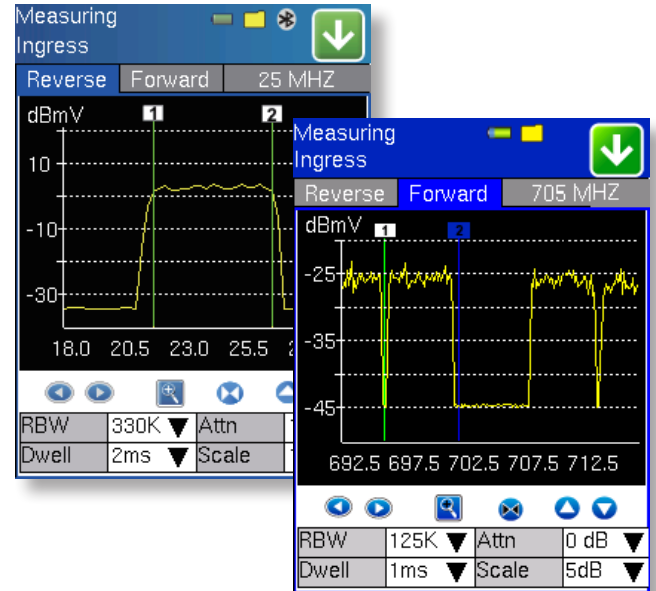

Reverse Path QAM Analysis (CX180+ and CX180-D3+)

Reverse Path digital QAM signal is carefully analyzed for the QAM level, MER, pre and post BER, and error seconds. The Upstream Signal Generator in the CX120+ and CX180+ series can be used to generate the QAM-16/64/128 signal from a distant location for detailed analysis.

Adaptive Equalization – Modern Cable Modems, Set-Top Boxes and Cable Modem Termination Systems (CMTS) use advanced Adaptive Equalizer technology to compensate for complex in-channel frequency response impairments caused by micro-reflections, amplitude ripple and group delay occurring in the network. An adaptive equalizer adjusts its characteristics based on a single digitally modulated QAM carrier only as channel conditions change. This process maximizes or greatly improves the MER in the forward or reverse path.

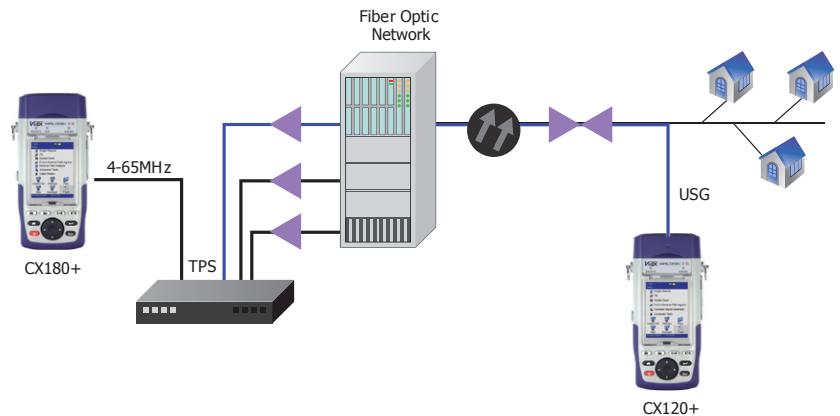

Equalized and Unequalized MER – Unequalized MER is typically measured before the adaptive equalizer and equalized MER is measured after the adapter equalizer, but often this circuitry resides in the QAM receiver and cannot be disabled. So while the adaptive equalizer does a great job improving MER of a QAM signal, it is also important for technicians to know how hard the system is working to ensure adequate margin for system degradation. The adaptive equalizer in the unit can be turned off to make troubleshooting marginal amplifiers, ingress, CPD and related impairments easier. In addition, Histograms for Level, MER, Pre/Post FEC, Pre/Post ES/SES/SVES help monitor problems over a period of time.

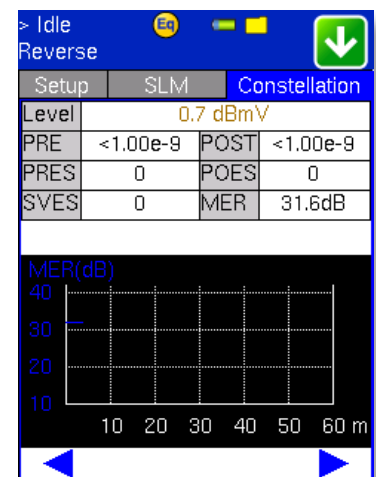
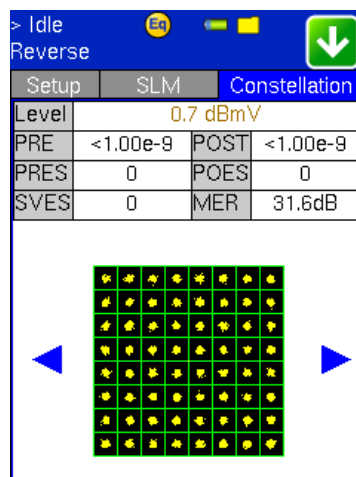

Upstream Signal Generator

Assessing the bandwidth characteristics of the reverse path used for the DOCSIS upstream communications has become vitally important. Transmitting a signal into the reverse path at a desired frequency, level, modulation type and symbol rate, allows the technician to evaluate phase and amplitude distortions resulting from misalignment occurring in the network. In particular, injected signals can also be used to determine if amplifier laser clipping occurs due to overloading. When used in conjunction with a QAM CATV spectrum analyzer, MER and related parameters can be assessed.

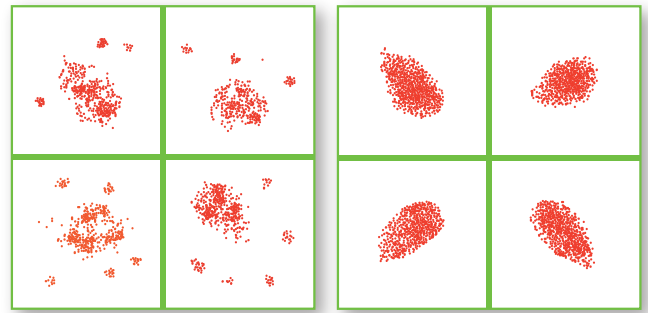

Constellation with bit errors

Constellation with laser clipping

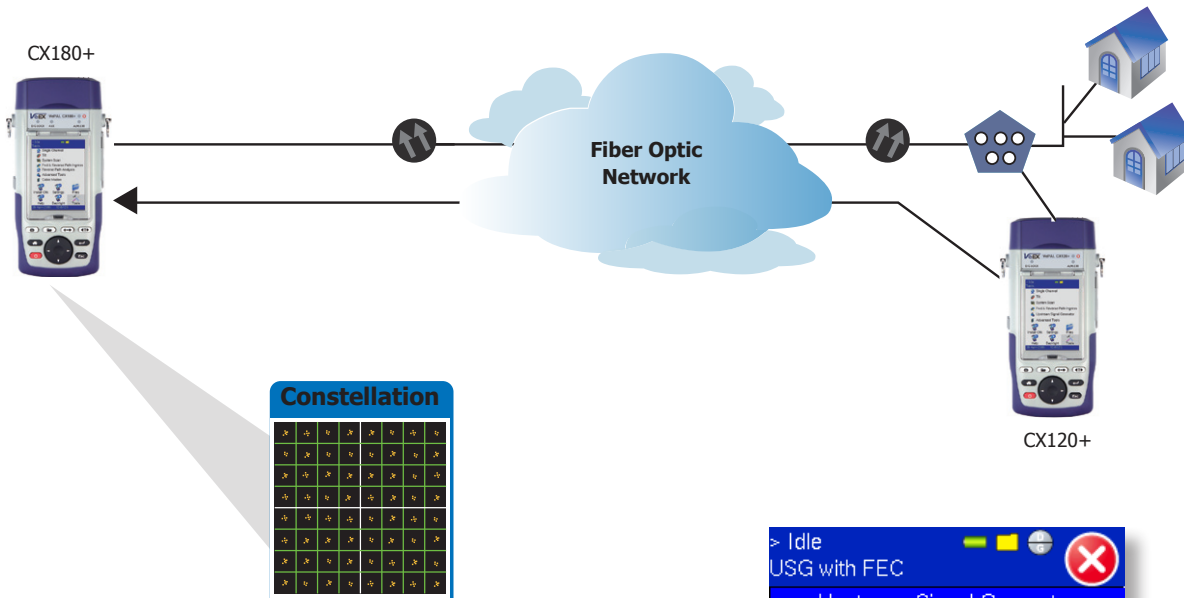

USG with FEC (CX120+/CX180+)

The CX120+ transmits a reference signal of 5-65MHz (Annex A) or 5-42MHz (Annex B) to characterize the upstream. A choice of CW, QPSK, 16QAM, 64QAM and 128QAM modulation types with pre-defined symbol rates emulates DOCSIS cable modem transmission. Adjustable power level is useful to check amplifier performance resulting from overloading while FEC encoding enables a companion instrument like CX180+ to perform advanced digital measurements including MER, Pre/Post FEC, EVM, Phase jitter and related parameters.

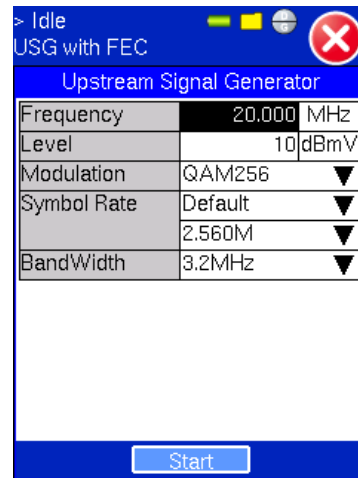

RP Balancing

Return Path (RP) balancing is an alignment test for upstream amplifiers. The SLM and USG functions on selected CX models work in tandem to evaluate and align an amplifier's performance as a function of frequency. Programmable single tone, dual tone, or sweep through the entire return path spectrum is possible.

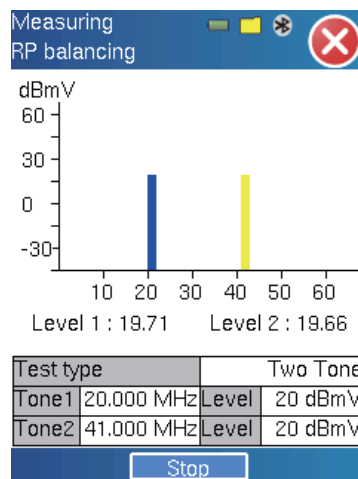

DOCSIS® 2.0/EuroDOCSIS 2.0 Cable Modem Emulation (CX150+/CX180+)

The built-in DOCSIS/EuroDOCSIS cable modem provides a fast and reliable method to check Internet connectivity and test Triple Play services over the RF interface.

Simple Setup and Connection Summary

Technicians can test according to defined channel plans using default settings or the Media Access Controller (MAC) address and channel details can be configured manually as required. The modem ranges and connects with the Cable Modem Termination System (CMTS) and registers with various servers on the network, recording the entire process. A summary of the key Downstream and Upstream parameters including frequency, power level, UCD selection and IP server status are displayed so technicians can view problems quickly without spending valuable time scrolling through multiple test results and screens.

Setup	Results	IP	Link	Events	
Channel	Manual	R-Serv	Web/FTP	IPTV	VOIP
	93	639.00			
MAC Add	Default				
	00-1c-7b-2d				
Version	87.7.2.354.00				
Model	CX				
Annex	Annex B				
Test Mode	Terminate				
		Downstream Freq	639.00 MHz		
		Downstream Lock	PASS		
		Upstream Sync	UCD 1		
		Downstream Sync	4.50 dBmV		
		Upstream Ranging	36.75 dBmV		
		DHCP	PASS		
		Time Of Day	PASS		
		TFTP	PASS		
		Configuration File	PASS		
		Registration	PASS		
		Connection	Online		

Downstream/Upstream Results

Downstream Power including the Signal-to-Noise Ratio (SNR) is measured, because too much noise on the cable results in data errors, even when received power level is within limits. During upranging, the modem's Transmit Power is adjusted in fine increments to the point where the CMTS receives the same signal level from all modems on a particular upstream channel irrespective of different cable losses. For technicians, the upranging power level is indicative of return path quality.

Downstream	Upstream		
Frequency	639000	Frequency	29000000 Hz
Width	6000	Power	36.75 dBmV
Modulation	25	Symbol Rate	5120000 sym/sec
Interleave	12	Minislot Rate	32 symbols
Power	4.10		1 ticks
Symbol Rate	5360537 sym/sec	Channel Type	ATDMA
		Modulation	64QAM

Registration Procedure

The vast majority of non-RF problems encountered in the field are IP-related, so it is very important for the technician to have a good insight to the registration process and IP connection status to various servers implemented in the network.

Once a communication link has been established with the CMTS, the modem obtains an IP address and the configuration file name from the DHCP server, including IP addresses of other important servers present on the network. If the modem is not provisioned on the network correctly, the DHCP process will fail forcing the technician to perform additional troubleshooting.

If the DHCP session is successful, the modem proceeds to download the configuration file from the Trivial File Transfer Protocol (TFTP) server which defines the subscriber's maximum Download and Upload speeds, Quality of Service (QoS) and Encryption settings. The Time of Day (ToD) server will also provide a timestamp to the modem if required.

Finally, the modem sends a registration request to the CMTS including a list of its configuration properties. If the CMTS approves the settings, a successful registration response is generated. If the CMTS does not approve the settings, the registration request is rejected, and the modem will not be able to go online and transmit data.

IP	Link	Events
CM IP	192.168.20.6	
Subnet	255.255.255.0	
DHCP Server	192.168.1.10	
Router IP	192.168.20.1	
TFTP IP	192.168.1.10	
Config File	CBE301_TES	18:25:26 Configuration File PASS
ToD IP	192.168.1.10	18:25:24 Time Of Day PASS
Client IP	192.168.18.2	18:25:24 Configuration File In Prog
Gateway	192.168.18.1	18:25:24 TFTP PASS
Subnet	255.255.255.0	18:25:22 TFTP In Progress...
DNS	206.13.28.12	18:25:22 Time Of Day In Progress.
		18:25:21 CM DHCP PASS
		18:25:21 CM DHCP OK...

Baseline Privacy Infrastructure (BPI+) implemented by many cable operators, is used to encrypt and protect subscriber data and prevents non-paying subscribers from receiving service. The BPI registration process, when enabled, occurs immediately after the modem registers with the CMTS.

For diagnostic purposes, the built-in modem reports the entire registration process via intuitive screens and messages. A complete sequence of events and a log of IP addresses is displayed so the technician knows exactly what to look for rather than trying to understand all the intricacies of the registration process.

DOCSIS® 3.0/EuroDOCSIS 3.0 Cable Modem Emulation (CX150-D3+/CX180-D3+)

An embedded cable modem incorporating state-of-the-art technology, supports full upstream and downstream channel bonding, IPv6 addressing and Advanced Encryption Standard (AES) encryption used in next generation DOCSIS 3.0 and EuroDOCSIS 3.0 networks.

Dynamic bandwidth adjustment quickly allows technicians to lock to the channel bonding profile in service, so that up to four Upstream and eight Downstream channels can be tested including legacy single channel systems. Customers operating hybrid networks will benefit from the dual band design that supports both 8MHz, Annex A and 6MHz, Annex B modulation types and associated symbol rates.

Fitted with a Gigabit Ethernet interface, complete CPE emulation is achieved when the unit is configured in Pass Through mode. Technicians are able to perform full Triple Play service testing and troubleshooting at the highest possible bandwidth levels at both RF (WAN) and Ethernet (LAN) interfaces. The fast and reliable Internet connection provided by the modem can also be used to remote control the unit or it can be used to exchange test profiles and data between a server equipped with Reveal Productivity Suite software.

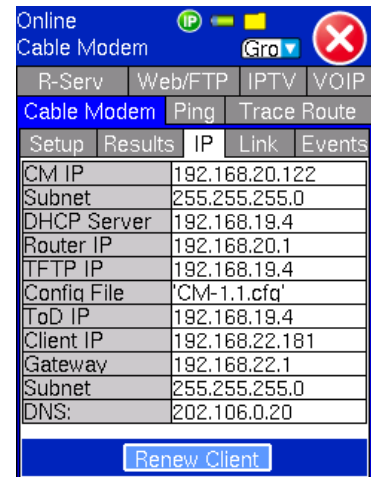
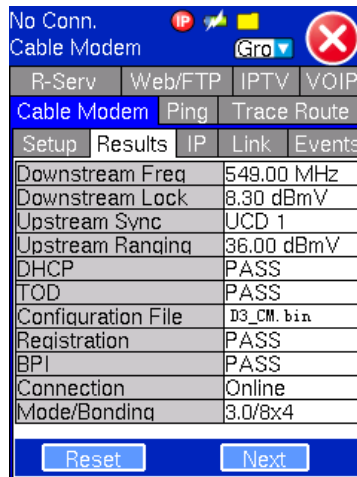
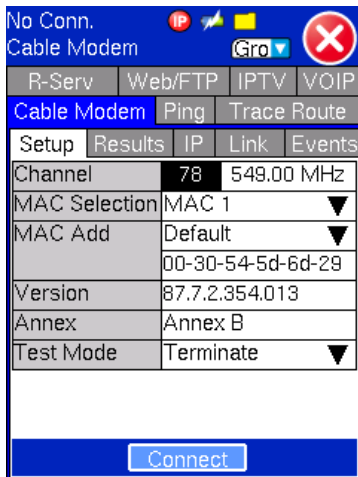

Link Statistics

Data rates up to 320Mbps Downstream and 160Mbps Upstream are supported and verified. The Transmit and Receive parameters of the modem including Frequency, Power level, SNR, Pre/Post BER, and Symbol rate are evaluated for each bonded channel. Dedicated Result tabs for Downstream and Upstream channels allows technicians to view bandwidth performance quickly and identify problematic channels or groups easily.

Channel Bonding

DOCSIS 3.0/EuroDOCSIS 3.0 technology provides a number of enhancements, most notably, channel bonding. Because channel bonding can be implemented independently on upstream channels or downstream channels, technicians quickly need to know these details when testing out in the field. The ability to do a quick spot check of frequency and power level in the Downstream provides a valuable insight into whether channels are balanced across the Downstream Bonding Group (DBG).

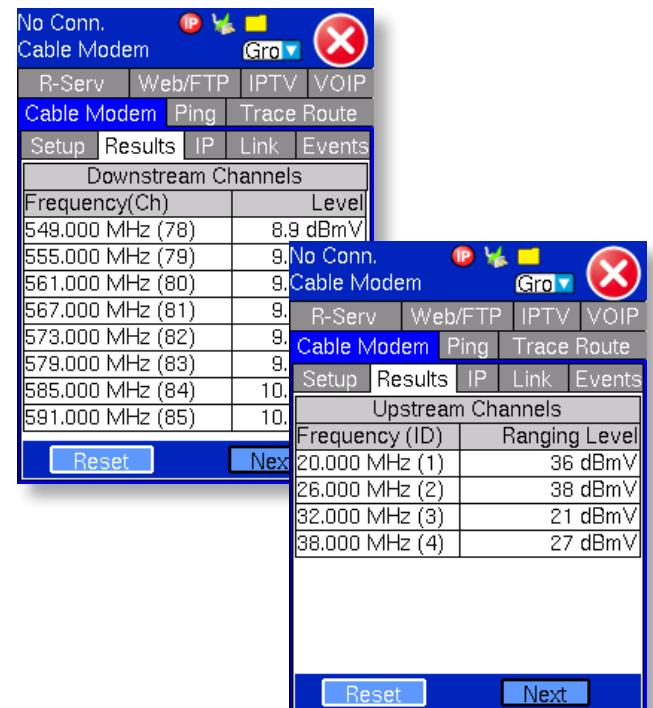

Advanced IP Testing

Triple Play services are IP centric, so IP test functions are no longer considered a luxury. On a daily basis, technicians verify network connections during service installation and restoration, so Ping test, Trace Route, ARP, Web browser, FTP throughput, VoIP Call emulation and IPTV measurement have become routine measurements. IP verification on the CX series is possible over the DOCSIS Cable Modem and Ethernet management test ports, while a subset of these tools is available using the USB WiFi adaptor.

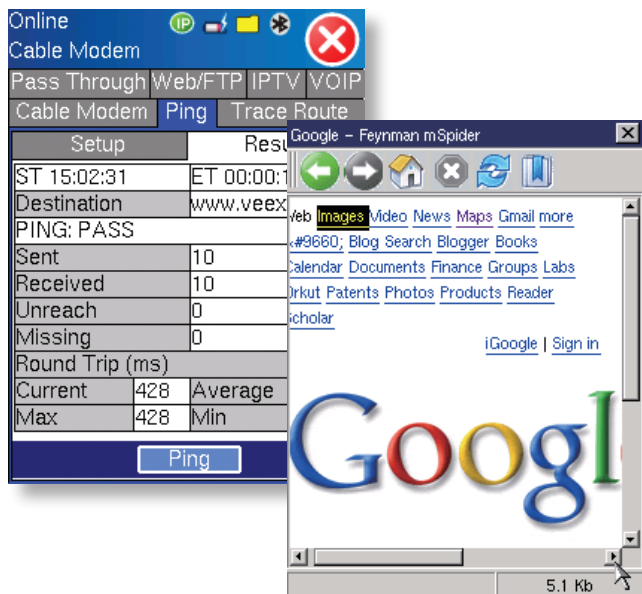

IPTV Service Verification

Designed and optimized for technicians turning up IP video service. Set-Top Box (STB) emulation includes registration, IGMP and RTSP signaling for Broadcast and Video on Demand (VOD) applications. Transport stream analysis encompasses data/video/audio bit rates and Program Identification (PID) mapping. Packet jitter and loss, IGMP latency (channel zapping), PCR statistics and Viewer function complete the Video Quality of Service (QoS) application suite.

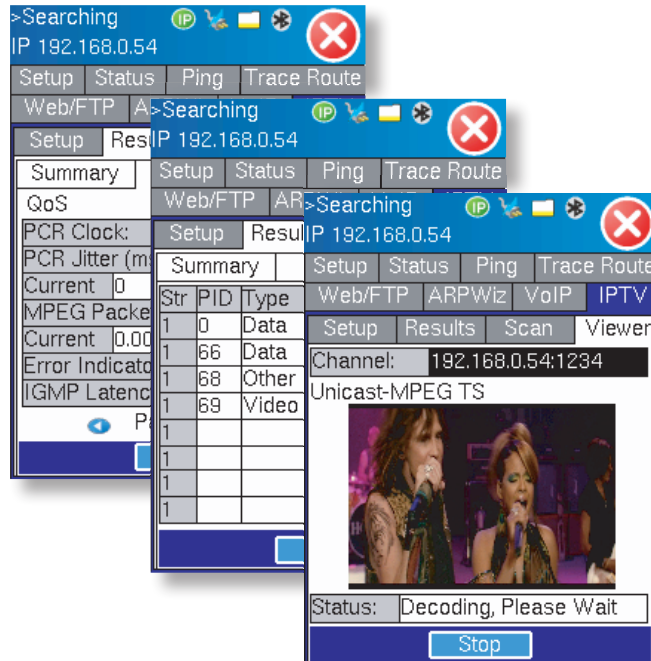

VoIP Testing

Take advantage of the three software options offering different test methods to verify and provision your VoIP network. Testing can be performed over any of the Ethernet or DOCSIS test ports.

VoIP Check – Simulates a VoIP call to the nearest router and measures the round trip MOS score and related VoIP parameters.

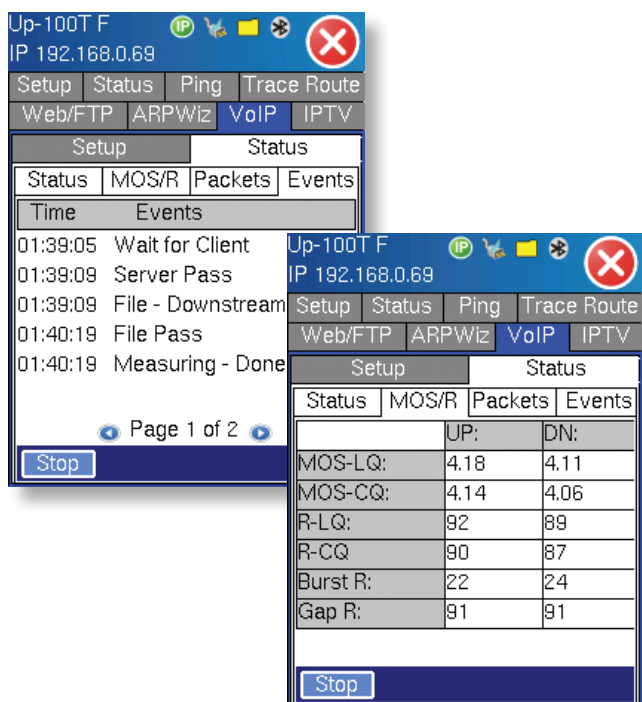

VoIP Expert – Generates industry standard wave files to verify MOS and R-factor values of upstream and downstream paths and includes QoS measurements such as packet jitter, packet loss, and delay. Compatible with all VeEX testers including VX1000 VoIP server software.

VoIP Call Expert – Emulates an IP phone and can place and receive calls using SIP or H.323 protocols. Comprehensive Codec support and call destination options verify voice encoding and translation provisioning. Real-time evaluation of subjective voice quality (MOS and R-factor) is made possible using the Telchemy® test method.

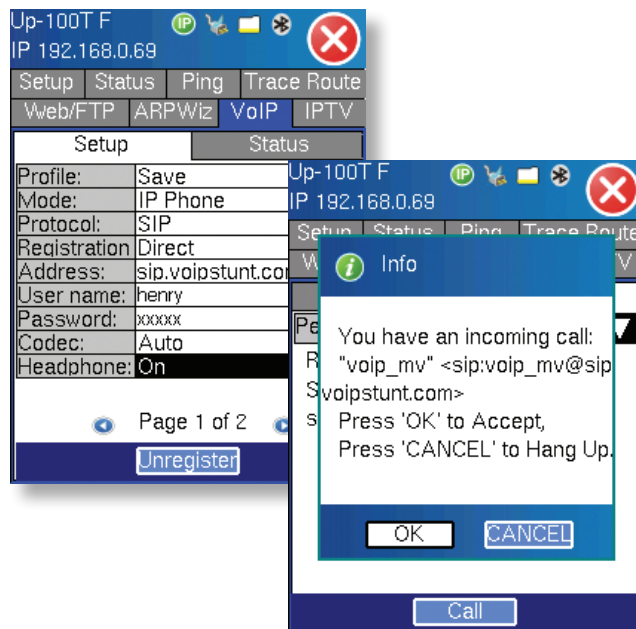

Net Wiz

Ethernet network installation is simplified using this basic, yet powerful feature. A built-in TDR identifies distance to short, distance to open, wire cross, and other anomalies associated with CAT-5 structured cabling. "Sniff" the network using the one-touch discovery feature. Identify routers, gateways, printers, PCs and other devices connected to the network within seconds.

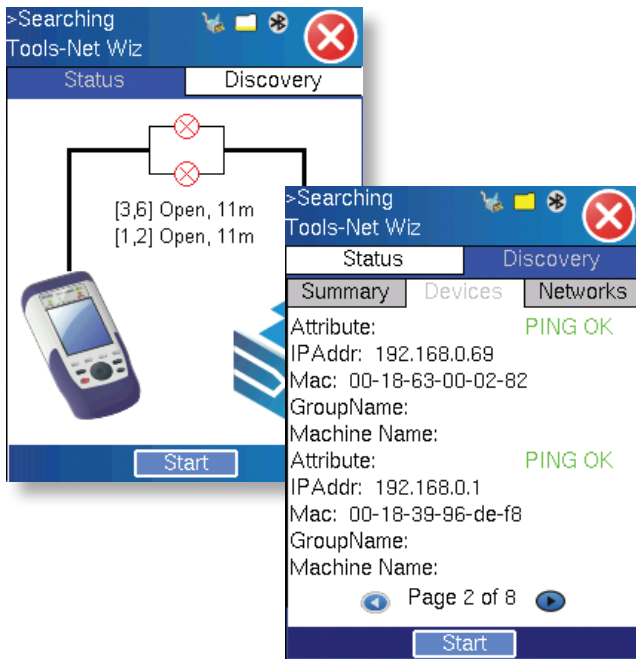

WiFi Wiz

All VePAL products adopt a USB WiFi adaptor to make 802.11 b/g wireless installations a simple task. Scan for available networks or perform signal strength and quality measurements to determine the best location for a new wireless access point. The IP Ping capability ensures the wireless network is properly installed and configured. A full suite of IP testing features is supported.

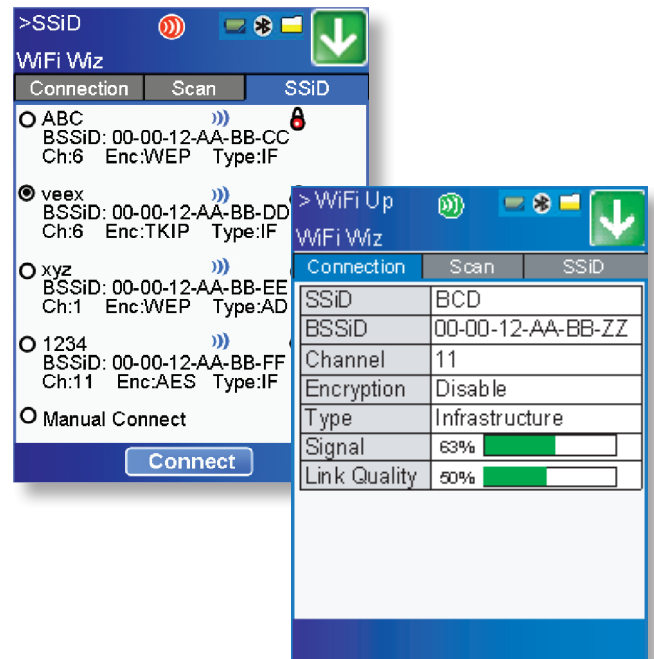

Bluetooth

All VePAL products support a micro USB Bluetooth adaptor offering a wireless connectivity up to 10 meters or 30 feet. Ultra compact and portable, the adaptor provides an untethered connection between the test set and other Bluetooth compatible devices such as a Notebook PC or cell phone, so a technician can transfer test result files quickly and easily without having to bother with memory sticks or Ethernet connections.

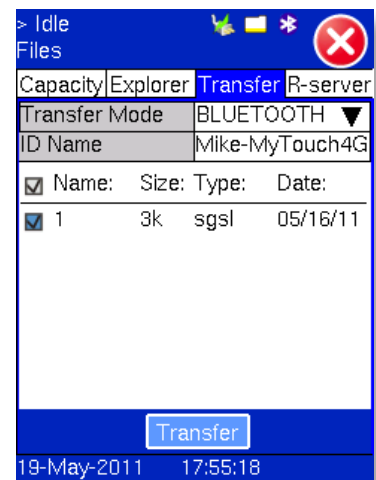
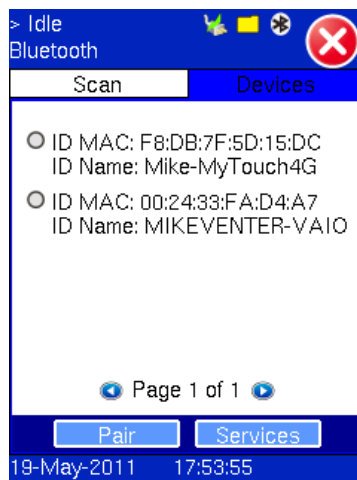
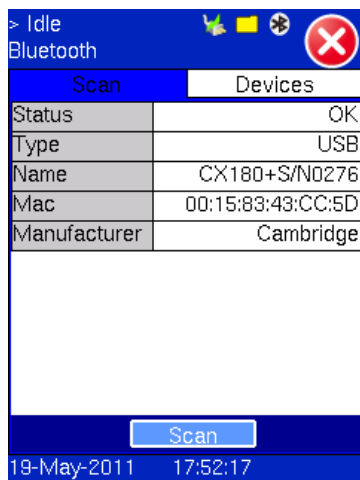
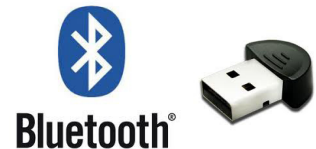

ReVeal Server Productivity Suite

A software application specifically designed for medium-to-large CATV operators facing the enormous challenge of coordinating hundreds of installations per day, collecting the field test results for billing/record purposes and having to maintain a large inventory of test sets in parallel. When used in conjunction with the Home Installation Process (HIP) and Signature Pad features, the application becomes a powerful tool to reduce customer call-backs and associated truck rolls, maximizing workforce efficiency and lowering operational costs.

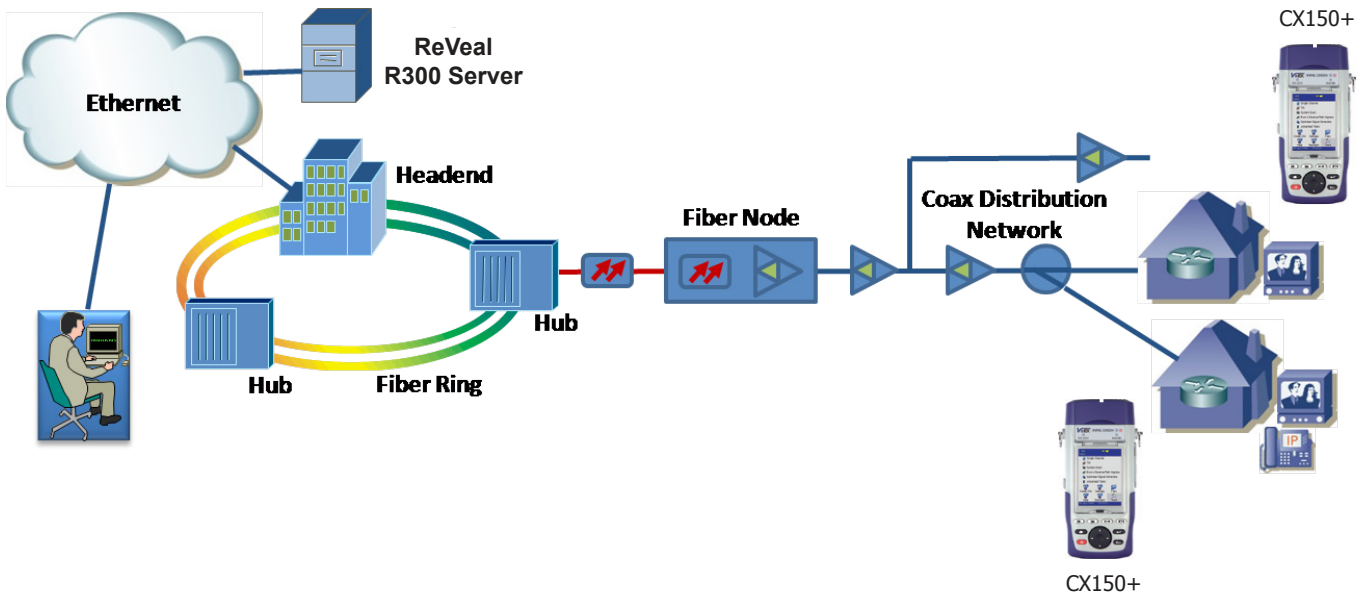

Home Installation Process (HIP)

A customized test procedure that can be downloaded and programmed into each test set. The step-by-step script eliminates guesswork and rogue installation practices ensuring consistent service turn-up and delivery. This disciplined technique ensures the "Birth Certificate" of each new installation conforms to operating guidelines and ISO quality standards.

Advanced Management

Authorized test sets register with specific ReVeal R300 Server/s to download new channel tables, test profiles, measurement thresholds and job cards. Test results can be uploaded via LAN interface or DOCSIS connection running over the existing RF network. Signature Pad electronically captures the customer signature which is automatically appended to the test results upon work order completion.

Benefits

- Centralized storage of test profiles, software versions, and measurement thresholds
- Registered test sets are informed of new test profiles, software versions and channel tables
- Test set software versions are maintained and synchronized
- Results are collected electronically while technician is on site, thus billing transactions can be processed sooner
- Operates with Operator and Contractor owned test sets giving operational statistics for both activities
- Provides theft prevention, test set lockout, time lock and other security features

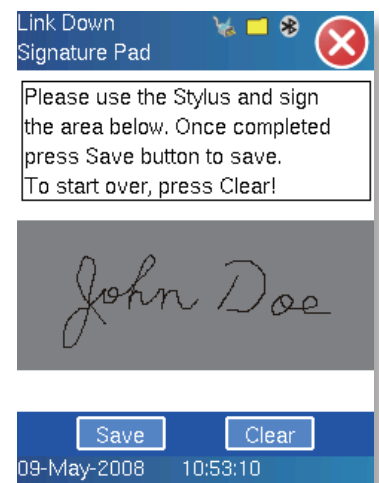

ReVeal CX PC Tool

A software package shipped standard with each CX test set. Channel tables, location thresholds, and other installation data can be created and edited on a PC for upload to the test set via USB, LAN or DOCSIS connection. Test results can be downloaded and saved to a PC, where test data management and report generation can be performed. Users are able to check and upgrade their test sets without having to return the unit to the supplier, thus reducing downtime.

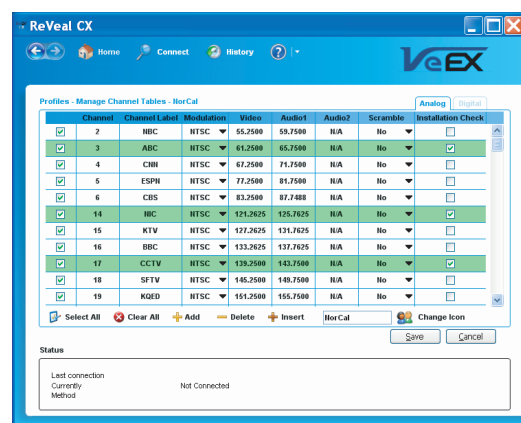

Measurements

Frequency Range: 5 to 1000MHz

Level Input Range

- -45 dBmV to +55 dBmV (CX180+)
- -40 dBmV to +55 dBmV (CX series)

Level Accuracy: ± 1.5 dB typical

Amplitude Resolution: 0.1dB

Downstream Modulation: 64/256 QAM Annex A/B/C

Digital Lock Range²: -15dBmV to +50 dBmV

C/N Range: 45db (CX series); 50 dB (CX180+)

C/N Accuracy: ± 2.0 dB typical

MER: 21 to 40dB (± 1.5 dB typical)

Downstream BER Range: 1×10^{-9} to 9×10^{-3}

Input Impedance: 75 Ω

Single Channel Measurements

Analog signal measurements: Video and audio Power level, Video-to-audio ratio, adjacent channel ratio, C/N ratios

Digital signal measurements: QAM power level, MER, Pre/Post BER, constellation, deep interleave, adjacent channel ratio

Installation Check

Measurement locations: Tap, Ground Block, Set-Top Box

Analog measurements: Up to 12 channels per channel table (including tilt, peak-to-valley, min/max video level, min/max video-to-audio ratio, min/max C/N ratio, max adjacent channel ratio)

Digital measurements: Up to 12 channels per channel table (including tilt, peak-to-valley, min/max QAM level, min/max MER, max adjacent channel ratio, pre-BER, post-BER)

System Scan

Scan on all channels in the active channel plan

Analog measurements: Video and audio power levels, video-to-audio ratio, adjacent channel ratio, C/N ratio, tilt, peak-to-valley, min/max video level, min/max video-to-audio ratio, min/max C/N ratio, max adjacent ratio

Digital measurements: QAM power level, adjacent channel ratio, tilt, peak-to-valley values, min/max QAM level, max adjacent channel ratio

Forward and Reverse Path Ingress Scan

Forward

- Scan Range: 54/108MHz¹ to 1000MHz
- Resolution: minimum 62.5kHz (CX180+), 250kHz (CX series)

Reverse

- Scan Range: 5 to 42MHz /65MHz¹
- Resolution: minimum 125kHz (CX180+), 250kHz (CX series)

Forward and Reverse

- Resolution Bandwidth
125kHz, 330kHz, 1MHz (CX180+)
250kHz (CX series)
- Attenuation Range: 0 to 50dB, 10dB/step
- Range with Attenuation
-45dBmV to +55dBmV (CX180+)
-40dBmV to +55dBmV (CX series)
- Dynamic Range: 50dB (CX180+), 45dB (CX series)

Reverse Path QAM Analysis (CX180+)

Requires CX120+ or CX180+ with USG+FEC option

Reverse scan range: 5 to 42MHz/65MHz¹

Minimum lock level: -5dBmV

QAM level, MER, pre/post BER

Constellation diagram

Upstream Signal Generator (CX120+/CX150+/CX180+)

Modulation: QPSK, QAM 16/64/256, CW

Output signal level: 5 to 58dBmV (CW typical)

Frequency range: 4 to 42MHz/65MHz¹, 1MHz step

QAM 16/64/256 modulation with continuous FEC (CX120+/CX180+)

Cable Modem (CX150+/CX180+)

DOCSIS 2.0 & EuroDOCSIS¹ 1.0/1.1/2.0 compliant

Downstream/Receiver

- Modulation: QAM64/256
- Frequency Range: 88 to 860MHz / 108 to 862MHz
- Bandwidth: 6MHz/8MHz
- Input Signal Level²: -15 to +15dBmV

Upstream/Transmitter

- Modulation: QPSK, QAM16/32/64/128
- Frequency Range: 5 to 42MHz/65MHz¹
- Output Signal Level: +8 to +58dBmV (depends on Modulation)

Cable Modem (CX150-D3+/CX180-D3+)

DOCSIS/EuroDOCSIS 3.0/2.0/1.1 compliant

Downstream/Receiver

- Demodulation: QAM64/256/1024
- Frequency Range
 - DOCSIS: 88MHz to 1002MHz
 - EuroDOCSIS: 108MHz to 1002MHz
- Maximum Speed: 320Mbps (EuroDOCSIS with 8 D/S bonding)
- Channel Bonding: Up to 8 channels (contiguous or non-contiguous)
- Bandwidth
 - DOCSIS: 6MHz
 - EuroDOCSIS: 8MHz
- Input Power Level: -15dBmV to +15dBmV

Upstream/Transmitter

- Modulation: QPSK, QAM-8/16/32/64/128
- Frequency Range
 - DOCSIS: 5 to 42MHz
 - EuroDOCSIS: 5 to 65MHz
- Maximum Speed: 160Mbps (EuroDOCSIS with 4 U/S bonding)
- Channel Bonding: Up to 4 channels
- Output Signal Level
 - QAM32/64: +8 to +54dBmV
 - QPSK: +8 to +58dBmV
 - S-CDMA: +8 to +53dBmV

General

- IPv4 and IPV6 support
- DHCP client obtains IP and DNS server address from DHCP server automatically
- Time of Day (ToD) support for local and MSO time synchronization
- TFTP Client support for cable modem configuration file download
- Security: BPI+ and AES support
- Pass-Through testing (1000BaseT port): Verify high bandwidth data transfer between PC and Network

Notes

¹ Annex A

² Typical range with QAM-64 modulation

Advanced IP Testing

Ping, Trace Route, ARP, FTP/Web tests. These are done via the chassis 10/100-T port or via Cable Modem emulation (CX150+/CX180+).

VoIP Testing

VoIP Check

- Simulates VoIP call to the nearest router/CMTS
- Round Trip MOS score

VoIP Expert

- MOS and R-factor measurement
- Packet Statistics: packet loss, jitter, delay

VoIP Call Expert

- VoIP call setup with VoIP USB adaptor
- Supports SIP and H.323 protocols
- Codex: G.711U, G.711A, G.723, G.729, Auto

IPTV

Provides true STB emulation

Analyze up to three streams simultaneously

Supports IGMP/RTSP signaling, MPEG-2, H.264 and VC1 video compression, MPEG-2 and RTP transport streams

Video and Audio bit rates and statistics

Channel zapping for quick and complete installation check

NetWiz

Available on 10/100-T chassis port

Detect distance to open/short, wire cross, impedance mismatch

Network device discovery

Auto Ping verification

WiFi Wiz

Supports 802.11 b/g

SSID detection, infrastructure, Ad-hoc, and encryption

Signal strength and signal quality

IP connectivity (Ping, Trace Route, FTP upload/download, Web Test, VoIP Check and VoIP Expert)

General Specifications

Size	210 x 100 x 55 mm (H x W x D) 8.25 x 3.75 x 2.25 in
Weight	Less than 1 kg (less than 2.2 lb)
Battery	Lilon smart battery, 2600mAh, 10.8VDC
Operating Time	Standard > 4 hours, Standby > 12 hours Extended > 8 hours, Standby > 24 hours
AC Adaptor	Input: 100-240 VAC, 50-60 Hz Output: 15VDC, 3.5A
Operating Temperature	-10°C to 45°C (14°F to 113°F)
Storage Temperature	-20°C to 70°C (-4°F to 158°F)
Humidity	5% to 95% non-condensing
Display	3.5" QVGA 320x240 full color touch-screen
Ruggedness	Survives 2 m (6 ft) drop to concrete on all sides
Water resistance	May be used in light rain
Interfaces	USB 2.0, RJ45, 10/100-T Ethernet, Bluetooth (optional)
Languages	Multiple languages can be supported
Power up time	Less than 20 seconds

CX100+

Z02-00-008P VePAL CX100+ CATV Signal Analyzer
Unit (select one):
 Z02-04-001P VePAL CX100+ CATV Signal Analyzer, Annex B
 Z02-04-002P VePAL CX100+ CATV Signal Analyzer, Annex A
 Z02-04-003P VePAL CX100+ CATV Signal Analyzer, Annex A+B

CX110+

Z02-00-011P VePAL CX110+ CATV Signal Analyzer
Unit (select one):
 Z02-04-004P VePAL CX110+ CATV Signal Analyzer, Annex B
 Z02-04-005P VePAL CX110+ CATV Signal Analyzer, Annex A
 Z02-04-006P VePAL CX110+ CATV Signal Analyzer, Annex A+B

Upranging Hardware (must select one):

Z66-00-017P Upranging, Annex B
 Z66-00-018P Upranging, Annex A
 Z66-00-019P Upranging, Annex A+B

CX120+

Z02-00-012P VePAL CX120+ CATV Signal Analyzer
Unit (select one):
 Z02-04-007P VePAL CX120+ CATV Signal Analyzer, Annex B
 Z02-04-008P VePAL CX120+ CATV Signal Analyzer, Annex A
 Z02-04-009P VePAL CX120+ CATV Signal Analyzer, Annex A+B

AUX Hardware (must select one):

Z66-00-004P QAM16/64/128/256 USG with FEC option

CX150+

Z02-00-013P VePAL CX150+ CATV Signal Analyzer
Unit (select one):
 Z02-04-010P VePAL CX150+ CATV Signal Analyzer, Annex B
 Z02-04-011P VePAL CX150+ CATV Signal Analyzer, Annex A
 Z02-04-012P VePAL CX150+ CATV Signal Analyzer, Annex A+B

Cable Modem Hardware (select one):

Z66-00-003P Standard USG, CM Annex B
 Z66-00-009P Standard USG, CM Annex A
 Z66-00-010P Standard USG, CM Annex A+B

CX180+

Z02-00-014P VePAL CX180+ CATV Signal Analyzer
Unit (select one):
 Z02-04-013P VePAL CX180+ CATV Signal Analyzer, Annex A+B

AUX Hardware (must select one):

Z66-00-004P QAM16/64/128/256 USG with FEC option
 Z66-00-024P DOCSIS 2.0 Modem Emulation Annex B with Standard USG
 Z66-00-025P DOCSIS 2.0 Modem Emulation Annex A with Standard USG
 Z66-00-026P DOCSIS 2.0 Modem Emulation Annex A+B with Standard USG
 Z66-00-053P* CX180 OFDM option

CX150-D3+

Z02-00-018P VePAL CX150-D3+ CATV Signal Analyzer, DOCSIS 3.0 Cable Modem, Annex A+B

Unit (select one):

Z02-04-015P VePAL CX150-D3+ CATV Signal Analyzer, Annex B
 Z02-04-016P VePAL CX150-D3+ CATV Signal Analyzer, Annex A
 Z02-04-017P VePAL CX150-D3+ CATV Signal Analyzer, Annex A+B

CX180-D3+

Z02-00-019P VePAL CX180-D3+ CATV Signal Analyzer, DOCSIS 3.0 Cable Modem Emulation, Annex A+B with Standard USG

Interfaces/Test Options

499-05-039 Reverse Path QAM Signal Analysis (CX180+/CX180-D3+ only)
 499-05-072 Advanced Management
 499-05-073 Home Installation Process
 499-05-118* In Service Forward Path Sweep (CX180+/CX180-D3+ only)
 499-05-126 RP Balancing (requires Cable Modem or USG+FEC hardware option)
 Z33-00-009 Remote View, incl. Remote Control option
 Z33-00-010* Return Path Sweep, incld Remote View and Remote Control options (requires USG+FEC hardware option)

Additional Options

(via USB, 10/100 Base-T Management Port)

499-05-001 Web Browser (requires Advanced IP option)
 499-05-002 NetWiz
 499-05-003 Remote Control
 499-05-008 IPTV Expert
 499-05-095 VoIP G.723 Codec
 499-05-096 VoIP G.729 Codec
 499-05-102 VoIP Check
 499-05-157 USB Data Card Support (for IP connection via Data Card modem and GPS)
 499-05-175 USB Bluetooth Dialing and File Transfer Support (USB Bluetooth adaptor not included)
 Z33-00-001 VoIP Expert, incl. VoIP Check
 Z88-00-001G WiFi Wiz, incl. USB WiFi Adaptor
 Z88-00-001P VoIP Call Expert, incl. VoIP USB Adaptor & Earpiece
 Z88-00-005G Advanced IP, incl. Ethernet Cable



VeEX Inc.
 2827 Lakeview Court
 Fremont, CA 94538 USA
 Tel: +1.510.651.0500
 Fax: +1.510.651.0505
 www.veexinc.com
 customercare@veexinc.com

© 2011 VeEX Inc. All rights reserved.
 VeEX is a registered trademark of VeEX Inc. The information contained in this document is accurate. However, we reserve the right to change any contents at any time without notice. We accept no responsibility for any errors or omissions. In case of discrepancy, the web version takes precedence over any printed literature.
 D05-00-014P F01 2011/08